

# GHIDINI

141  
142  
143  
144  
190  
239  
240  
2071  
7009  
7900  
7900  
2006 CUORE  
ARCHIMEDE  
ARIETE  
BAROCCO  
BRIXIA  
CARLO  
CARTER  
CARTESIO  
CARTESIO B/W  
CARTESIO Q  
CARTESIO Q B/W  
CLIP  
DELTA  
EASY  
EASY Q  
ELBA  
ELITE  
EUROPA 238  
FARFALLA  
FERGIE  
GABRY  
GALILEO  
GALILEO Q  
GINEVRA  
GM05  
GM07  
GM08  
GM10  
GM11  
GOLF  
IDEA  
IDEA Q  
ITACA 2005  
JOLLY 210  
LADY  
LEAF  
LEONARDO  
LINEA  
LITZ  
MILENA  
MILENA Z  
NION  
NION Q  
NOVECENTO  
PIGNA  
PIGNA 2008  
R5200  
R716

R716  
R771  
R775  
R901  
R938  
R988  
R988  
RIALTO  
SEVEN  
SEVEN  
SEVEN Q  
SEVEN Q  
SHARK  
SHARK  
SUSY - 2040  
SWING  
TIROL  
TOY Q  
UNIVERSAL  
UNO  
UNO  
UNO Z  
VICTORIA  
WING  
YORK  
YORK 4  
YORK BERRY  
YORK Q

**GHIDINI**

# Indice generale

# General index

Storia	6
Produzione	10
Sostenibilità	14
<b>1. MANIGLIE E COORDINATI PER PORTE E FINESTRE</b>	<b>18</b>
Alluminio galattico	26
Zama	36
Ottone	116
Alluminio	168
<b>2. SERRAMENTI</b>	<b>226</b>
DK / Cremonesi / Balcony door	228
Maniglioni per alzanti scorrevoli	308
<b>3. ACCESSORI PER PORTE E FINESTRE</b>	<b>316</b>
Rosette ottone	318
Nottolini ottone	326
Rosette e placche alluminio	329
Giochi DK	342
Ferri	343
Viti	346
<b>4. COORDINATI PER PORTE SCORREVOLI</b>	<b>348</b>
Alluminio galattico	350
Zama	352
Ottone	359
Alluminio	361
<b>5. ALLUMINIO GALATTICO</b>	<b>366</b>
Maniglie + dk	368
Maniglioni per alzanti scorrevoli	374
Maniglie per porte scorrevoli	375
Maniglioni fissi	377
<b>6. ARTICOLI SMART</b>	<b>378</b>
Maniglie + dk	380
Maniglie per porte scorrevoli	403
<b>7. PORTE D'INGRESSO</b>	<b>406</b>
Pomoli	408
Maniglioni fissi	415
Battenti	420
Rosette - bocchette - placche per porte blindate	422
Maniglie singole	428
Nottolini limitatori d'apertura per porte blindate	430
Kit per porte basculanti	433

<b>8. ACCIAIO INOX</b>	<b>434</b>
Maniglie + dk	438
Accessori	442
Maniglioni fissi	443
<b>9. NYLON</b>	<b>446</b>
Maniglie + cremonesi	452
Accessori	462
Maniglioni fissi	464
Pomoli	465
Appendiabiti	466
Copri avvolgibili	467
<b>10. COORDINATI E COMPLEMENTI D'ARREDO</b>	<b>468</b>
Ganci rigidi	470
Cricchetti	470
Pinze fermaporte	471
Copri avvolgibili	471
Fermaporte	472
Supporti	473
Piedini	474
Maniglette ponte	475
<b>11. ACCESSORI PER INFISSI ESTERNI</b>	<b>476</b>
Arsenio	478
Ometti	479
<b>12. METALMEC</b>	<b>486</b>
<b>13. ESPOSITORI</b>	<b>492</b>
<b>14. APPROFONDIMENTI</b>	<b>498</b>
Riepilogo finiture	500
Resistenza alla corrosione	501
Ghi.co.tec	502
G-Plus	504
Avvertenze	506
Condizioni Generali di Vendita	508
Contatti	514

History	6
Production	10
Sustainability	14
<b>1. DOOR HANDLES AND DOOR AND WINDOW ACCESSORIES</b>	<b>18</b>
Galactic Aluminum	26
Zamak	36
Brass	116
Aluminum	168
<b>2. WINDOWS</b>	<b>226</b>
DK / Window handles / Balcony door	228
Pull handle for sliding door	308
<b>3. ACCESSORIES FOR DOORS AND WINDOWS</b>	<b>316</b>
Brass roses	318
Brass knobs	326
Aluminum roses and plates	329
DK mechanism	342
Spindles	343
Screws	346
<b>4. SLIDING DOOR ACCESSORIES</b>	<b>348</b>
Galactic Aluminum	350
Zamak	352
Brass	359
Aluminum	361
<b>5. GALACTIC ALUMINUM</b>	<b>366</b>
Handles + dk	368
Pull handle for sliding door	374
Sliding door handles	375
Pull handles	377
<b>6. SMART PRODUCTS</b>	<b>378</b>
Handles + dk	380
Sliding door handles	403
<b>7. ENTRANCE DOORS</b>	<b>406</b>
Knobs	408
Pull handles	415
Door knockers	420
Accessories	422
Single handles	428
Knobs for opening limiting device armored doors	430
Garage door handle kit	433

<b>8. STAINLESS STEEL</b>	<b>434</b>
Handles + dk	438
Accessories	442
Pull handles	443
<b>NYLON</b>	<b>446</b>
Handles	452
Accessories	462
Pull handles	464
Knobs	465
Coat hangers	466
Plates for roller shutters	467
<b>10. ACCESSORIES AND FURNITURE FITTINGS</b>	<b>468</b>
Door hooks	470
Ratchet windows	470
Door stopper clamp	471
Plates for roller shutters	471
Doorstop	472
Handrail supports	473
Brass adjusting screw	474
Bridge handles	475
<b>11. WINDOWS ACCESSORIES EQUIPMENT</b>	<b>476</b>
Arsenio	478
Ometti	479
<b>12. METALMEC</b>	<b>486</b>
<b>13. DISPLAY UNITS</b>	<b>492</b>
<b>14.IN_DEPTH STUDY</b>	<b>498</b>
Finishing summary	500
Corrosion resistance	501
Ghi.co.tec	502
G-Plus	504
Warnings	506
General Terms and Conditions of Sales	508
Contact	514

# Storia

Dal 1929 GHIDINI PIETRO BOSCO rappresenta una lunga storia di maniglie e coordinati.

Lo sviluppo dell'azienda si inserisce nell'operosa tradizione artigianale ed industriale che caratterizza la Val Trompia situata a nord del capoluogo Brescia nell'Italia settentrionale.

Il soprannome "BOSCO" indicava la località nei pressi della cascina di proprietà di Pietro Ghidini e fu attribuito alla famiglia per distinguerla dai numerosi ceppi omonimi della zona.

Nel 1951 ebbe inizio la specializzazione nella produzione di maniglie che fino ad allora era affiancata alla produzione di posate.

Alla fine degli anni '60 venne edificato lo stabilimento che rappresenta tuttora la sede: da evidenziare l'idea lungimirante di individuare un'area alla confluenza tra due corsi d'acqua che consentirono la realizzazione di un bacino idroelettrico per l'autoproduzione di una parte dell'energia impiegata nei processi produttivi.

Negli anni il costante processo di innovazione tecnologica non si è mai arrestato.

Da ricordare l'operazione che nel 2004 ha portato all'acquisizione di un'azienda specializzata nella produzione di maniglie in alluminio anodizzato che ha dato origine alla divisione denominata GHIDINI ALUMINIUM.

Oggi GHIDINI rappresenta sicuramente un valido riferimento per il settore proponendo un catalogo di soluzioni tecniche e formali per maniglie e coordinati in ottone, lega di zinco (ZAMA), alluminio a cui si affiancano proposte in acciaio inox, nylon e ferro.

# History

Since 1929 GHIDINI PIETRO BOSCO has represented a long history of handles and coordinated products.

The company's development is part of the industrious artisan and industrial tradition that characterizes Val Trompia, located north of the capital Brescia in northern Italy.

The nickname "BOSCO" indicated the location near the farmhouse owned by Pietro Ghidini and was attributed to the family to distinguish it from the numerous homonymous lineages in the area.

In 1951, the specialization in the production of handles began, which until then had been accompanied by the production of cutlery.

At the end of the 1960s, the factory that is still the headquarters today was built: it is worth highlighting the far-sighted idea of identifying an area at the confluence of two waterways that allowed the creation of a hydroelectric basin for the self-production of part of the energy used in the production processes.

Over the years, the constant process of technological innovation has never stopped.

Worthy of mention is the operation that in 2004 led to the acquisition of a company specialized in the production of anodized aluminum handles, which gave rise to the division called GHIDINI ALUMINIUM.

Today GHIDINI certainly represents a valid reference for the sector by offering a catalogue of technical and formal solutions for handles and coordinated items in brass, zinc alloy (ZAMA), aluminium alongside proposals in stainless steel, nylon and iron.

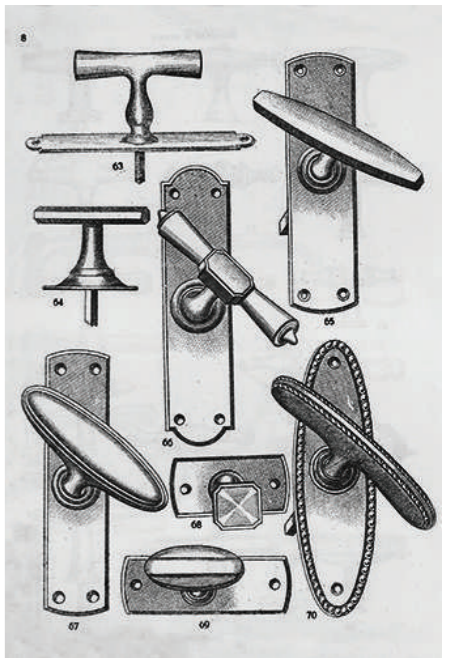
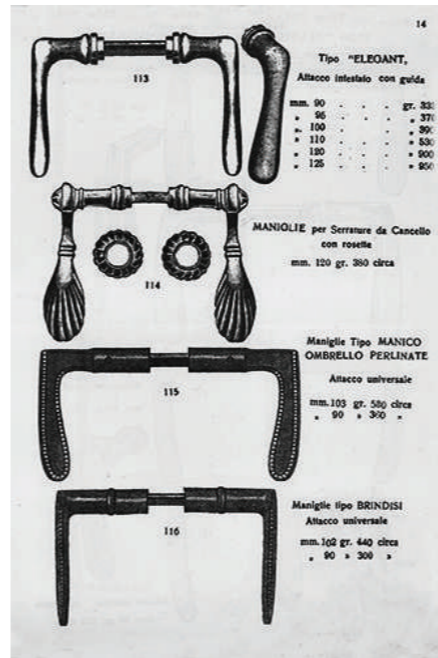

# Produzione

Fondata nel 1929, Ghidini Pietro Bosco è oggi alla terza generazione di gestione familiare, mantenendo intatti i valori che ne hanno segnato il successo.

Da sempre l'azienda ha saputo evolversi nel tempo, integrando tecnologie moderne e innovazione nel proprio settore. Ghidini Pietro Bosco si sviluppa in due siti produttivi, situati entrambi nella provincia di Brescia, zona con una lunga tradizione nella lavorazione del metallo.

Questa localizzazione strategica permette all'azienda di beneficiare dell'esperienza locale, assicurando al tempo stesso continuità operativa e qualità ai propri clienti.

Il controllo dei processi produttivi garantisce stabilità sia ai suoi collaboratori che ai suoi partner.

# Production

Founded in 1929, Ghidini Pietro Bosco is today in the third generation of the family business, keeping intact the values that have marked its success. The company has always been able to evolve over the time, integrating technologies and innovation in its sector.

Ghidini Pietro Bosco is spread across two production sites, both located in the province of Brescia, an area with a long tradition in metalworking. This strategic location allows the company to benefit from local know-how, while ensuring operational continuity and quality for its customers.

The control of the production processes guarantees stability both to its collaborators and its partners.

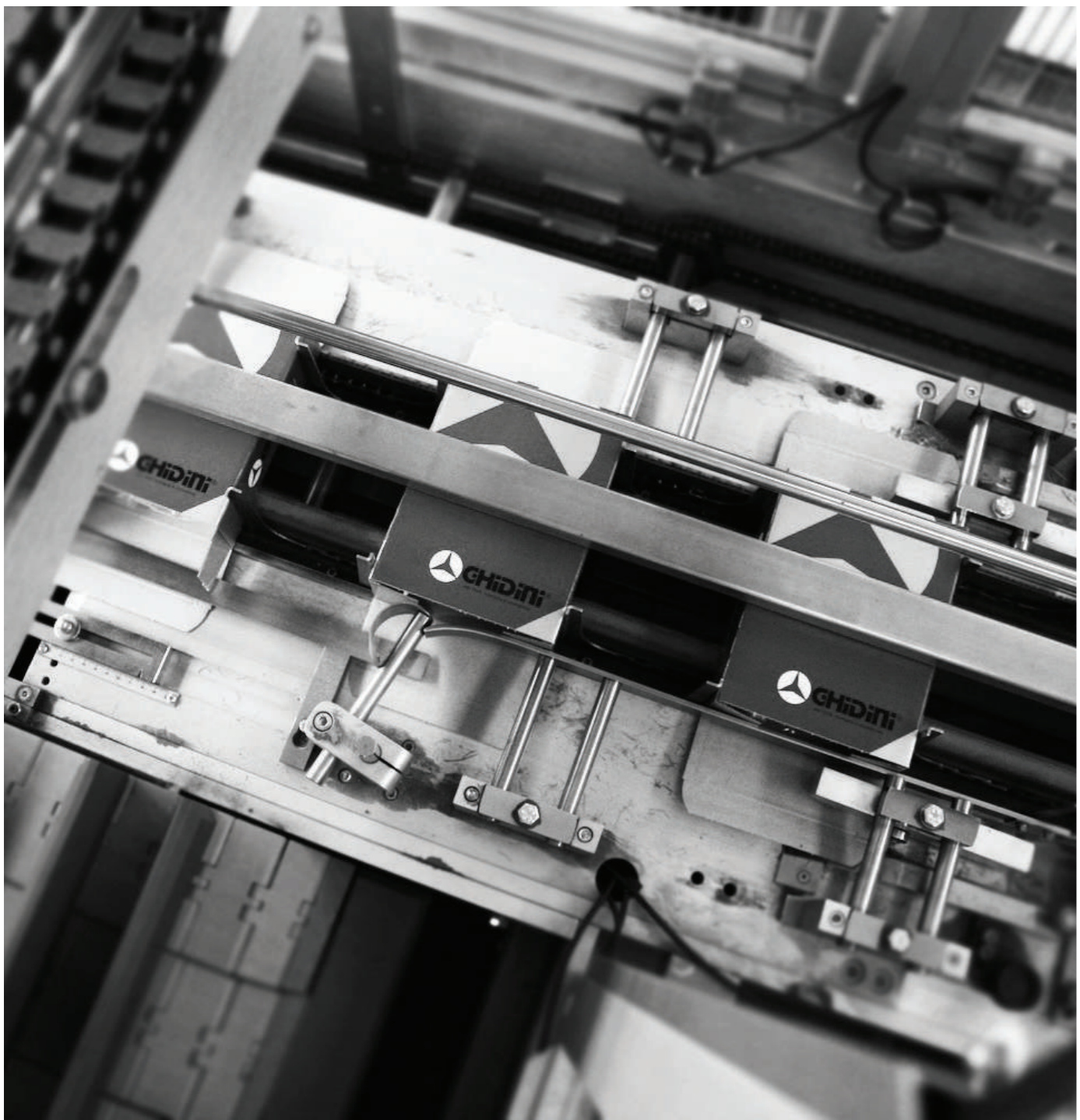

# Sostenibilità

L'attenzione alla sostenibilità è da sempre un principio fondamentale dell'azienda. Già dagli inizi degli anni 60 l'azienda dispone di una produzione idroelettrica tramite un bacino artificiale realizzato nei pressi della sede, ancora attivo. Un'attenzione lungimirante anche alla luce delle attuali sfide ambientali. I materiali utilizzati, il controllo dei processi secondo le normative più aggiornate e la scelta di un packaging riciclabile e volto a ridurre i volumi di trasporto, ci permettono di contribuire a un futuro più sostenibile.

Ghidini rispetta i requisiti di legge in materia ambientale e dispone dei permessi e delle autorizzazioni necessari che vengono periodicamente mantenuti aggiornati.

Ghidini sviluppa costantemente strategie atte a ridurre il consumo di risorse energetiche ed idriche e la produzione di rifiuti riducendo l'impatto ambientale delle proprie attività con sofisticati sistemi di depurazione ed impianti a circuito chiuso.

# Sustainability

Attention to sustainability has always guided our choices. Since the early 60s the company has had hydroelectric production via an artificial reservoir built near the headquarters, which is still active. A far-sighted focus also in light of current environmental challenges.

The materials used, the control of processes according to the most updated regulations and the choice of recyclable packaging aimed at reducing transport volumes, allow us to contribute to a more sustainable future.

Ghidini complies with environmental law requirements and has the necessary permits and authorizations which are periodically updated. Ghidini constantly develops strategies aimed at reducing the consumption of energy and water resources and the production of waste by reducing the environmental impact of its activities with sophisticated purification systems and closed-circuit plants.





# 1

## Maniglie e coordinati per porte e finestre

## Door handles and door and window accessories

20 Indice alfabetico maniglie / Alphabetical index handles  
22 Indice visual maniglie / Visual index handles

26 Alluminio galattico / Galactic Aluminum  
36 Zama / Zamak  
116 Ottone / Brass  
168 Alluminio / Aluminum

# Indice alfabetico maniglie

141	AL. GALATTICO	34	RIALTO	ZAMA	88
142	ALLUMINIO	174	SEVEN	ZAMA	90
143	ALLUMINIO	176	SEVEN	ALLUMINIO	210
144	ALLUMINIO	178	SEVEN Q	ZAMA	92
190	ALLUMINIO	180	SEVEN Q	ALLUMINIO	212
239	ALLUMINIO	182	SHARK	ZAMA	94
240	ALLUMINIO	184	SHARK	ALLUMINIO	214
2071	ALLUMINIO	222	SUSY - 2040	ALLUMINIO	216
7009	AL. GALATTICO	32	SWING	ZAMA	96
7900	ALLUMINIO	186	TIROL	OTTONE	164
7900	ALLUMINIO	188	TOY	ZAMA	98
2006 CUORE	ALLUMINIO	224	TOY Q	ZAMA	100
ARCHIMEDE	ALLUMINIO	190	UNIVERSAL	ALLUMINIO	218
ARIETE	OTTONE	122	UNO	OTTONE	166
BAROCCO	OTTONE	124	UNO	ALLUMINIO	220
BRIXIA	ALLUMINIO	192	UNO Z	ZAMA	102
CARLO	ALLUMINIO	194	VICTORIA	ZAMA	104
CARTER	ZAMA	42	WING	ALLUMINIO	106
CARTESIO	ZAMA	44	YORK	ZAMA	108
CARTESIO B/W	ZAMA	46	YORK 4	ZAMA	110
CARTESIO Q	ZAMA	48	YORK BERRY	ZAMA	112
CARTESIO Q B/W	ZAMA	50	YORK Q	ZAMA	114
CLIP	ZAMA	52			
DELTA	ALLUMINIO	196			
EASY	OTTONE	126			
EASY Q	OTTONE	128			
ELBA	OTTONE	130			
ELITE	OTTONE	132			
EUROPA 238	ALLUMINIO	198			
FARFALLA	ZAMA	54			
FERGIE	ZAMA	56			
GABRY	ALLUMINIO	200			
GALILEO	ZAMA	58			
GALILEO Q	ZAMA	60			
GINEVRA	OTTONE	134			
GM05	ZAMA	62			
GM07	ZAMA	64			
GM08	ZAMA	66			
GM10	ZAMA	68			
GM11	ZAMA	70			
GOLF	OTTONE	136			
IDEA	ZAMA	72			
IDEA Q	ZAMA	74			
ITACA 2005	ALLUMINIO	202			
JOLLY 210	ALLUMINIO	206			
LADY	OTTONE	138			
LEAF	ZAMA	76			
LEONARDO	ALLUMINIO	204			
LINEA	ZAMA	140			
LITZ	ZAMA	78			
MILENA	OTTONE	142			
MILENA Z	ZAMA	80			
NION	ZAMA	82			
NION Q	ZAMA	84			
NOVECENTO	OTTONE	144			
PIGNA	OTTONE	146			
PIGNA 2008	ALLUMINIO	208			
R5200	OTTONE	148			
R716	OTTONE	150			
R716	OTTONE	152			
R771	OTTONE	154			
R775	ZAMA	156			
R901	OTTONE	158			
R938	ZAMA	86			
R988	OTTONE	160			
R988	OTTONE	162			

# Alphabetical index handles

141	GALACTIC AL.	34	RIALTO	ZAMAK	88
142	ALUMINUM	174	SEVEN	ZAMAK	90
143	ALUMINUM	176	SEVEN	ALUMINUM	210
144	ALUMINUM	178	SEVEN Q	ZAMAK	92
190	ALUMINUM	180	SEVEN Q	ALUMINUM	212
239	ALUMINUM	182	SHARK	ZAMAK	94
240	ALUMINUM	184	SHARK	ALUMINUM	214
2071	ALUMINUM	222	SUSY - 2040	ALUMINUM	216
7009	GALACTIC AL.	32	SWING	ZAMAK	96
7900	ALUMINUM	186	TIROL	BRASS	164
7900	ALUMINUM	188	TOY	ZAMAK	98
2006 CUORE	ALUMINUM	224	TOY Q	ZAMAK	100
ARCHIMEDE	ALUMINUM	190	UNIVERSAL	ALUMINUM	218
ARIETE	BRASS	122	UNO	BRASS	166
BAROCCO	BRASS	124	UNO	ALUMINUM	220
BRIXIA	ALUMINUM	192	UNO Z	ZAMAK	102
CARLO	ALUMINUM	194	VICTORIA	ZAMAK	104
CARTER	ZAMAK	42	WING	ALUMINUM	106
CARTESIO	ZAMAK	44	YORK	ZAMAK	108
CARTESIO B/W	ZAMAK	46	YORK 4	ZAMAK	110
CARTESIO Q	ZAMAK	48	YORK BERRY	ZAMAK	112
CARTESIO Q B/W	ZAMAK	50	YORK Q	ZAMAK	114
CLIP	ZAMAK	52			
DELTA	ALUMINUM	196			
EASY	BRASS	126			
EASY Q	BRASS	128			
ELBA	BRASS	130			
ELITE	BRASS	132			
EUROPA 238	ALUMINUM	198			
FARFALLA	ZAMAK	54			
FERGIE	ZAMAK	56			
GABRY	ALUMINUM	200			
GALILEO	ZAMAK	58			
GALILEO Q	ZAMAK	60			
GINEVRA	BRASS	134			
GM05	ZAMAK	62			
GM07	ZAMAK	64			
GM08	ZAMAK	66			
GM10	ZAMAK	68			
GM11	ZAMAK	70			
GOLF	BRASS	136			
IDEA	ZAMAK	72			
IDEA Q	ZAMAK	74			
ITACA 2005	ALUMINUM	202			
JOLLY 210	ALUMINUM	206			
LADY	BRASS	138			
LEAF	ZAMAK	76			
LEONARDO	ALUMINUM	204			
LINEA	ZAMAK	140			
LITZ	ZAMAK	78			
MILENA	BRASS	142			
MILENA Z	ZAMAK	80			
NION	ZAMAK	82			
NION Q	ZAMAK	84			
NOVECENTO	BRASS	144			
PIGNA	BRASS	146			
PIGNA 2008	ALUMINUM	208			
R5200	BRASS	148			
R716	BRASS	150			
R716	BRASS	152			
R771	BRASS	154			
R775	ZAMAK	156			
R901	BRASS	158			
R938	ZAMAK	86			
R988	BRASS	160			
R988	BRASS	162			

# Indice visuale maniglie Visual index handles

## ALLUMINIO GALATTICO GALACTIC ALUMINUM



7009 32



141 34

## ZAMA ZAMAK



CARTER 42



CARTESIO 44



CARTESIO B/W 46



CARTESIO Q 48



CARTESIO Q B/W 50



CLIP 52



FARFALLA 54



FERGIE 56



GALILEO 58



GALILEO Q 60

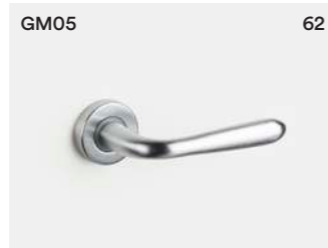

GM05 62



GM07 64



GM08 66



GM10 68



GM11 70



IDEA 72



IDEA Q 74



LEAF 76



LITZ 78



MILENA Z 80



NION 82



NION Q 84



R938 86



RIALTO 88



SEVEN 90



SEVEN Q 92



SHARK 94



SWING 96



TOY 98



TOY Q 100

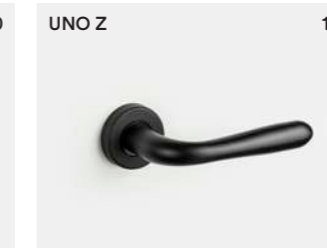

UNO Z 102



VICTORIA 104



WING 106



YORK 108



YORK 4 110



YORK BERRY 112



YORK Q 114

## OTTONE BRASS



ARIETE 122



BAROCCO 124

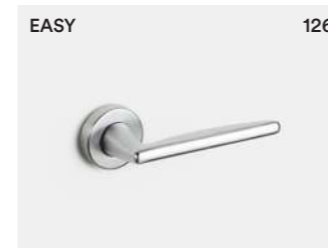

EASY 126

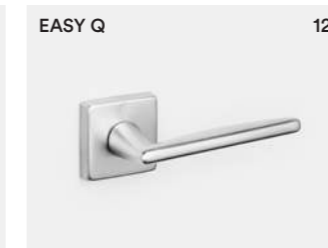

EASY Q 128



ELBA 130



ELITE 132

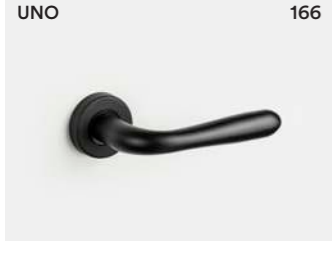
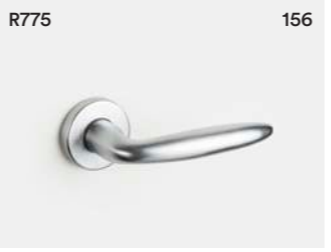

**ALLUMINIO  
ALUMINUM**

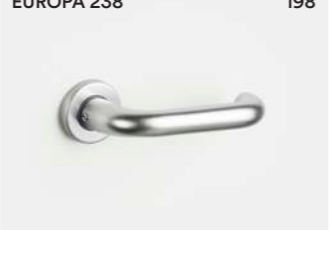
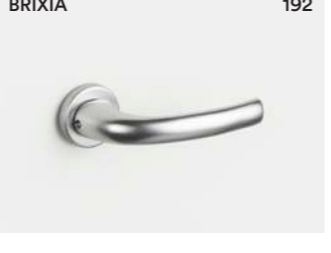
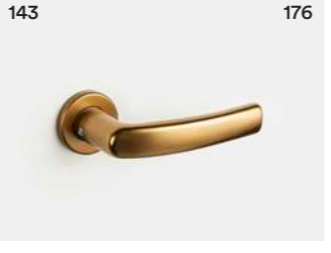

# Alluminio galattico

# Galactic Aluminum

28 Introduzione / Introduction  
30 Finiture / Finishes

32 7900  
34 141



Scopri le nuove finiture galattiche, disponibili per le maniglie 7900 e 141 e gli accessori dedicati. Una collezione completa che garantisce continuità di immagine.

Totalmente Made in Italy grazie alla produzione di prossimità, queste maniglie sono in alluminio, un materiale sostenibile e riciclabile.

L'alluminio è un materiale responsabile, grazie alla sua capacità di essere riutilizzato all'infinito con un basso consumo energetico, rendendolo fondamentale per un futuro più sostenibile.

La cosmesi del prodotto è studiata in modo da poter garantire lunga vita alle finiture e di conseguenza alle maniglie.

L'argento presente nella maniglia sprigiona gli ioni attivi che agiscono contro i batteri, dando il via ad un naturale e continuo processo antibatterico.

Find out the new galactic finishes, available for models 7900 and 141 and their coordinated accessories. A complete collection of handles that ensures a continuity of image.

Totally Made in Italy thanks to a proximity production, these handles are made of aluminum, a sustainable and recyclable material.

Aluminum is a responsible material, thanks to its ability to be endlessly reused with low energy consumption, making it essential for a more sustainable future.

The anodized finishes have a long-lasting resistance to weather conditions. The silver in the handle releases active ions that act against bacteria, giving rise to a natural and continuous antibacterial process.



Galactic Aluminium

Aluminium galattico

Handles

Maniglie

2

1



# 7900



MERCURY

SPACE

URANUS

JUPITER



MERCURY

	MERCURY	URANUS	JUPITER	SPACE	Conf. Pz.
1 Q8 RBQ 50x4 C/M Guarnitura Q8 ros./bocc. QUADRA patent con molla Lever handle 8mm on square rose key hole escutcheon springloaded	77900241833 32,48 ⚡	77900241834 32,48 ⚡	77900241841 32,48 ⚡	77900241876 32,48 ⚡	1
1 Q8 RBQY 50x4 C/M Guarnitura Q8 ros./bocc. QUADRA Yale con molla Lever handle 8mm on square rose cyl hole escutcheon springloaded	77900245833 32,48 ⚡	77900245834 32,48 ⚡	77900245841 32,48 ⚡	77900245876 32,48 ⚡	1
1 Q8 RBQWC Q6 50x4 C/M Guarnitura Q8 ros./bocc. QUADRA Wc Q6 con molla Lever handle 8mm on square rose wc hole escutcheon 6mm springloaded	77900248833 42,48 ⚡	77900248834 42,48 ⚡	77900248841 42,48 ⚡	77900248876 42,48 ⚡	1
2 DK40 BUS, 9,5 7900 GHTEK DK40 BUS. 9,5 window handle DK x 40mm with pins D.9,5	77900583033 15,25 ⚡	77900583034 15,25 ⚡	77900583041 15,25 ⚡	77900583076 15,25 ⚡	2
2 DK45 BUS, 9,5 c/viti 7900 GHTEK DK45 BUS. 9,5 c/viti window handle DK x 45mm with pins D.9,5 and screws	7790058333391 15,50 ⚡	7790058333491 15,50 ⚡	7790058334191 15,50 ⚡	7790058337691 15,50 ⚡	2

⚡ Servizio G48: Articolo a magazzino e disponibile entro 48 dall'elaborazione dell'ordine. In base a disponibilita' e condizioni di vendita.  
G48 service: Item in stock and available within 48 hours of order processing. Based on availability and sales conditions.

### PORTA

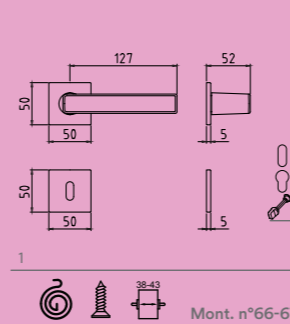

1  
Mont. n°66-67

### FINESTRA

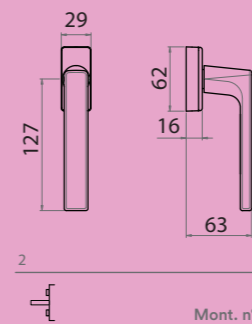

2  
Mont. n°14



Per istruzioni di montaggio  
scansiona QR code,  
seleziona il numero di  
riferimento e segui le  
istruzioni.  
For assembly instructions  
scan the QR code, select the  
relevant assembly number  
and follow the instructions.



MERCURY



SPACE



URANUS



JUPITER



URANUS

	MERCURY	URANUS	JUPITER	SPACE	Conf. Pz.
1 Q8 RBQ 50x4 C/M Guarnitura Q8 ros./bocc. QUADRA patent con molla Lever handle 8mm on square rose key hole escutcheon springloaded	70141241733	70141241734	70141241741	70141241776	1
1 Q8 RBQY 50x4 C/M Guarnitura Q8 ros./bocc. QUADRA Yale con molla Lever handle 8mm on square rose cyl hole escutcheon springloaded	70141245733	70141245734	70141245741	70141245776	1
1 Q8 RBQWC Q6 50x4 C/M Guarnitura Q8 ros./bocc. QUADRA Wc Q6 con molla Lever handle 8mm on square rose wc hole escutcheon 6mm springloaded	70141248733	70141248734	70141248741	70141248776	1
2 DK x 40 C/BUSS D.9,5 141 DKx40 C/BUSS D.9,5 window handle DK x 40 mm with pins D.9,5	7014155803395	7014155803495	7014155804195	7014155807695	2
2 DK x 45 C/BUSS D.9,5 C/viti 141 DKx45 C/BUSS D.9,5 C/viti window handle DK x 45 mm with pins D.9,5 with screws	7014155843395	7014155843495	7014155844195	7014155847695	2

⚡ Servizio G48: Articolo a magazzino e disponibile entro 48 dall'elaborazione dell'ordine. In base a disponibilit  e condizioni di vendita.  
G48 service: Item in stock and available within 48 hours of order processing. Based on availability and sales conditions.

## PORTA

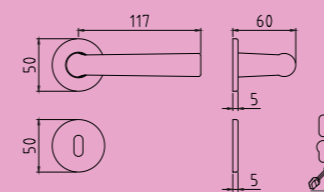

## FINESTRA

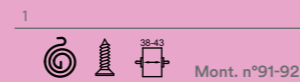
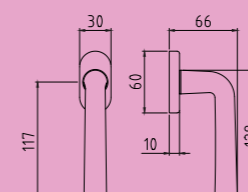

Per istruzioni di montaggio  
scansiona QR code,  
seleziona il numero di  
riferimento e segui le  
istruzioni.  
For assembly instructions  
scan the QR code, select the  
relevant assembly number  
and follow the instructions.

# Zama Zamak

38 Introduzione / Introduction  
40 Finiture / Finishes

42 CARTER  
44 CARTESIO  
46 CARTESIO B/W  
48 CARTESIO Q  
50 CARTESIO Q B/W  
52 CLIP  
54 FARFALLA  
56 FERGIE  
58 GALILEO  
60 GALILEO Q  
62 GM05  
64 GM07  
66 GM08  
68 GM10  
70 GM11  
72 IDEA  
74 IDEA Q  
76 LEAF  
78 LITZ  
80 MILENA Z  
82 NION  
84 NION Q  
86 R938  
88 RIALTO  
90 SEVEN  
92 SEVEN Q  
94 SHARK  
96 SWING  
98 TOY  
100 TOY Q  
102 UNO Z  
104 VICTORIA  
106 WING  
108 YORK  
110 YORK 4  
112 YORK BERRY  
114 YORK Q



Zama é una speciale lega di zinco, alluminio e magnesio particolarmente adatta per pressofusione con cui produciamo articoli che, dopo operazioni di finitura superficiale, vengono sottoposti a trattamenti galvanici di doratura, nichelatura, rodiatura, cromatura nonché all'esclusivo trattamento GHI.CO.TEC.

Zamak is a special alloy of zinc, aluminium and magnesium which is particularly suitable for die casting, used to produce articles which, after surface finishing operations, undergo galvanic treatments with gold, nickel, rhodium and chrome as well as our exclusive GHI.CO.TEC. treatment.

# Finiture Zama Zamak finishing

ZCL-BLACK	01	41
CHAMPAGNE	02	
TITANIUM	03	
ZCL	04	
LORENA	05	
ZCS	06	
COTOL	07	
ZNO-TITANIUM	08	
ZNS	09	
BORGOGNA	10	
ZCL-ZCS	11	
ZNO	12	
NORMANDIA	13	
ZGV	14	
Z-BGO	15	
Z-OSO	16	

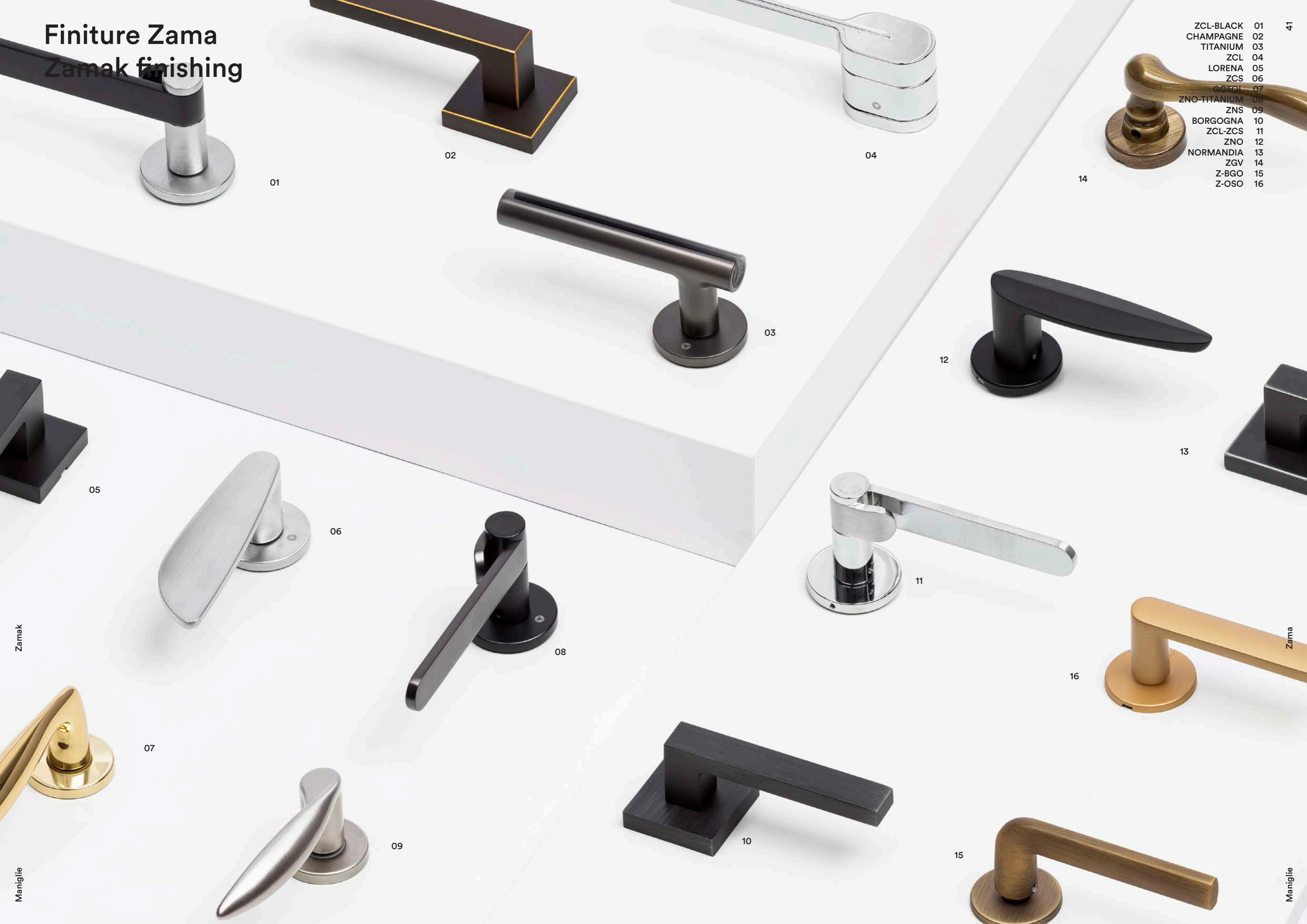

01

02

04

14

03

12

13

05

06

11

08

16

07

09

10

15

Zama

Maniglie

Zamak

Maniglie



ZCL



ZCS



ZNO



ZCS

	ZCL	ZCS	ZNO	Conf. Pz.
1 Q8 RQ Guarnitura Q8 ros. senza bocc. Lever handle 8mm on rose	66510240807 48,75	66510240813 40,75	66510240816 38,95	1
1 Q8 RBQ Guarnitura Q8 ros./bocc. patent Lever handle 8mm on rose key hole escutcheon	66510241807 60,71	66510241813 50,71 ⚡	66510241816 48,46 ⚡	1
1 Q8 RBQY Guarnitura Q8 ros./bocc. yale Lever handle 8mm on rose - cyl. hole escutcheon	66510245807 60,71	66510245813 50,71 ⚡	66510245816 48,46 ⚡	1
2 Q8 RBQWC Guarnitura Q8 ros./bocc. Wc Lever handle 8mm on rose wc hole escutcheon	66510248807 72,71	66510248813 60,71 ⚡	66510248816 58,01 ⚡	1
2 Q8 RBR Guarnitura Q8 ros./bocc. rett. patent molla dx/sx Lever handle 8mm on springloaded rect rose key hole esc	66510211407 84,73	66510211413 74,73	66510211416 72,48	1
2 Q8 RBRY Guarnitura Q8 ros./bocc. rett.yale molla dx/sx Lever handle 8mm on springloaded rect rose cylinder hole esc	66510215407 84,73	66510215413 74,73	66510215416 72,48	1
3 DK X 40 C/BUSS Martellina DK Q7 x 40 con bussole D. 9,5 gioco in ferro window handle DK x 40mm with pins D.9,5 iron mechanism	66510553807 43,50	66510553813 38,50	66510553816 37,37	2
4 DK X 40 ribassato Martellina DK Q7 x 40 ribassato window handle DK x 40 mm thin mechanism	66510594007 43,50	66510594013 38,50	66510594016 37,37	2

⚡ Servizio G48: Articolo a magazzino e disponibile entro 48 dall'elaborazione dell'ordine. In base a disponibilita' e condizioni di vendita.  
G48 service: Item in stock and available within 48 hours of order processing. Based on availability and sales conditions.

PORTA

FINESTRA

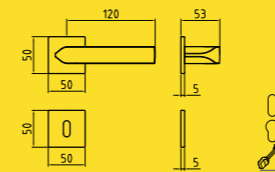

1 Ros 50x50x5  
(molla ambidestra - maniglia non solidale)  
Mont. n°66 - 67

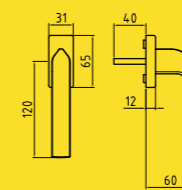

3 Gioco in ferro  
Mont. n°6

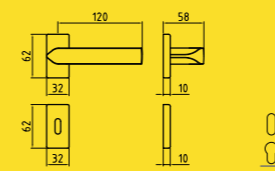

2 Ros 0006  
Mont. n°75

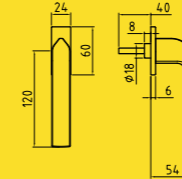

4  
Mont. n°7



Per istruzioni di montaggio scansiona QR code, seleziona il numero di riferimento e segui le istruzioni.  
For assembly instructions scan the QR code, select the relevant assembly number and follow the instructions.

# CARTESIO

DESIGN FABRIZIO BIANCHETTI



ZCL/F1-SAT



ZCL/F1-SAT

ZCL/F1-SAT

	ZCL-F1-SAT	Conf. Pz.
1 Q8 R Guarnitura Q8 ros. senza bocc. Lever handle 8mm on rose	55012280054 49,40	1
1 Q8 RB Guarnitura Q8 ros./bocc. patent Lever handle 8mm on rose key hole escutcheon	55012281054 57,44	1
1 Q8 RBY Guarnitura Q8 ros./bocc. yale Lever handle 8mm on rose - cyl. hole escutcheon	55012285054 57,44	1
1 Q8 RBWC Guarnitura Q8 ros./bocc. Wc Lever handle 8mm on rose wc hole escutcheon	55012288054 73,80	1
2 Q8 ROC Guarnitura Q8 ros.ovale senza bocc.molla dx/sx Lever handle 8mm on springloaded oval rose	55012220554 54,31	1
2 Q8 RBOC Guarnitura ros./bocc. ovale patent molla dx/sx Lever handle 8mm on springloaded oval rose key hole escutcheon	55012221554 63,24	1
2 Q8 RBOYC Guarnitura Q8 ros/boc. ovale yale molla dx/sx Lever handle 8mm on springloaded oval rose - cyl. hole escutcheon	55012225554 63,24	1
3 EZ IM Cremonese gioco EZ imp. maniglia Mechanism for window handle spindle 7 mm	55012456054 32,74	2
3 EZQ7 IM Cremonese gioco EZ + Q7 imp. maniglia Mechanism for window handle spindle 7 mm	55012457054 33,48	2
3 MART IM Martellina Q7 imp. Maniglia lever window handle	55012550054 32,74	2
4 DK X 40 Martellina DK Q7 x 40 window handle DK x 40 mm	55012557054 31,10	2
4 DK X 40 C/BUSS Martellina DK Q7 x 40 con bussole D. 9,5 window handle DK x 40mm with pins D.9,5	55012558054 31,10	2

PORTA

FINESTRA

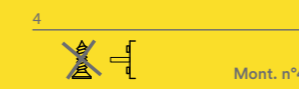
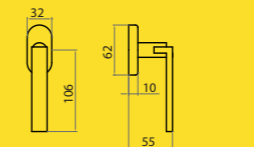
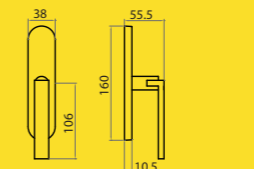
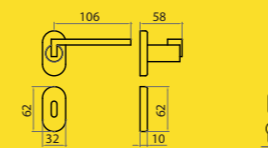
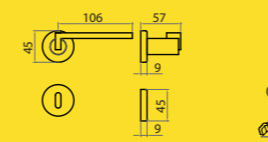

Per istruzioni di montaggio scansiona QR code, seleziona il numero di riferimento e segui le istruzioni.  
For assembly instructions scan the QR code, select the relevant assembly number and follow the instructions.

# CARTESIO B/W

DESIGN FABRIZIO BIANCHETTI



OCL/WHITE (RAL 9010 OPACO)



OCL/BLACK



OCL/WHITE (RAL 9010 OPACO)



OCL/BLACK



ZCL/F1-SAT

	ZCL-WHITE	ZCL-BLACK	Conf. Pz.
1 Q8 R Guarnitura Q8 ros. senza bocc. Lever handle 8mm on rose	55012280077 49,40	55012280086 49,40	1
1 Q8 RB Guarnitura Q8 ros./bocc. patent Lever handle 8mm on rose key hole escutcheon	55012281077 57,44	55012281086 57,44	1
1 Q8 RBY Guarnitura Q8 ros./bocc. yale Lever handle 8mm on rose - cyl. hole escutcheon	55012285077 57,44	55012285086 57,44	1
1 Q8 RBWC Guarnitura Q8 ros./bocc. Wc Lever handle 8mm on rose wc hole escutcheon	55012288077 73,80	55012288086 73,80	1
2 Q8 ROC Guarnitura Q8 ros.ovale senza bocc.molla dx/sx Lever handle 8mm on springloaded oval rose	55012220577 54,31	55012220586 54,31	1
2 Q8 RBOC Guarnitura ros./bocc. ovale patent molla dx/sx Lever handle 8mm on springloaded oval rose key hole escutcheon	55012221577 63,24	55012221586 63,24	1
2 Q8 RBOYC Guarnitura Q8 ros/boc. ovale yale molla dx/sx Lever handle 8mm on springloaded oval rose - cyl. hole escutcheon	55012225577 63,24	55012225586 63,24	1
3 EZ IM Cremonese gioco EZ imp. maniglia Mechanism for window handle spindle 7 mm	55012456077 32,74	55012456086 32,74	2
3 EZQ7 IM Cremonese gioco EZ + Q7 imp. maniglia Mechanism for window handle spindle 7 mm	55012457077 33,48	55012457086 33,48	2
3 MART IM Martellina Q7 imp. Maniglia lever window handle	55012550077 32,74	55012550086 32,74	2
4 DK X 40 Martellina DK Q7 x 40 window handle DK x 40 mm	55012557077 31,10	55012557086 31,10	2
4 DK X 40 C/BUSS Martellina DK Q7 x 40 con bussole D. 9,5 window handle DK x 40mm with pins D.9,5	55012558077 31,10	55012558086 31,10	2

PORTA

FINESTRA

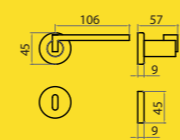

1 Ros 45x9

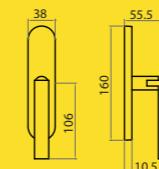
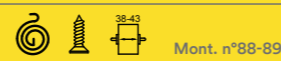

3

Mont. n°140-141

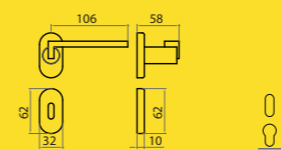

2 Ros 0006

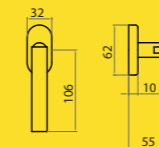

4

Mont. n°4



Per istruzioni di montaggio scansiona QR code, seleziona il numero di riferimento e segui le istruzioni.  
For assembly instructions scan the QR code, select the relevant assembly number and follow the instructions.



# CARTESIO Q

DESIGN FABRIZIO BIANCHETTI



ZCL/F1-SAT



ZCL/F1-SAT

	ZCL-F1-SAT	Conf. Pz.
1 Q8 RBQ Guarnitura Q8 ros./bocc. patent Lever handle 8mm on rose key hole escutcheon	44994281054 61,45	1
1 Q8 RBQY Guarnitura Q8 ros./bocc. yale Lever handle 8mm on rose - cyl. hole escutcheon	44994285054 61,45	1
1 Q8 RBQWC Guarnitura Q8 ros./bocc. Wc Lever handle 8mm on rose wc hole escutcheon	44994288054 77,67	1
2 Q8 RBR Guarnitura Q8 ros./bocc. rett. patent molla dx/sx Lever handle 8mm on springloaded rectangular rose key hole escutcheon	44994211454 67,70	1
2 Q8 RBYR Guarnitura Q8 ros./bocc. rett. yale molla dx/sx Lever handle 8mm on springloaded rectangular rose - cyl. hole escutcheon	44994215454 67,70	1
3 DK X 40 Martellina DK Q7 x 40 window handle DK x 40 mm	44994557054 31,10	2
3 DK X 40 C/BUSS Martellina DK Q7 x 40 con bussole D. 9,5 window handle DK x 40mm with pins D.9,5	44994558054 31,10	2

PORTA

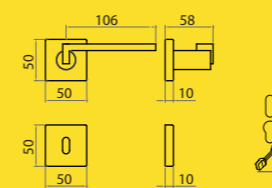

1 Ros 50x50x10 ALL  
Mont. n°57-58

FINESTRA

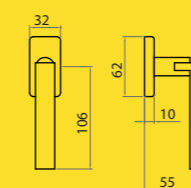

3 Mont. n°6

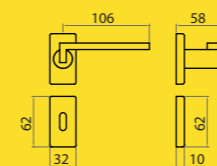

2 Mont. n°75



Per istruzioni di montaggio scansiona QR code, seleziona il numero di riferimento e segui le istruzioni.  
For assembly instructions scan the QR code, select the relevant assembly number and follow the instructions.

# CARTESIO Q B/W

DESIGN FABRIZIO BIANCHETTI

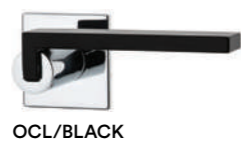

	ZCL-WHITE	ZCL-BLACK	Conf. Pz.
1 Q8 RBQ Guarnitura Q8 ros./bocc. patent Lever handle 8mm on rose key hole escutcheon	44994241677 67,61	44994241686 67,61	1
1 Q8 RBQY Guarnitura Q8 ros./bocc. yale Lever handle 8mm on rose - cyl. hole escutcheon	44994245677 67,61	44994245686 67,61	1
1 Q8 RBQWC Guarnitura Q8 ros./bocc. Wc Lever handle 8mm on rose wc hole escutcheon	44994248677 80,29	44994248686 80,29	1
2 Q8 RBR Guarnitura Q8 ros./bocc. rett. patent molla dx/sx Lever handle 8mm on springloaded rectangular rose key hole escutcheon	44994211477 67,70	44994211486 67,70	1
2 Q8 RBYR Guarnitura Q8 ros./bocc. rett. yale molla dx/sx Lever handle 8mm on springloaded rectangular rose - cyl. hole escutcheon	44994215477 67,70	44994215486 67,70	1
3 DK X 40 Martellina DK Q7 x 40 window handle DK x 40 mm	44994557077 31,10	44994557086 31,10	2
3 DK X 40 C/BUSS Martellina DK Q7 x 40 con bussole D. 9,5 window handle DK x 40mm with pins D.9,5	44994558077 31,10	44994558086 31,10	2

PORTA

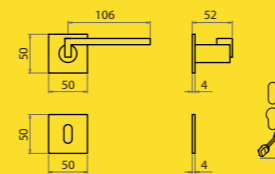

1 Ros 50x50x10 ALL  
Mont. n°66-67

FINESTRA

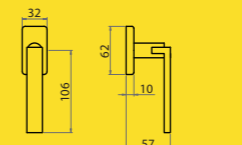

3 Mont. n°6

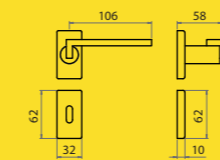

2 Mont. n°75



Per istruzioni di montaggio scansiona QR code, seleziona il numero di riferimento e segui le istruzioni.  
For assembly instructions scan the QR code, select the relevant assembly number and follow the instructions.

# CLIP

XXY DESIGN



	ZNO-TITANIUM	ZCS-BLACK	ZCL-ZCS	Conf. Pz.
1 Q8 R Guarnitura Q8 ros. senza bocc. Lever handle 8mm on rose	66530230518 61,34	66530230521 63,14	66530230559 71,14	1
1 Q8 RB Guarnitura Q8 ros./bocc. patent Lever handle 8mm on rose key hole escutcheon	66530231518 71,06	66530231521 73,31	66530231559 83,31	1
1 Q8 RBY Guarnitura Q8 ros./bocc. yale Lever handle 8mm on rose - cyl. hole escutcheon	66530235518 71,06	66530235521 73,31	66530235559 83,31	1
2 Q8 RBOC Guarnitura ros./bocc. ovale patent molla dx/sx Lever handle 8mm on springloaded oval rose key hole escutcheon	66530221518 77,27	66530221521 79,52	66530221559 89,52	1
2 Q8 RBOYC Guarnitura Q8 ros/boc. ovale yale molla dx/sx Lever handle 8mm on springloaded oval rose - cyl. hole escutcheon	66530225518 77,27	66530225521 79,52	66530225559 89,52	1
2 Q8 RBWC Guarnitura Q8 ros./bocc. Wc Lever handle 8mm on rose - wc 6mm function	66530238518 80,61	66530238521 83,31	66530238559 95,31	1
3 DK X 40 C/BUSS Martellina DK Q7 x 40 con bussole D. 9,5 gioco in ferro window handle DK x 40mm with pins D.9.5 iron mechanism	66530549518 42,59	66530549521 43,72	66530549559 48,72	2

PORTA

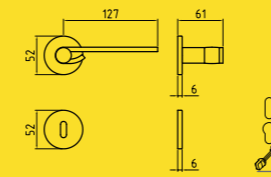

1 Ros 52x6  

 Mont. n°101-102

FINESTRA

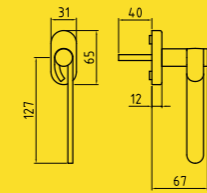

3 Gioco in ferro  

 Mont. n°2

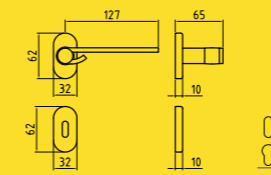

2 Ros 0006  

 Mont. n°21



Per istruzioni di montaggio  
scansiona QR code,  
seleziona il numero di  
riferimento e segui le  
istruzioni.  
For assembly instructions  
scan the QR code, select the  
relevant assembly number  
and follow the instructions.

# FARFALLA

DESIGN FRANCESCO LUCCHESI



ZCS

	ZCL	ZCS	ZNO	TITANIUM	Conf. Pz.
1 Q8 R Guarnitura Q8 ros. senza bocc. Lever handle 8mm on rose	66525230507 65,40	66525230513 57,40	66525230516 55,60	66525230554 65,40	1
1 Q8 RB Guarnitura Q8 ros./bocc. patent Lever handle 8mm on rose key hole escutcheon	66525231507 77,57	66525231513 67,57	66525231516 65,32	66525231554 77,57	1
1 Q8 RBY Guarnitura Q8 ros./bocc. yale Lever handle 8mm on rose - cyl. hole escutcheon	66525235507 77,57	66525235513 67,57	66525235516 65,32	66525235554 77,57	1
2 Q8 RBOC Guarnitura ros./bocc. ovale patent molla dx/sx Lever handle 8mm on springloaded oval rose key hole escutcheon	66525221507 83,78	66525221513 73,78	66525221516 71,53	66525221554 83,78	1
2 Q8 RBOYC Guarnitura Q8 ros/boc. ovale yale molla dx/sx Lever handle 8mm on springloaded oval rose - cyl. hole escutcheon	66525225507 83,78	66525225513 73,78	66525225516 71,53	66525225554 83,78	1
2 Q8 RBWC Guarnitura Q8 ros./bocc. Wc Lever handle 8mm on rose - wc 6mm function	66525238507 89,57	66525238513 77,57	66525238516 74,87	66525238554 89,57	1
3 DK X 40 C/BUSS Martellina DK Q7 x 40 con bussole D. 9,5 gioco in ferro window handle DK x 40mm with pins D.9,5 iron mechanism	66525549507 45,30	66525549513 40,30	66525549516 39,17	66525549554 45,30	2

PORTA

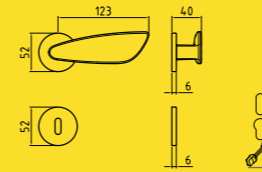

1 Ros 52x6  
Mont. n°99-100

FINESTRA

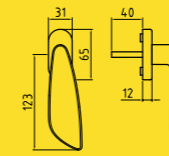

3 Gioco in ferro  
Mont. n°1

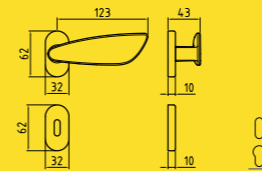

2 Ros 0006  
Mont. n°20



Per istruzioni di montaggio  
scansiona QR code,  
seleziona il numero di  
riferimento e segui le  
istruzioni.  
For assembly instructions  
scan the QR code, select the  
relevant assembly number  
and follow the instructions.

# FERGIE

DESIGN XXY DESIGN



ZCS

66535

Fergie

Zamak

Handles

	ZCL	ZCS	ZNO	TITANIUM	Conf. Pz.
1 Q8 R Guarnitura Q8 ros. senza bocc. Lever handle 8mm on rose	66355230507 66,36	66355230513 58,36	66355230516 56,56	66355230554 66,36	1
1 Q8 RB Guarnitura Q8 ros./bocc. patent Lever handle 8mm on rose key hole escutcheon	66535231507 78,53	66535231513 68,53	66535231516 66,28	66535231554 78,53	1
1 Q8 RBY Guarnitura Q8 ros./bocc. yale Lever handle 8mm on rose - cyl. hole escutcheon	66535235507 78,53	66535235513 68,53	66535235516 66,28	66535235554 78,53	1
2 Q8 RBOC Guarnitura ros./bocc. ovale patent molla dx/sx Lever handle 8mm on springloaded oval rose key hole escutcheon	66535221507 84,74	66535221513 74,74	66535221516 72,49	66535221554 84,74	1
2 Q8 RBOYC Guarnitura Q8 ros/boc. ovale yale molla dx/sx Lever handle 8mm on springloaded oval rose - cyl. hole escutcheon	66535225507 84,74	66535225513 74,74	66535225516 72,49	66535225554 84,74	1
2 Q8 RBWC Guarnitura Q8 ros./bocc. Wc Lever handle 8mm on rose - wc 6mm function	66535238507 90,53	66535238513 78,53	66535238516 75,83	66535238554 90,53	1
3 DK X 40 C/BUSS Martellina DK Q7 x 40 con bussole D. 9,5 gioco in ferro window handle DK x 40mm with pins D.9,5 iron mechanism	66535549507 45,87	66535549513 40,87	66535549516 39,74	66535549554 45,87	2

PORTA

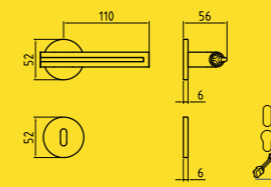

1 Ros 52x6  
Mont. n°103-104

FINESTRA

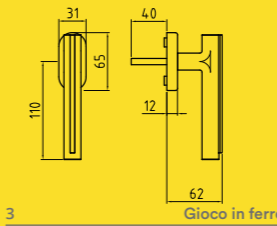

3 Gioco in ferro  
Mont. n°3

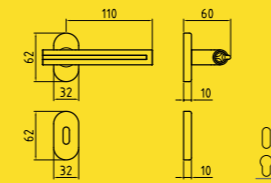

2 Ros 0006  
Mont. n°22



Per istruzioni di montaggio scansiona QR code, seleziona il numero di riferimento e segui le istruzioni.  
For assembly instructions scan the QR code, select the relevant assembly number and follow the instructions.

66535

Fergie

Zama

Maniglie

# GALILEO



ZCL/F1-SAT



ZCL/F1-SAT



ZCL/F1-SAT

	ZCL-F1-SAT	Conf. Pz.
1 Q8 R Guarnitura Q8 ros. senza bocc. Lever handle 8mm on rose	55112280054 49,40	1
1 Q8 RB Guarnitura Q8 ros./bocc. patent Lever handle 8mm on rose key hole escutcheon	55112281054 57,44	1
1 Q8 RBY Guarnitura Q8 ros./bocc. yale Lever handle 8mm on rose - cyl. hole escutcheon	55112285054 57,44	1
1 Q8 RBWC Guarnitura Q8 ros./bocc. Wc Lever handle 8mm on rose wc hole escutcheon	55112288054 73,80	1
2 Q8 ROC Guarnitura Q8 ros.ovale senza bocc.molla dx/sx Lever handle 8mm on springloaded oval rose	55112220554 54,31	1
2 Q8 RBOC Guarnitura ros./bocc. ovale patent molla dx/sx Lever handle 8mm on springloaded oval rose key hole escutcheon	55112221554 63,24	1
2 Q8 RBOYC Guarnitura Q8 ros/boc. ovale yale molla dx/sx Lever handle 8mm on springloaded oval rose - cyl. hole escutcheon	55112225554 63,24	1
3 EZ IM Cremonese gioco EZ imp. maniglia Mechanism for window handle spindle 7 mm	55112456054 32,74	2
3 EZQ7 IM Cremonese gioco EZ + Q7 imp. maniglia Mechanism for window handle spindle 7 mm	55112457054 33,48	2
3 MART IM Martellina Q7 imp. Maniglia lever window handle	55112550054 32,74	2
4 DK X 40 Martellina DK Q7 x 40 window handle DK x 40 mm	55112557054 31,10	2
4 DK X 40 C/BUSS Martellina DK Q7 x 40 con bussole D. 9,5 window handle DK x 40mm with pins D.9,5	55112558054 31,10	2

## PORTA

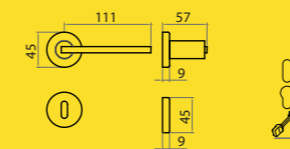

1 Ros 45x9



Mont. n°88-89

## FINESTRA

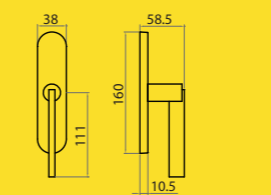

3

Mont. n°140-141

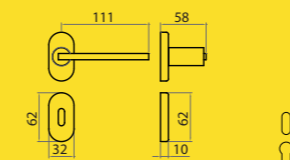

2 Ros 0006



Mont. n°25

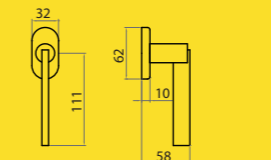

4



Mont. n°4



Per istruzioni di montaggio  
scansiona QR code,  
seleziona il numero di  
riferimento e segui le  
istruzioni.  
For assembly instructions  
scan the QR code, select the  
relevant assembly number  
and follow the instructions.

# GALILEO Q

DESIGN UFFICIO ESPERIENZE GHIDINI



ZCL/F1-SAT



ZCL/F1-SAT

44996

Galileo Q

Zamak

Handles

	ZCL-F1-SAT	Conf. Pz.
1 Q8 RBQ Guarnitura Q8 ros./bocc. patent Lever handle 8mm on rose key hole escutcheon	44996281054 61,45	1
1 Q8 RBQY Guarnitura Q8 ros./bocc. yale Lever handle 8mm on rose - cyl. hole escutcheon	44996285054 61,45	1
1 Q8 RBQWC Guarnitura Q8 ros./bocc. Wc Lever handle 8mm on rose wc hole escutcheon	44996288054 77,67	1
2 Q8 RBR Guarnitura Q8 ros./bocc. rett. patent molla dx/sx Lever handle 8mm on springloaded rect rose key hole esc	44996211454 73,85	1
2 Q8 RBYR Guarnitura Q8 ros./bocc. rett. yale molla dx/sx Lever handle 8mm on springloaded rect rose - cyl. hole esc	44996215454 73,85	1
3 DK X 40 Martellina DK Q7 x 40 window handle DK x 40 mm	44996557054 31,10	2
3 DK X 40 C/BUSS Martellina DK Q7 x 40 con bussole D. 9,5 window handle DK x 40mm with pins D.9,5	44996558054 31,10	2

44996

Galileo Q

Zama

Maniglie

## PORTA

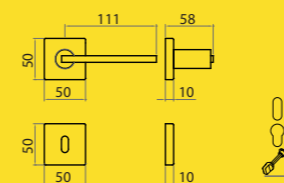

1 Ros 50x50x10 ALL  
Mont. n°57-58

## FINESTRA

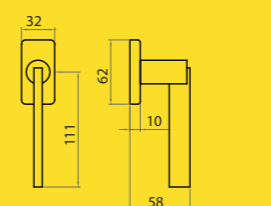

3  
Mont. n°6

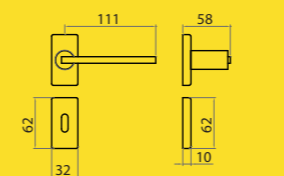

2  
Mont. n°75



Per istruzioni di montaggio  
scansiona QR code,  
seleziona il numero di  
riferimento e segui le  
istruzioni.  
For assembly instructions  
scan the QR code, select the  
relevant assembly number  
and follow the instructions.

# GM05



ZCS                      ZGV                      ZCL



ZOS                      GCTOL

	ZCS	ZCS/F1-SAT	ZCS/F1-SAT/GSH	GCTOL	GCTOL/GSH	ZCL	ZGV	Conf. Pz.
1 Q8 R Guarnitura Q8 ros. senza bocc. Lever handle 8mm on rose	6GM59280013	14,57		6GM58280012	22,10	6GM58280007	6GM58280004	1
1 Q8 RB Guarnitura Q8 ros./bocc. patent Lever handle 8mm on rose key hole escutcheon	6GM59281013	16,29 ⚡	6GM59281013S	6GM58281012	24,00 ⚡	6GM58281012S	17,09	6GM58281007
1 Q8 RBY Guarnitura Q8 ros./bocc. yale Lever handle 8mm on rose - cyl. hole escutcheon	6GM59285013	16,29 ⚡	6GM59285013S	6GM58285012	24,00 ⚡	6GM58285012S	17,09	6GM58285007
1 Q8 RBWC Guarnitura Q8 ros./bocc. Wc Lever handle 8mm on rose wc hole escutcheon	6GM59288013	27,71 ⚡		6GM58288012	37,42 ⚡	6GM58288007	6GM58288004	1
2 Q8 ROC Guarnitura Q8 ros.ovale senza bocc. Lever handle 8mm on oval rose	6GM58220513	35,69		6GM58220512	37,69	6GM58220507	6GM58220504	1
2 Q8 RBOC Guarnitura Q8 ros/boc. ovale patent Lever handle 8mm on oval rose key hole escutcheon	6GM58221513	45,76		6GM58221512	48,26	6GM58221507	6GM58221504	1
2 Q8 RBOYC Guarnitura Q8 ros/boc. ovale Yale Lever handle 8mm on oval rose - cyl. hole escutcheon	6GM58225513	45,76		6GM58225512	48,26	6GM58225507	6GM58225504	1
3 DK X 40 Martellina DK Q7 x 40 window handle DK x 40 mm	6GM58557013	13,08		6GM58557012	14,33	6GM58557007	6GM58557004	2
3 DK X 40 C/BUSS. Martellina DK Q7 x 40 con bussola D. 9,5 window handle DK x 40mm with pins D.9,5	6GM58558013	9,50		6GM58558012	10,75	6GM58558007	6GM58558004	2

⚡ Servizio G48: Articolo a magazzino e disponibile entro 48 dall'elaborazione dell'ordine. In base a disponibilita' e condizioni di vendita.  
G48 service: Item in stock and available within 48 hours of order processing. Based on availability and sales conditions.

PORTA

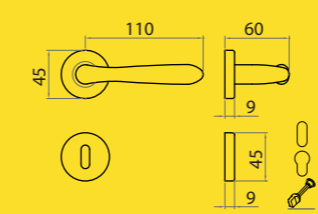

1 Ros 45x9  
Mont. n°88-89

FINESTRA

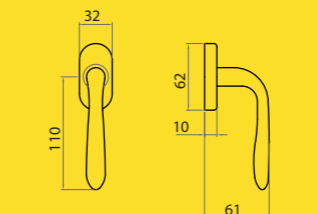

3  
Mont. n°8

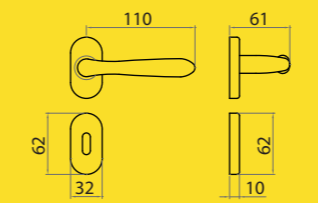

2  
Mont. n°25



Per istruzioni di montaggio scansiona QR code, seleziona il numero di riferimento e segui le istruzioni.  
For assembly instructions scan the QR code, select the relevant assembly number and follow the instructions.



# GM07



	ZCL	ZCS	Conf. Pz.
1 Q8 RQ Guarnitura Q8 ros. senza bocc. Lever handle 8mm on rose	6GM07240507	6GM07240513	1
1 Q8 RBQ Guarnitura Q8 ros./bocc. patent Lever handle 8mm on rose key hole escutcheon	6GM07241507	6GM07241513	1
1 Q8 RBQY Guarnitura Q8 ros./bocc. yale Lever handle 8mm on rose - cyl. hole escutcheon	6GM07245507	6GM07245513	1
1 Q8 RBQWC Guarnitura Q8 ros./bocc. Wc Lever handle 8mm on rose wc hole escutcheon	6GM07248007	6GM07248013	1
2 Q8 RRC Guarnitura Q8 ros. senza bocc. con molla Lever handle 8mm on springloaded rectangular rose	6GM07210407	6GM07210413	1
2 Q8 RBR Guarnitura Q8 ros./bocc. patent con molla Lever handle 8mm on springloaded rect rose key hole esc	6GM07211407	6GM07211413	1
2 Q8 RBYR Guarnitura Q8 ros./bocc. rett.yale molla dx/sx Lever handle 8mm on springloaded rect rose - cyl. hole esc	6GM07215407	6GM07215413	1
3 DK x 40 Martellina DK Q7 x 40 window handle DK x 40 mm	6GM07555007	6GM07555013	2
3 DK X 40 C/BUS Martellina DK Q7 x 40 con bussole D. 9,5 window handle DK x 40mm with pins D.9,5	6GM07556007	6GM07556013	2

## PORTA

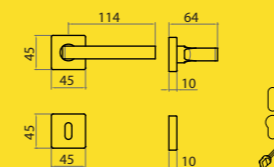

1 Ros 45x45



## FINESTRA

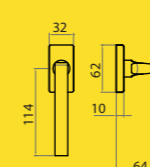

3

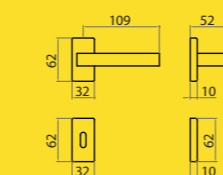

2



Per istruzioni di montaggio  
scansiona QR code,  
seleziona il numero di  
riferimento e segui le  
istruzioni.  
For assembly instructions  
scan the QR code, select the  
relevant assembly number  
and follow the instructions.

# GM08



	ZCS	ZCS/F1-SAT	ZCS/GSH	ZCL	Conf. Pz.
1 Q8 RQ Guarnitura Q8 ros. senza bocc. Lever handle 8mm on rose		6GM08240313		6GM08240007	1
1 Q8 RBQ Guarnitura Q8 ros./bocc. patent Lever handle 8mm on rose key hole escutcheon		6GM08241313	6GM08241013S	6GM08241007	1
1 Q8 RBQY Guarnitura Q8 ros./bocc. yale Lever handle 8mm on rose - cyl. hole escutcheon		6GM08245313	6GM08245013S	6GM08245007	1
1 Q8 RBQWC Guarnitura Q8 ros./bocc. Wc Lever handle 8mm on rose wc hole escutcheon		6GM08248313	6GM08248013S	6GM08248007	1
2 Q8 RRC guarnitura rosetta rettangolare Q8 C/M molla dx/sx Lever handle 8mm on springloaded rectangular rose	6GM08210413			6GM08210407	1
2 Q8 RBR Guarnitura Q8 ros./bocc. rett. patent molla dx/sx Lever handle 8mm on springloaded rect rose key hole esc	6GM08211413			6GM08211407	1
2 Q8 RBYR Guarnitura Q8 ros./bocc. rett.yale molla dx/sx Lever handle 8mm on springloaded rect rose - cyl. hole esc	6GM08215413			6GM08215407	1
3 DK X 40 Martellina DK Q7 x 40 window handle DK x 40 mm	6GM08555013			6GM08555007	2
3 DK X 40 C/BUSS. Martellina DK Q7 x 40 con bussole D. 9,5 window handle DK x 40mm with pins D.9,5	6GM08556013			6GM08556007	2

⚡ Servizio G48: Articolo a magazzino e disponibile entro 48 dall'elaborazione dell'ordine. In base a disponibilita' e condizioni di vendita.  
G48 service: Item in stock and available within 48 hours of order processing. Based on availability and sales conditions.

## PORTA

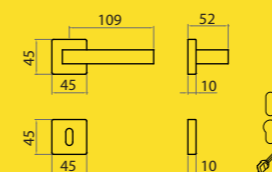

1 Ros 45x45



## FINESTRA

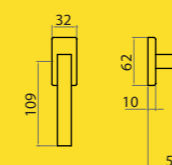

3

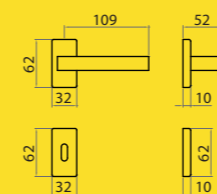

2



Per istruzioni di montaggio  
scansiona QR code,  
seleziona il numero di  
riferimento e segui le  
istruzioni.  
For assembly instructions  
scan the QR code, select the  
relevant assembly number  
and follow the instructions.

# GM10



ZCS

ZCL

ZCS

ZNO

	ZCL	ZCS	ZNO	Conf. Pz.
1 Q8 RQ Guarnitura Q8 ros. senza bocc. Lever handle 8mm on rose	6GM10240607 55,48	6GM10240613 47,48	6GM10240616 45,68	1
1 Q8 RBQ Guarnitura Q8 ros./bocc. patent Lever handle 8mm on rose key hole escutcheon	6GM10241607 67,96	6GM10241613 57,96	6GM10241616 55,71	1
1 Q8 RBQY Guarnitura Q8 ros./bocc. yale Lever handle 8mm on rose - cyl. hole escutcheon	6GM10245607 67,96	6GM10245613 57,96	6GM10245616 55,71	1
2 Q8 RRC guarnitura rosetta rettangolare Q8 C/M molla dx/sx Lever handle 8mm on springloaded rectangular rose	6GM10210407 63,01	6GM10210413 55,01	6GM10210416 53,21	1
2 Q8 RBR Guarnitura Q8 ros./bocc. rett. patent molla dx/sx Lever handle 8mm on springloaded rect rose key hole esc	6GM10211407 75,55	6GM10211413 65,55	6GM10211416 63,30	1
2 Q8 RBYR Guarnitura Q8 ros./bocc. rett.yale molla dx/sx Lever handle 8mm on springloaded rect rose - cyl. hole esc	6GM10215407 75,55	6GM10215413 65,55	6GM10215416 63,30	1
2 Q8 RBQWC Guarnitura Q8 ros./bocc. Wc Lever handle 8mm on rose wc hole escutcheon	6GM10248607 79,96	6GM10248613 67,96	6GM10248616 65,26	1
3 DK X 40 Martellina DK Q7 x 40 window handle DK x 40 mm	6GM10555007 28,89	6GM10555013 23,89	6GM10555016 22,76	2
3 DK X 40 C/BUSS. Martellina DK Q7 x 40 con bussole D. 9,5 window handle DK x 40mm with pins D.9,5	6GM10556007 28,89	6GM10556013 23,89	6GM10556016 22,76	2

## PORTA

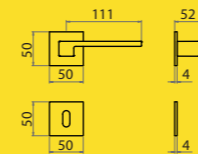

1 Ros 50x50x4



Mont. n°66-67

## FINESTRA

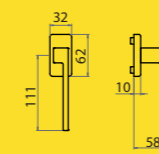

3



Mont. n°6

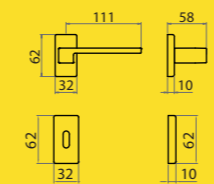

2 0006



Mont. n°75



Per istruzioni di montaggio  
scansiona QR code,  
seleziona il numero di  
riferimento e segui le  
istruzioni.  
For assembly instructions  
scan the QR code, select the  
relevant assembly number  
and follow the instructions.

# GM11



ZCL



ZCS

	ZCS	ZCS-MET	ZCS-GSH	ZCL	ZNO	Conf. Pz.
1 Q8 RQ Guarnitura Q8 ros. senza bocc. Lever handle 8mm on rose		6GM11240313 27,97		6GM11240507 35,97	6GM11240516 26,17	1
1 Q8 RBQ Guarnitura Q8 ros./bocc. patent Lever handle 8mm on rose key hole escutcheon		6GM11241313 31,13 ⚡	6GM11241513S 21,89	6GM11241507 41,13	6GM11241516 28,88	1
1 Q8 RBQY Guarnitura Q8 ros./bocc. yale Lever handle 8mm on rose - cyl. hole escutcheon		6GM11245313 31,13 ⚡	6GM11245513S 21,89	6GM11245507 41,13	6GM11245516 28,88	1
1 Q8 RBQWC Guarnitura Q8 ros./bocc. Wc Lever handle 8mm on rose wc hole escutcheon		6GM11248313 41,13 ⚡	6GM11248013S 33,31	6GM11248007 53,13		1
2 Q8 RBR Guarnitura Q8 ros./bocc. rett. patent molla dx/sx Lever handle 8mm on springloaded rect rose key hole esc		6GM11211413 48,48		6GM11211407 58,48		1
2 Q8 RBYR Guarnitura Q8 ros./bocc. rett.yale molla dx/sx Lever handle 8mm on springloaded rect rose - cyl. hole esc		6GM11215413 48,48		6GM11215407 58,48		1
3 DK X 40 C/BUSS. Martellina DK Q7 x 40 con bussole D. 9,5 window handle DK x 40mm with pins D.9,5		6GM11553813 15,28		6GM11553807 20,28		2

⚡ Servizio G48: Articolo a magazzino e disponibile entro 48 dall'elaborazione dell'ordine. In base a disponibilita' e condizioni di vendita.  
G48 service: Item in stock and available within 48 hours of order processing. Based on availability and sales conditions.

## PORTA

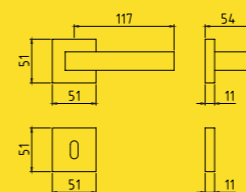

1 Ros 50x50x11

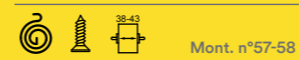

Mont. n°57-58

## FINESTRA

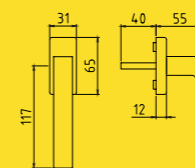

3 Gioco in ferro

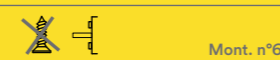

Mont. n°6

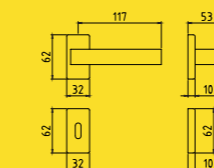

2 0006

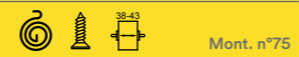

Mont. n°75



Per istruzioni di montaggio  
scansiona QR code,  
seleziona il numero di  
riferimento e segui le  
istruzioni.  
For assembly instructions  
scan the QR code, select the  
relevant assembly number  
and follow the instructions.



ZCL

ZNS



ZCS



ZCL

	ZCL	ZCS	ZNS	Conf. Pz.
1 Q8 R Guarnitura Q8 ros. senza bocc. Lever handle 8mm on rose	66092280507 31,21	66092280513 23,21	66092280527 39,21	1
1 Q8 RB Guarnitura Q8 ros./bocc. patent Lever handle 8mm on rose key hole escutcheon	66092281507 39,46	66092281513 29,46	66092281527 49,46	1
1 Q8 RBY Guarnitura Q8 ros./bocc. yale Lever handle 8mm on rose - cyl. hole escutcheon	66092285507 39,46	66092285513 29,46	66092285527 49,46	1
1 Q8 RBWC Guarnitura Q8 ros./bocc. Wc Lever handle 8mm on rose wc hole escutcheon	66092288007 51,46	66092288013 39,46	66092288027 63,46	1
2 Q8 ROC Guarnitura Q8 ros.ovale senza bocc. Lever handle 8mm on oval rose	66092220507 33,59	66092220513 25,59	66092220527 41,59	1
2 Q8 RBOC Guarnitura Q8 ros/boc. ovale patent Lever handle 8mm on oval rose key hole escutcheon	66092221507 42,44	66092221513 32,44	66092221527 52,44	1
2 Q8 RBOYC Guarnitura Q8 ros/boc. ovale Yale Lever handle 8mm on oval rose - cyl. hole escutcheon	66092225507 42,44	66092225513 32,44	66092225527 52,44	1
3 EZ Cremonese gioco EZ Mechanism for window handle spindle 7 mm	66094406007 33,00	66094406013 25,00	66094406027 43,00	2
3 EZQ7 Cremonese gioco EZ + Q7 Mechanism for window handle spindle 7 mm	66094407007 33,59	66094407013 25,59	66094407027 41,59	2
3 MART Martellina Q7 window handle	66094500007 33,00	66094500013 25,00	66094500027 43,00	2
4 DK x 40-35 Martellina DK Q7 x 40-35 window handle DK x 40-35mm	66092577007 18,84	66092577013 13,84	66092577027 23,84	2
4 DK x 40-35 C/BUSS Martellina DK Q7 x 40-35 con bussole window handle DK x 40-35 mm with pins D.9,5	66092578007 18,84	66092578013 13,84	66092578027 23,84	2

## PORTA

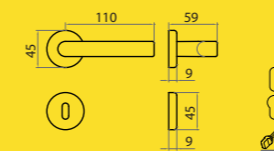

1 Ros 45x9



## FINESTRA

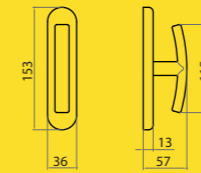

3

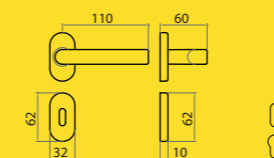

2 Ros 0006

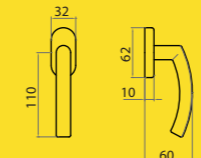

4



Per istruzioni di montaggio  
scansiona QR code,  
seleziona il numero di  
riferimento e segui le  
istruzioni.  
For assembly instructions  
scan the QR code, select the  
relevant assembly number  
and follow the instructions.

# IDEA Q

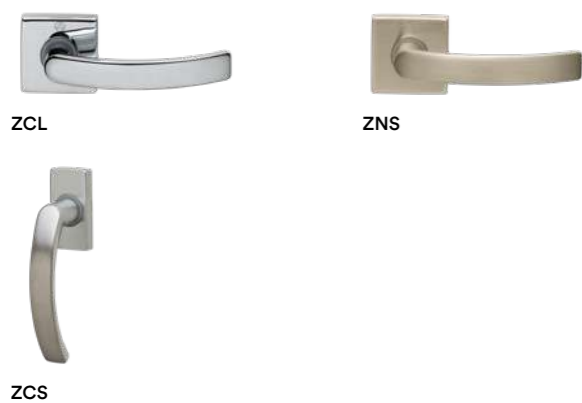

66080

Idea Q

Zamak

Handles

	ZCL	ZCS	ZNS	Conf. Pz.
1 Q8 RQ Guarnitura Q8 ros. senza bocc. Lever handle 8mm on rose	66080280507 34,64	66080280513 26,64	66080280527 42,64	1
1 Q8 RBQ Guarnitura Q8 ros./bocc. patent Lever handle 8mm on rose key hole escutcheon	66080281507 48,39	66080281513 38,39	66080281527 58,39	1
1 Q8 RBQY Guarnitura Q8 ros./bocc. yale Lever handle 8mm on rose - cyl. hole escutcheon	66080285507 48,39	66080285513 38,39	66080285527 58,39	1
1 Q8 RBQWC Guarnitura Q8 ros./bocc. Wc Lever handle 8mm on rose wc hole escutcheon	66080288007 60,39	66080288013 48,39	66080288027 72,39	1
2 Q8 RRC guarnitura rosetta rettangolare Q8 C/M molla dx/sx Lever handle 8mm on springloaded rectangular rose	66080210407 40,84	66080210413 32,84	66080210427 48,84	1
2 Q8 RBR Guarnitura Q8 ros./bocc. rett. patent molla dx/sx Lever handle 8mm on springloaded rect rose key hole esc	66080211407 60,79	66080211413 50,79	66080211427 70,79	1
2 Q8 RBYR Guarnitura Q8 ros./bocc. rett.yale molla dx/sx Lever handle 8mm on springloaded rect rose - cyl. hole esc	66080215407 60,79	66080215413 50,79	66080215427 70,79	1
3 DK x 40-35 Martellina DK Q7 x 40-35 window handle DK x 40-35mm	66080577007 19,88	66080577013 14,88	66080577027 24,88	2
3 DK x 40-35 C/BUSS Martellina DK Q7 x 40-35 con bussole window handle DK x 40-35 mm with pins D.9,5	66080578007 19,88	66080578013 14,88	66080578027 24,88	2

66080

Idea Q

Zama

Maniglie

PORTA

FINESTRA

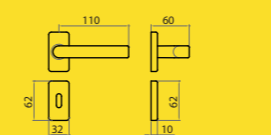
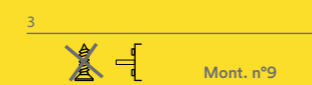
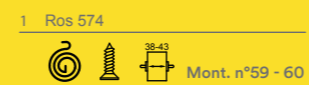
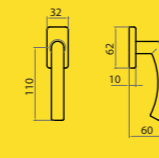
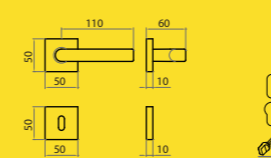

Per istruzioni di montaggio  
scansiona QR code,  
seleziona il numero di  
riferimento e segui le  
istruzioni.  
For assembly instructions  
scan the QR code, select the  
relevant assembly number  
and follow the instructions.

# LEAF

DESIGN MESSINEO E SETTIMELLI



ZCL



ZCS



ZNO



ZCS

	ZCL	ZCS	ZNO	Conf. Pz.
1 Q8 R Guarnitura Q8 ros. senza bocch. Lever handle 8mm on rose	66505240707 57,06	66505240713 49,06	66505240716 47,26	1
1 Q8 RB Guarnitura Q8 ros./bocch. patent Lever handle 8mm on rose key hole escutcheon	66505241707 67,96 ⚡	66505241713 57,96	66505241716 55,71 ⚡	1
1 Q8 RBY Guarnitura Q8 ros./bocch. yale Lever handle 8mm on rose - cyl. hole escutcheon	66505245707 67,96 ⚡	66505245713 57,96	66505245716 55,71 ⚡	1
1 Q8 RBWC Guarnitura Q8 ros./bocch. Wc Lever handle 8mm on rose - wc 6mm function	66505248707 79,96 ⚡	66505248713 67,96	66505248716 65,26 ⚡	1
2 Q8 RBOC Guarnitura ros./bocch. ovale patent molla dx/sx Lever handle 8mm on springloaded oval rose key hole escutcheon	66505221507 78,13	66505221513 68,13	66505221516 65,88	1
2 Q8 RBOYC Guarnitura Q8 ros/boc. ovale yale molla dx/sx Lever handle 8mm on springloaded oval rose - cyl. hole escutcheon	66505225507 78,13	66505225513 68,13	66505225516 65,88	1
3 DK X 40 C/BUSS Martellina DK Q7 x 40 con bussole D. 9,5 gioco in ferro window handle DK x 40mm with pins D.9,5 iron mechanism	66505549507 38,83	66505549513 33,83	66505549516 32,70	2
4 DK X 40 ribassato Martellina DK Q7 x 40 ribassato window handle DK x 40 mm thin mechanism	66505596007 38,83	66505596013 33,83	66505596016 32,70	2

⚡ Servizio G48: Articolo a magazzino e disponibile entro 48 dall'elaborazione dell'ordine. In base a disponibilita' e condizioni di vendita.  
G48 service: Item in stock and available within 48 hours of order processing. Based on availability and sales conditions.

PORTA

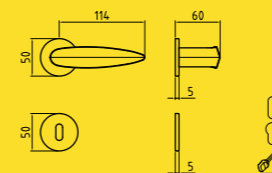

1 Ros ribassata (molla dx e sx - maniglia non solidale)



Mont. n°91-92

FINESTRA

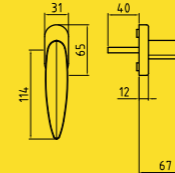

3 Gioco in ferro

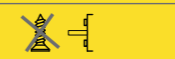

Mont. n°4

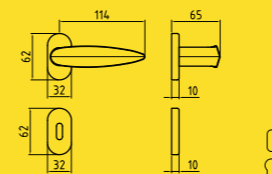

2 Ros 0006



Mont. n°23

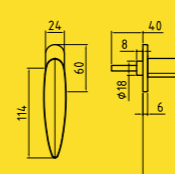

4



Mont. n°5



Per istruzioni di montaggio scansiona QR code, seleziona il numero di riferimento e segui le istruzioni.  
For assembly instructions scan the QR code, select the relevant assembly number and follow the instructions.



ZCL

ZCS

ZNO

ZCS

	ZCL	ZCS	ZNO	Conf. Pz.
1 Q8 R Guarnitura Q8 ros. senza bocc. Lever handle 8mm on rose	66500240707 41,76	66500240713 33,76	66500240716 31,96	1
1 Q8 RB Guarnitura Q8 ros./bocc. patent Lever handle 8mm on rose key hole escutcheon	66500241707 50,94	66500241713 40,94 ⚡	66500241716 38,69 ⚡	1
1 Q8 RBY Guarnitura Q8 ros./bocc. yale Lever handle 8mm on rose - cyl. hole escutcheon	66500245707 50,94	66500245713 40,94 ⚡	66500245716 38,69 ⚡	1
1 Q8 RBWC Guarnitura Q8 ros./bocc. Wc Lever handle 8mm on rose - wc 6mm function	66500248707 62,94	66500248713 50,94 ⚡	66500248716 48,24 ⚡	1
2 Q8 RBOC Guarnitura ros./bocc. ovale patent molla dx/sx Lever handle 8mm on springloaded oval rose key hole escutcheon	66500221507 74,01	66500221513 64,01	66500221516 61,76	1
2 Q8 RBOYC Guarnitura Q8 ros./boc. ovale yale molla dx/sx Lever handle 8mm on springloaded oval rose - cyl. hole escutcheon	66500225507 74,01	66500225513 64,01	66500225516 61,76	1
3 DK X 40 C/BUSS Martellina DK Q7 x 40 con bussole D. 9,5 gioco in ferro window handle DK x 40mm with pins D.9,5 iron mechanism	66500549507 37,10	66500549513 32,10	66500549516 30,97	2
4 DK X 40 ribassato Martellina DK Q7 x 40 ribassato window handle DK x 40 mm thin mechanism	66500596007 37,10	66500596013 32,10	66500596016 30,97	2

⚡ Servizio G48: Articolo a magazzino e disponibile entro 48 dall'elaborazione dell'ordine. In base a disponibilita' e condizioni di vendita.  
G48 service: Item in stock and available within 48 hours of order processing. Based on availability and sales conditions.

PORTA

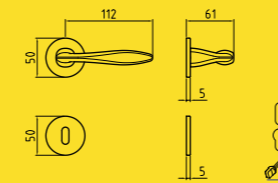

1 Ros ribassata (molla dx e sx - maniglia non solidale)  
Mont. n°91-92

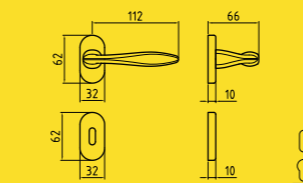

2 Ros 0006 Mont. n°23

FINESTRA

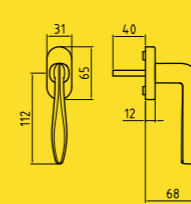

3 Gioco in ferro

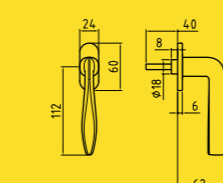

4 Mont. n°5



Per istruzioni di montaggio scansiona QR code, seleziona il numero di riferimento e segui le istruzioni.  
For assembly instructions scan the QR code, select the relevant assembly number and follow the instructions.



# MILENA Z



	ZCS	ZCS/F1-SAT	GCTOL	ZCL	Conf. Pz.
1 Q8 P90 Guarnitura Q8 placca patent 90 Lever handle 8mm on key plate 90	66744089013 45,28		66744089012 49,03	66744089007 60,28	1
1 Q8 P70 Guarnitura Q8 placca patent 70 Lever handle 8mm on key plate 70	66744087013 45,28		66744087012 49,03	66744087007 60,28	1
1 Q8 PY85 Guarnitura Q8 placca yale 85 Lever handle 8mm on cyl. plate 85	66744088513 45,28		66744088512 49,03	66744088507 60,28	1
2 Q8 R Guarnitura Q8 ros. senza bocc. Lever handle 8mm on rose	66744280513 19,27	66746280513 15,40	66744280512 21,27	66744280507 27,27	1
2 Q8 RB Guarnitura Q8 ros./bocc. patent Lever handle 8mm on rose key hole escutcheon	66744281513 24,60 ⚡	66746281513 18,77	66744281512 27,10 ⚡	66744281507 34,60	1
2 Q8 RBY Guarnitura Q8 ros./bocc. yale Lever handle 8mm on rose - cyl. hole escutcheon	66744285513 24,60 ⚡	66746285513 18,77	66744285512 27,10 ⚡	66744285507 34,60	1
2 Q8 RBWC Guarnitura Q8 ros./bocc. Wc Lever handle 8mm on rose wc hole escutcheon	66744288013 36,03 ⚡	66746288513 30,20	66744288012 40,53 ⚡	66744288007 46,60	1
3 DK X 40 Martellina DK Q7 x 40 window handle DK x 40 mm	66744557013 12,45		66744557012 13,69	66744557007 17,44	2
3 DK X 40 C/BUSS. Martellina DK Q7 x 40 con bussole D. 9,5 window handle DK x 40mm with pins D.9.5	66744558013 12,45		66744558012 13,69	66744558007 17,44	2

⚡ Servizio G48: Articolo a magazzino e disponibile entro 48 dall'elaborazione dell'ordine. In base a disponibilita' e condizioni di vendita.  
G48 service: Item in stock and available within 48 hours of order processing. Based on availability and sales conditions.

PORTA

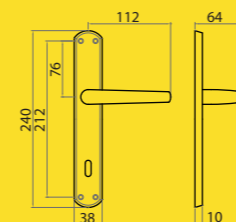

1 Placca MILENA  
Mont. n°38

FINESTRA

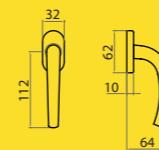

3  
Mont. n°8

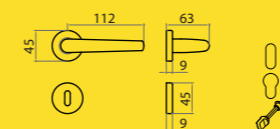

2 Ros 45x9  
Mont. n°88 - 89



Per istruzioni di montaggio scansiona QR code, seleziona il numero di riferimento e segui le istruzioni.  
For assembly instructions scan the QR code, select the relevant assembly number and follow the instructions.

# NION



Z-OSO



Z-BGO



ZCS



ZNO



ZCS

	ZCS	ZNO	Z-BGO	Z-OSO	Conf. Pz.
1 Q8 RB Guarnitura Q8 ros./bocc. patent Lever handle 8mm on rose key hole escutcheon	R0754241713 34,45 ⚡	R0754241716 31,87 ⚡	R0754241764 44,24 ⚡	R0754241766 43,97 ⚡	1
1 Q8 RBY Guarnitura Q8 ros./bocc. yale Lever handle 8mm on rose - cyl. hole escutcheon	R0754245713 34,45 ⚡	R0754245716 31,87 ⚡	R0754245764 44,24 ⚡	R0754245766 43,97 ⚡	1
1 Q8 RBWC Guarnitura Q8 ros./bocc. Wc Lever handle 8mm on rose - wc 6mm function	R0754248713 47,05 ⚡	R0754248716 41,49 ⚡	R0754248764 60,01 ⚡	R0754248766 59,18 ⚡	1
2 DK X 40 ribassato Martellina DK Q7 x 40 ribassato window handle DK x 40 mm thin mechanism	R0754596013 17,35	R0754596016 15,04	R0754596064 20,22	R0754596066 20,34	2
3 DK X 40 C/BUSS Martellina DK Q7 x 40 con bussole D. 9,5 gioco in ferro window handle DK x 40mm with pins D.9.5 iron mechanism	R075400048213 16,43	R075400048216 14,28	R075400048264 20,32	R075400048266 20,44	2

⚡ Servizio G48: Articolo a magazzino e disponibile entro 48 dall'elaborazione dell'ordine. In base a disponibilit  e condizioni di vendita.  
G48 service: Item in stock and available within 48 hours of order processing. Based on availability and sales conditions.

## PORTA

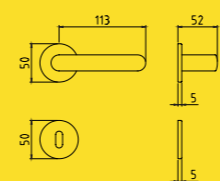

## FINESTRA

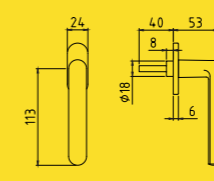

1 Ros ribassata  
(molla dx e sx - maniglia non solidale)



2

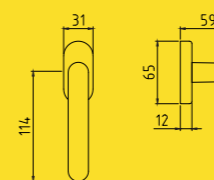

3



Per istruzioni di montaggio  
scansiona QR code,  
seleziona il numero di  
riferimento e segui le  
istruzioni.  
For assembly instructions  
scan the QR code, select the  
relevant assembly number  
and follow the instructions.

# NION Q



ZCS

R0754

Nion Q

Zamak

Handles

	ZCS	ZNO	Z-BGO	Z-OSO	Conf. Pz.
1 Q8 RBQ Guarnitura Q8 ros./bocc. patent Lever handle 8mm on rose key hole escutcheon	R0754241813 38,78 ⚡	R0754241816 31,87 ⚡	R0754241864 49,59 ⚡	R0754241866 49,33 ⚡	1
1 Q8 RBQY Guarnitura Q8 ros./bocc. yale Lever handle 8mm on rose - cyl. hole escutcheon	R0754245813 38,78 ⚡	R0754245816 31,87 ⚡	R0754245864 49,59 ⚡	R0754245866 49,33 ⚡	1
1 Q8 RBQWC Guarnitura Q8 ros./bocc. Wc Lever handle 8mm on rose wc hole escutcheon	R0754248813 50,85 ⚡	R0754248816 41,49 ⚡	R0754248864 65,36 ⚡	R0754248866 64,54 ⚡	1
2 DK X 40 ribassato Martellina DK Q7 x 40 ribassato window handle DK x 40 mm thin mechanism	R0754594013 17,25	R0754594016 14,98	R0754594064 20,13	R0754594066 20,24	2
3 DK X 40 C/BUSS Martellina DK Q7 x 40 con bussole D. 9,5 gioco in ferro window handle DK x 40mm with pins D.9.5 iron mechanism	R075400C48213 16,53	R075400C48216 14,58	R075400C48264 20,59	R075400C48266 20,70	2

⚡ Servizio G48: Articolo a magazzino e disponibile entro 48 dall'elaborazione dell'ordine. In base a disponibilita' e condizioni di vendita.  
G48 service: Item in stock and available within 48 hours of order processing. Based on availability and sales conditions.

PORTA

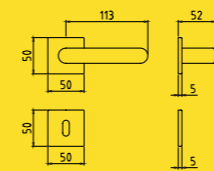

1 Ros ribassata  
(molla dx e sx - maniglia non solidale)  
Mont. n°66-67

FINESTRA

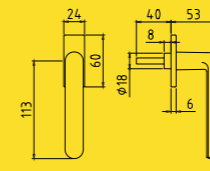

2  
Mont. n°7

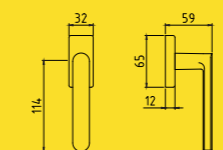

3  
Mont. n°6



Per istruzioni di montaggio scansiona QR code, seleziona il numero di riferimento e segui le istruzioni.  
For assembly instructions scan the QR code, select the relevant assembly number and follow the instructions.

R0754

Nion Q

Zama

Maniglie

# R938

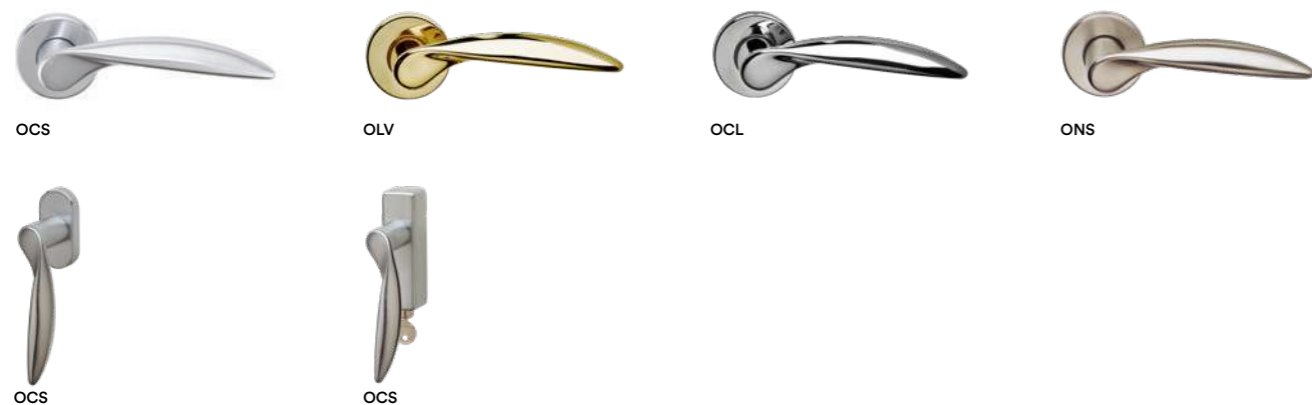
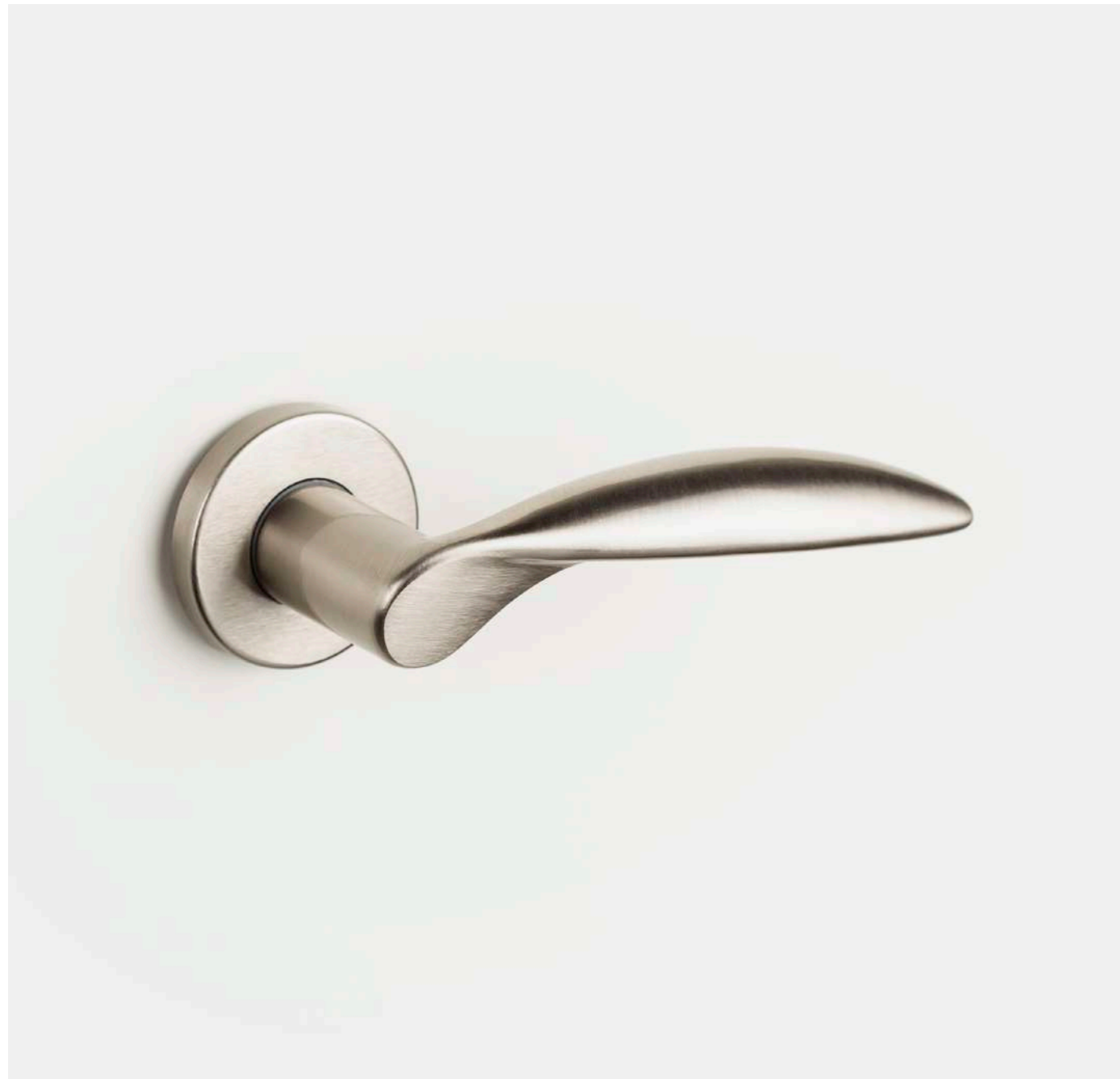

	ZCL	GCTOL	ZCS	ZNS	Conf. Pz.
1 Q8 R Guarnitura Q8 ros. senza bocc. Lever handle 8mm on rose	R09380005050760 63,87	R09380005051260 57,87	R09380005051360 55,87	R09380005052760 71,87	1
1 Q8 RB Guarnitura Q8 ros./bocc. BB Lever handle 8mm on rose - key escutcheon	R09380005120760 71,23	R09380005121260 63,73	R09380005121360 61,23	R09380005122760 81,23	1
1 Q8 RB Guarnitura Q8 ros./bocc. patent Lever handle 8mm on rose - key escutcheon	R09380005100760 71,23	R09380005101260 63,73	R09380005101360 61,23	R09380005102760 81,23	1
1 Q8 RBY Guarnitura Q8 ros./bocc. yale Lever handle 8mm on rose - cyl. hole escutcheon	R09380005500760 71,23	R09380005501260 63,73	R09380005501360 61,23	R09380005502760 81,23	1
1 Q8 RBWC Guarnitura Q8 ros./bocc. Wc Lever handle 8mm on rose - wc 6mm function	R09380005880760 83,23	R09380005881260 75,73	R09380005881360 71,23	R09380005882760 95,23	1
2 DK x 35 C/BUSS. Martellina DK Q7x35 c/bussole D.9,5 mm viti metriche window handle DK x 35 mm with pins D.9,5 metric screws	R09380004800790 38,93	R09380004801290 35,18	R09380004801390 33,93	R09380004802790 43,93	1
3 DK x 42 C/CHIAVE C/BUSS. Martellina con chiave DK Q7x42 c/bus D.9,5 mm viti metriche window handle DK x 42mm with key / pins D.9,5 with screws	R093800A4840790 117,49	R093800A4841290 113,74	R093800A4841390 112,49	R093800A4842790 122,49	1

### PORTA

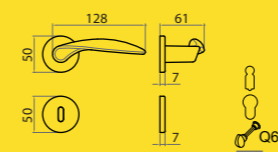

- 1 Ros 0005 On request  
 Mont. n°33

### FINESTRA

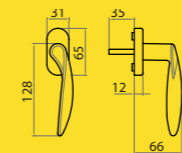

- 2 C/45 Gioco in ferro  
 Mont. n°4

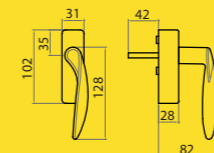

- 3 RG  
 Mont. n°11



Per istruzioni di montaggio scansiona QR code, seleziona il numero di riferimento e segui le istruzioni.  
 For assembly instructions scan the QR code, select the relevant assembly number and follow the instructions.

# RIALTO

DESIGN MESSINEO E SETTIMELLI



66515

Rialto

Zamak

Handles

66515

Rialto

Zama

Maniglie

	ZCL	ZCS	ZNO	Conf. Pz.
1 Q8 RQ Guarnitura Q8 ros. senza bocc. Lever handle 8mm on rose	66515240807 45,75	66515240813 37,75	66515240816 35,95	1
1 Q8 RBQ Guarnitura Q8 ros./bocc. patent Lever handle 8mm on rose key hole escutcheon	66515241807 57,71	66515241813 47,71 ⚡	66515241816 45,46 ⚡	1
1 Q8 RBQY Guarnitura Q8 ros./bocc. yale Lever handle 8mm on rose - cyl. hole escutcheon	66515245807 57,71	66515245813 47,71 ⚡	66515245816 45,46 ⚡	1
1 Q8 RBQWC Guarnitura Q8 ros./bocc. Wc Lever handle 8mm on rose wc hole escutcheon	66515248807 69,71	66515248813 57,71 ⚡	66515248816 55,01 ⚡	1
2 Q8 RBR Guarnitura Q8 ros./bocc. rett. patent molla dx/sx Lever handle 8mm on springloaded rect rose key hole esc	66515211407 79,96	66515211413 69,96	66515211416 67,71	1
2 Q8 RBRY Guarnitura Q8 ros./bocc. rett.yale molla dx/sx Lever handle 8mm on springloaded rect rose cylinder hole esc	66515215407 79,96	66515215413 69,96	66515215416 67,71	1
3 DK X 40 C/BUSS Martellina DK Q7 x 40 con bussole D. 9,5 gioco in ferro window handle DK x 40mm with pins D.9,5 iron mechanism	66515553807 40,66	66515553813 35,66	66515553816 34,53	2
4 DK X 40 ribassato Martellina DK Q7 x 40 ribassato window handle DK x 40 mm thin mechanism	66515594007 40,66	66515594013 35,66	66515594016 34,53	2

⚡ Servizio G48: Articolo a magazzino e disponibile entro 48 dall'elaborazione dell'ordine. In base a disponibilita' e condizioni di vendita.  
G48 service: Item in stock and available within 48 hours of order processing. Based on availability and sales conditions.

### PORTA

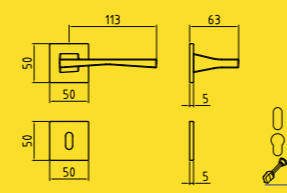

1 Ros 50x50x5  
(molla dx e sx - maniglia non solidale)  
Mont. n°66-67

### FINESTRA

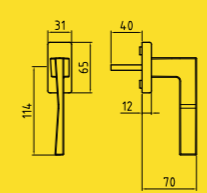

3 Gioco in ferro  
Mont. n°6

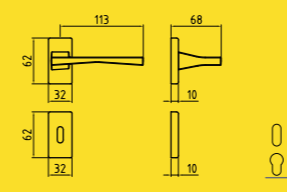

2 Ros 0006  
Mont. n°75

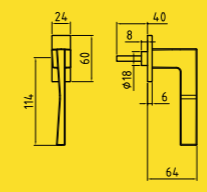

4  
Mont. n°7



Per istruzioni di montaggio scansiona QR code, seleziona il numero di riferimento e segui le istruzioni.  
For assembly instructions scan the QR code, select the relevant assembly number and follow the instructions.

# SEVEN



ZCS

	ZCL	GCTOL	ZCS	ZNS	Conf. Pz.
1 Q8 RT Guarnitura Q8 ros. senza bocc. Lever handle 8mm on rose	66470280907 49,74	66470280912 43,74	66470280913 41,74	66470280927 57,74	1
1 Q8 RBT Guarnitura Q8 ros./bocc. patent Lever handle 8mm on rose key hole escutcheon	66470281907 57,84	66470281912 50,34	66470281913 47,84	66470281927 67,84	1
1 Q8 RBYT Guarnitura Q8 ros./bocc. yale Lever handle 8mm on rose - cyl. hole escutcheon	66470285907 57,84	66470285912 50,34	66470285913 47,84	66470285927 67,84	1
1 Q8 RBTWC Guarnitura Q8 ros./bocc. WC Q6 Lever handle 8mm on rose - wc 6mm function	66470288907 69,84	66470288912 62,34	66470288913 57,84	66470288927 81,84	1
2 Q8 ROC Guarnitura Q8 ros.ovale senza bocc.molla dx/sx Lever handle 8mm on springloaded oval rose	66470220607 53,83	66470220612 47,83	66470220613 45,83	66470220627 61,83	1
2 Q8 RBOC Guarnitura ros./bocc. ovale patent molla dx/sx Lever handle 8mm on springloaded oval rose key hole escutcheon	66470221607 62,82	66470221612 55,32	66470221613 52,82	66470221627 72,82	1
2 Q8 RBOYC Guarnitura Q8 ros/boc. ovale yale molla dx/sx Lever handle 8mm on springloaded oval rose - cyl. hole escutcheon	66470225607 62,82	66470225612 55,32	66470225613 52,82	66470225627 72,82	1
3 DK x 40 Martellina DK Q7x40 window handle DK x 40 mm	66470557007 25,09	66470557012 21,34	66470557013 20,09	66470557027 30,09	2
3 DK X 40 C/BUSS. Martellina DK Q7 x 40 con bussole D.9,5 mm window handle DK x 40mm with pins D.9,5	66470558007 25,09	66470558012 21,34	66470558013 20,09	66470558027 30,09	2

PORTA

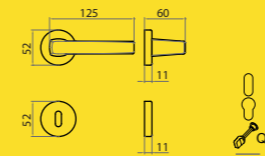

1 Ros 575  
Mont. n°95-96

FINESTRA

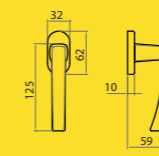

3  
Mont. n°4

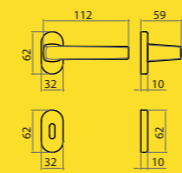

2 Ros 0006  
Mont. n°23



Per istruzioni di montaggio scansiona QR code, seleziona il numero di riferimento e segui le istruzioni.  
For assembly instructions scan the QR code, select the relevant assembly number and follow the instructions.

# SEVEN Q



ZCS

66470

Seven Q

Zamak

Handles

	ZCL	GCTOL	ZCS	ZNS	Conf. Pz.
1 Q8 RQ Guarnitura Q8 ros. senza bocc. Lever handle 8mm on rose	66470210307 53,90	66470210312 47,90	66470210313 45,90	66470210327 61,90	1
1 Q8 RBQ Guarnitura Q8 ros./bocc. patent Lever handle 8mm on rose key hole escutcheon	66470211307 65,58	66470211312 58,08	66470211313 55,58	66470211327 75,58	1
1 Q8 RBQY Guarnitura Q8 ros./bocc. yale Lever handle 8mm on rose - cyl. hole escutcheon	66470215307 65,58	66470215312 58,08	66470215313 55,58	66470215327 75,58	1
1 Q8 RBQWC Guarnitura Q8 ros./bocc. Wc Lever handle 8mm on rose wc hole escutcheon	66470218307 77,58	66470218312 70,08	66470218313 65,58	66470218327 89,58	1
2 Q8 RRC guarnitura rosetta rettangolare Q8 C/M molla dx/sx Lever handle 8mm on springloaded rectangular rose	66470210407 57,25	66470210412 51,25	66470210413 49,25	66470210427 65,25	1
2 Q8 RBR Guarnitura Q8 ros./bocc. rett. patent molla dx/sx Lever handle 8mm on springloaded rect rose key hole esc	66470211407 69,22	66470211412 61,72	66470211413 59,22	66470211427 79,22	1
2 Q8 RBYR Guarnitura Q8 ros./bocc. rett. yale molla dx/sx Lever handle 8mm on springloaded rect rose - cyl. hole esc	66470215407 69,22	66470215412 61,72	66470215413 59,22	66470215427 79,22	1
3 DK x 40 Martellina DK Q7 x 40 window handle DK x 40 mm	66470555007 26,87	66470555012 23,12	66470555013 21,87	66470555027 31,87	2
3 DK X 40 C/BUSS. Martellina DK Q7 x 40 con bussole D.9,5 mm window handle DK x 40mm with pins D.9,5	66470556007 26,87	66470556012 23,12	66470556013 21,87	66470556027 31,87	2

66470

Seven Q

Zama

Maniglie

PORTA

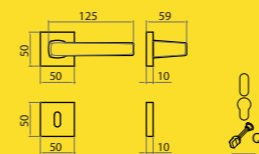

FINESTRA

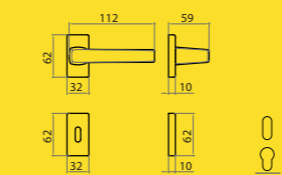
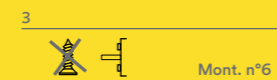
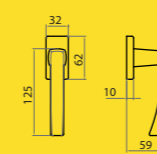

Per istruzioni di montaggio scansiona QR code, seleziona il numero di riferimento e segui le istruzioni.  
For assembly instructions scan the QR code, select the relevant assembly number and follow the instructions.

# SHARK



	ZCS	ZCS/F1-SAT	GCTOL	ZCL	ZNS	Conf. Pz.
1 Q8 P70 Guarnitura Q8 placca patent 70 Lever handle 8mm on plate key hole 70 mm	66480087013 48,88		66480087012 52,63	66480087007 63,88	66480087027 78,88	1
1 Q8 PY85 Guarnitura Q8 placca Yale 85 Lever handle 8mm on cylinder plate 85 mm	66480088513 48,88		66480088512 52,63	66480088507 63,88	66480088527 78,88	1
1 Q8 P90 Guarnitura Q8 placca P90 Lever handle 8mm on plate key hole 90 mm	66480089013 48,88		66480089012 52,63	66480089007 63,88	66480089027 78,88	1
2 Q8 R Guarnitura Q8 ros. senza bocc. Lever handle 8mm on rose	66480230513 25,84		66480230512 27,84	66480230507 33,84	66480230527 41,84	1
2 Q8 RB Guarnitura Q8 ros./bocc. patent Lever handle 8mm on rose key hole escutcheon	66480231513 30,22	66482231513 27,24	66480231512 32,72	66480231507 40,22	66480231527 50,22	1
2 Q8 RBY Guarnitura Q8 ros./bocc. yale Lever handle 8mm on rose - cyl. hole escutcheon	66480235513 30,22	66482235513 27,24	66480235512 32,72	66480235507 40,22	66480235527 50,22	1
2 Q8 RB50WC Guarnitura Q8 ros./bocc. WC Q6 Lever handle 8mm on rose - wc 6mm function	66480238613 40,22		66480238612 44,72	66480238607 52,22	66480238627 64,22	1
3 Q8 ROC Guarnitura Q8 ros.ovale senza bocc. Lever handle 8mm on oval rose	66480220513 39,53		66480220512 41,53	66480220507 47,53	66480220527 55,53	1
3 Q8 RBOC Guarnitura Q8 ros/boc. ovale patent Lever handle 8mm on oval rose key hole escutcheon	66480221513 42,01		66480221512 44,51	66480221507 52,01	66480221527 62,01	1
3 Q8 RBOYC Guarnitura Q8 ros/boc. ovale Yale Lever handle 8mm on oval rose - cyl. hole escutcheon	66480225513 42,01		66480225512 44,51	66480225507 52,01	66480225527 62,01	1
4 MART IM Martellina Q7 imp. Maniglia lever window handle	66480550013 37,20		66480550012 39,20	66480550007 45,20	66480550027 53,20	2
5 DK x 40 C/BUSS 4 scatti Martellina DK Q7 x 40 c/bussole D.9,5 window handle DK x 40 mm with pins D.9,5	66480549513 18,76		66480549512 20,01	66480549507 23,76	66480549527 28,76	2
5 DK x 40 C/BUSS 8 scatti Martellina DK Q7 x 40 c/bussole D.9,5 window handle DK x 40 mm with pins D.9,5	6648054951308 26,03		6648054951208 27,28	6648054950708 31,03	6648054952708 36,03	2
6 DK x 42 C/CHIAVE C/BUSS. Martellina con chiave DK Q7x42 c/bussole D.9,5 window handle DK x 42mm with key / pins D.9,5	66480563513 106,69		66480563512 107,94	66480563507 111,69	66480563527 116,69	1

PORTA

FINESTRA

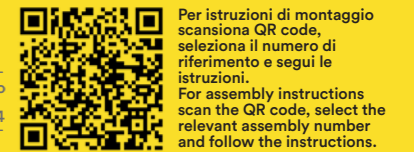
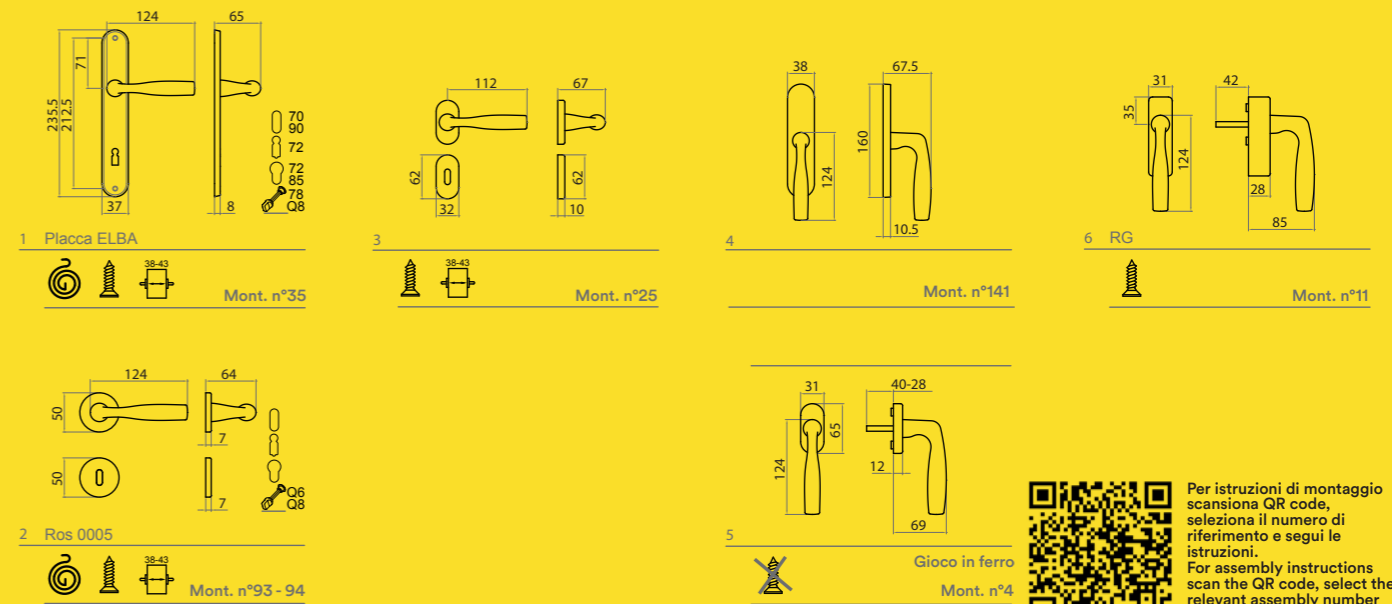



# SWING

DESIGN FRANCESCO LUCCHESI



ZCL



ZCS



ZNO



ZCS

	ZCL	ZCS	ZNO	Conf. Pz.
1 Q8 RBQ Guarnitura Q8 ros./bocc. patent Lever handle 8mm on rose key hole escutcheon	66410241607 69,52	66410241613 59,52	66410241616 57,27	1
1 Q8 RBQY Guarnitura Q8 ros./bocc. yale Lever handle 8mm on rose - cyl. hole escutcheon	66410245607 69,52	66410245613 59,52	66410245616 57,27	1
1 Q8 RBQWC Guarnitura Q8 ros./bocc. Wc Lever handle 8mm on rose wc hole escutcheon	66410248607 81,52	66410248613 69,52	66410248616 66,82	1
2 DK X 40 Martellina DK Q7 x 40 window handle DK x 40 mm	66410555007 26,43	66410555013 21,43	66410555016 20,30	2
2 DK X 40 C/BUSS. Martellina DK Q7 x 40 con bussole D. 9,5 window handle DK x 40mm with pins D.9,5	66410556007 26,43	66410556013 21,43	66410556016 20,30	2

### PORTA

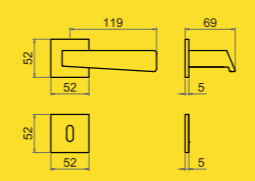

### FINESTRA

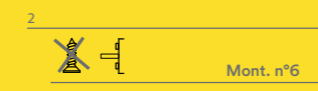
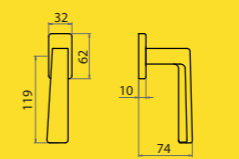

Per istruzioni di montaggio scansiona QR code, seleziona il numero di riferimento e segui le istruzioni.  
For assembly instructions scan the QR code, select the relevant assembly number and follow the instructions.

# TOY



Z-OSO

Z-BGO

ZCS

ZNO



ZCS

R0753

Toy

Zamak

Handles

		ZCS	ZNO	Z-BGO	Z-OSO	Conf. Pz.
1	Q8 RB Guarnitura Q8 ros./bocc. patent Lever handle 8mm on rose key hole escutcheon	R0753241713 34,45 ⚡	R0753241716 31,87 ⚡	R0753241764 44,24 ⚡	R0753241766 43,97 ⚡	1
1	Q8 RBY Guarnitura Q8 ros./bocc. yale Lever handle 8mm on rose - cyl. hole escutcheon	R0753245713 34,45 ⚡	R0753245716 31,87 ⚡	R0753245764 44,24 ⚡	R0753245766 43,97 ⚡	1
1	Q8 RBWC Guarnitura Q8 ros./bocc. Wc Lever handle 8mm on rose - wc 6mm function	R0753248713 47,05 ⚡	R0753248716 41,49 ⚡	R0753248764 60,01 ⚡	R0753248766 59,18 ⚡	1
2	DK X 40 ribassato Martellina DK Q7 x 40 ribassato window handle DK x 40 mm thin mechanism	R0753596013 17,35	R0753596016 15,04	R0753596064 20,22	R0753596066 20,34	2
2	DK X 40 C/BUSS Martellina DK Q7 x 40 con bussole D. 9,5 gioco in ferro window handle DK x 40mm with pins D.9,5 iron mechanism	R075300048213 16,43	R075300048216 14,28	R075300048264 20,32	R075300048266 20,44	2

⚡ Servizio G48: Articolo a magazzino e disponibile entro 48 dall'elaborazione dell'ordine. In base a disponibilita' e condizioni di vendita.  
G48 service: Item in stock and available within 48 hours of order processing. Based on availability and sales conditions.

PORTA

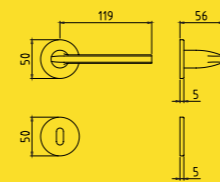

FINESTRA

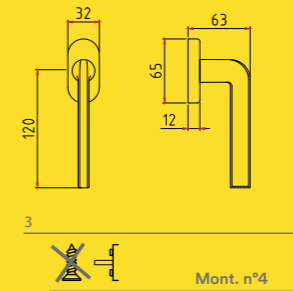
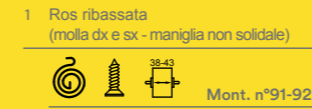
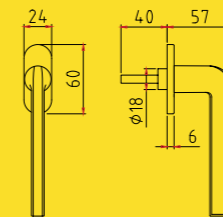

Per istruzioni di montaggio  
scansiona QR code,  
seleziona il numero di  
riferimento e segui le  
istruzioni.  
For assembly instructions  
scan the QR code, select the  
relevant assembly number  
and follow the instructions.

R0753

Toy

Zama

Maniglie

# TOY Q



Z-OSO

Z-BGO

ZCS

ZNO



ZCS

	ZCS	ZNO	Z-BGO	Z-OSO	Conf. Pz.
1 Q8 RBQ Guarnitura Q8 ros./bocc. patent Lever handle 8mm on rose key hole escutcheon	R0753241813 38,78 ⚡	R0753241816 31,87 ⚡	R0753241864 49,59 ⚡	R0753241866 49,33 ⚡	1
1 Q8 RBQY Guarnitura Q8 ros./bocc. yale Lever handle 8mm on rose - cyl. hole escutcheon	R0753245813 38,78 ⚡	R0753245816 31,87 ⚡	R0753245864 49,59 ⚡	R0753245866 49,33 ⚡	1
1 Q8 RBQWC Guarnitura Q8 ros./bocc. Wc Lever handle 8mm on rose wc hole escutcheon	R0753248813 50,85 ⚡	R0753248816 41,49 ⚡	R0753248864 65,36 ⚡	R0753248866 64,54 ⚡	1
2 DK X 40 ribassato Martellina DK Q7 x 40 ribassato window handle DK x 40 mm thin mechanism	R0753594013 17,25	R0753594016 14,98	R0753594064 20,13	R0753594066 20,24	2
3 DK X 40 C/BUSS Martellina DK Q7 x 40 con bussole D. 9,5 gioco in ferro window handle DK x 40mm with pins D.9.5 iron mechanism	R075300C48213 16,53	R075300C48216 14,58	R075300C48264 20,59	R075300C48266 20,70	2

⚡ Servizio G48: Articolo a magazzino e disponibile entro 48 dall'elaborazione dell'ordine. In base a disponibilita' e condizioni di vendita.  
 ⚡ G48 service: Item in stock and available within 48 hours of order processing. Based on availability and sales conditions.

### PORTA

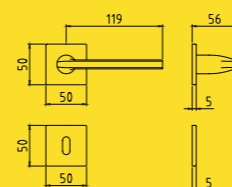

### FINESTRA

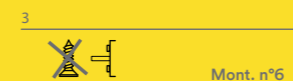
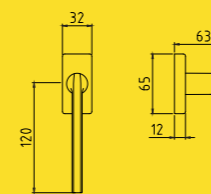
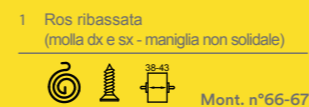
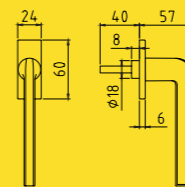

Per istruzioni di montaggio  
scansiona QR code,  
seleziona il numero di  
riferimento e segui le  
istruzioni.  
For assembly instructions  
scan the QR code, select the  
relevant assembly number  
and follow the instructions.

# UNO Z



	ZCS	ZCS/F1-SAT	GCTOL	ZCL	ZNS	ZNO	Conf. Pz.
1 Q8 P90 Guarnitura Q8 placca patent 90 Lever handle 8mm on key plate 90	66546089013 47,29		66546089012 45,69	66546089007 68,33		66546089016 43,14	1
1 Q8 P70 Guarnitura Q8 placca patent 70 Lever handle 8mm on key plate 70	66546087013 47,29		66546087012 45,69	66546087007 68,33		66546087016 43,14	1
1 Q8 PY85 Guarnitura Q8 placca yale 85 Lever handle 8mm on cyl. plate 85	66546088513 47,29		66546088512 45,69	66546088507 68,33		66546088516 43,14	1
2 Q8 R Guarnitura Q8 ros. senza bocc. Lever handle 8mm on rose	66546280013 24,29	66547280013 16,60	66546280012 26,29	66546280007 32,29	66546280027 40,29	66546280016 22,49	1
2 Q8 RB Guarnitura Q8 ros./bocc. patent Lever handle 8mm on rose key hole escutcheon	66546281013 25,69	66547281013 18,00	66546281012 28,19	66546281007 35,69	66546281027 45,69	66546281016 23,44	1
2 Q8 RBY Guarnitura Q8 ros./bocc. yale Lever handle 8mm on rose - cyl. hole escutcheon	66546285013 25,69	66547285013 18,00	66546285012 28,19	66546285007 35,69	66546285027 45,69	66546285016 23,44	1
2 Q8 RBWC Guarnitura Q8 ros./bocc. Wc Lever handle 8mm on rose wc hole escutcheon	66546288013 37,11	66547288013 26,00	66546288012 41,61	66546288007 49,11	66546288027 61,11	66546288016 34,41	1
3 DK X 40 Martellina DK Q7 x 40 window handle DK x 40 mm	66546557013 13,05		66546557012 14,30	66546557007 18,05	66546557027 23,05	66546557016 11,92	2
3 DK X 40 C/BUSS. Martellina DK Q7 x 40 con bussole D. 9,5 window handle DK x 40mm with pins D.9,5	66546558013 13,05		66546558012 14,30	66546558007 18,05	66546558027 23,05	66546558016 11,92	2

⚡ Servizio G48: Articolo a magazzino e disponibile entro 48 dall'elaborazione dell'ordine. In base a disponibilita' e condizioni di vendita.  
G48 service: Item in stock and available within 48 hours of order processing. Based on availability and sales conditions.

PORTA

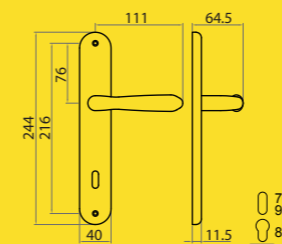

1 Placca UNO  
Mont. n°36

FINESTRA

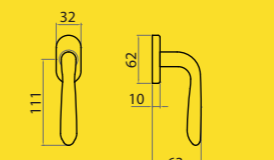

6  
Mont. n°8

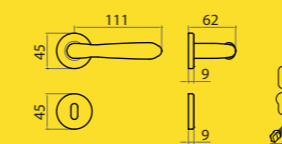

3 Ros 45X9  
Mont. n°88-89



Per istruzioni di montaggio scansiona QR code, seleziona il numero di riferimento e segui le istruzioni.  
For assembly instructions scan the QR code, select the relevant assembly number and follow the instructions.

# VICTORIA



ZGV



GCTOL



GCTOL



OLV

		GCTOL	OLV	ZGV	OGV	Conf. Pz.
1	Q8 P90 Guarnitura Q8 placca patent 90 Lever handle 8mm on key plate 90	66246089012		66246089004		1
1	Q8 P70 Guarnitura Q8 placca patent 70 Lever handle 8mm on key plate 70	66246087012		66246087004		1
1	Q8 PY85 Guarnitura Q8 placca yale 85 Lever handle 8mm on cyl. plate 85	66246088512		66246088504		1
2	Q8 P90RS Guarnitura Q8 placca stretta pat 90 Lever handle 8mm on reduced key plate 90	66246051012		66246051004		1
2	Q8 P70RS Guarnitura Q8 placca stretta pat 70 Lever handle 8mm on reduced key plate 70	66246057012		66246057004		1
2	Q8 PY85RS Guarnitura Q8 placca stretta yale 85 Lever handle 8mm on reduced cyl. plate 85	66246055012		66246055004		1
3	Q8 R Guarnitura Q8 ros. senza bocc. Lever handle 8mm on rose	66246280012		66246280004		1
3	Q8 RB Guarnitura Q8 ros./bocc. patent Lever handle 8mm on rose key hole escutcheon	66246281012		66246281004		1
3	Q8 RBY Guarnitura Q8 ros./bocc. yale Lever handle 8mm on rose - cyl. hole escutcheon	66246285012		66246285004		1
3	Q8 RBWC Guarnitura Q8 ros./bocc. Wc Lever handle 8mm on rose wc hole escutcheon	66246288012		66246288004		1
3	Q8 ROC Guarnitura Q8 ros.ovale senza bocc. Lever handle 8mm on oval rose	66246220512		66246220504		1
4	Q8 RBOC Guarnitura Q8 ros/boc. ovale patent Lever handle 8mm on oval rose key hole escutcheon	66246221512		66246221504		1
4	Q8 RBOYC Guarnitura Q8 ros/boc. ovale Yale Lever handle 8mm on oval rose - cyl. hole escutcheon	66246225512		66246225504		1
5	MART Martellina Q7 window handle		55010500001		55010500004	2
6	DK X 40 Martellina DK Q7 x 40 window handle DK x 40 mm	66246557012		66246557004		2
6	DK X 40 C/BUSS. Martellina DK Q7 x 40 con bussole D. 9,5 window handle DK x 40mm with pins D.9.5	66246558012		66246558004		2

⚡ Servizio G48: Articolo a magazzino e disponibile entro 48 dall'elaborazione dell'ordine. In base a disponibilita' e condizioni di vendita.  
G48 service: Item in stock and available within 48 hours of order processing. Based on availability and sales conditions.

PORTA

FINESTRA

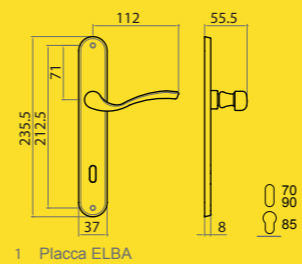

1 Placca ELBA  
Mont. n°35

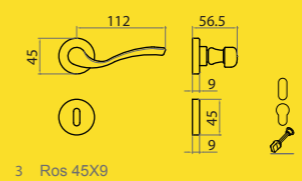

3 Ros 45X9  
Mont. n°88-89

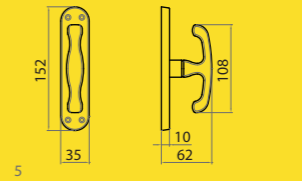

5  
Mont. n°143

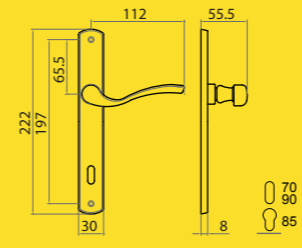

2 Placca STRETTA  
Mont. n°37

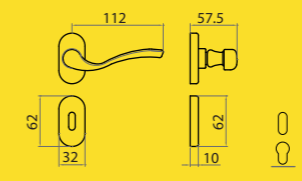

4 Ros 0006  
Mont. n°25

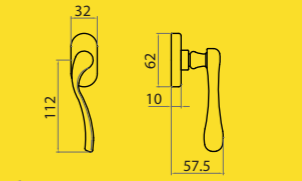

6  
Mont. n°4



Per istruzioni di montaggio scansiona QR code, seleziona il numero di riferimento e segui le istruzioni.  
For assembly instructions scan the QR code, select the relevant assembly number and follow the instructions.

# WING



ACS

ACL



ACL

77792

Wing

Aluminum

Handles

	ACS	ACL	Conf. Pz.
1 Q8 RQ Guarnitura Q8 ros. senza bocc. Lever handle 8mm on rose	77792280013 79,16	77792280017 79,16	1
1 Q8 RBQ Guarnitura Q8 ros./bocc. patent Lever handle 8mm on rose key hole escutcheon	77792281013 91,07	77792281017 91,07	1
1 Q8 RBQY Guarnitura Q8 ros./bocc. yale Lever handle 8mm on rose - cyl. hole escutcheon	77792285013 91,07	77792285017 91,07	1
1 Q8 RBWCQ Guarnitura Q8 ros./bocc. Wc Lever handle 8mm on rose wc hole escutcheon	77792288013 110,56	77792288017 110,56	1
2 DK x 40 Martellina DK Q7 x 40 window handle DK x 40 mm	77792555013 51,04	77792555017 51,04	2
2 DK X 40 C/BUS Martellina DK Q7 x 40 con bussole D. 9,5 window handle DK x 40mm with pins D.9,5	77792556013 51,04	77792556017 51,04	2

77792

Wing

Alluminio

Maniglie

### PORTA

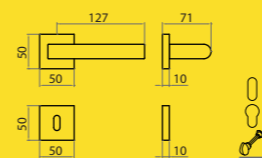

1 Ros 574

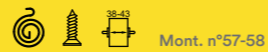

Mont. n°57-58

### FINESTRA

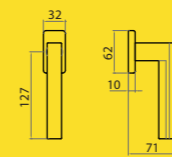

2



Mont. n°6



Per istruzioni di montaggio  
scansiona QR code,  
seleziona il numero di  
riferimento e segui le  
istruzioni.  
For assembly instructions  
scan the QR code, select the  
relevant assembly number  
and follow the instructions.



ZCL

ZNS



ZCS

	ZCL	ZCS	ZNS	Conf. Pz.
1 Q8 RT Guarnitura Q8 ros. Senza bocc. Lever handle 8mm on rose	66460280907 47,73	66460280913 39,73	66460280927 55,73	1
1 Q8 RBT Guarnitura Q8 ros./bocc. patent Lever handle 8mm on rose key hole escutcheon	66460281907 56,87	66460281913 46,87	66460281927 66,87	1
1 Q8 RBTY Guarnitura Q8 ros./bocc. yale Lever handle 8mm on rose - cyl. hole escutcheon	66460285907 56,87	66460285913 46,87	66460285927 66,87	1
1 Q8 RBTWC Guarnitura Q8 ros./bocc. Wc Lever handle 8mm on rose wc hole escutcheon	66460288907 68,87	66460288913 56,87	66460288927 80,87	1
2 Q8 ROC Guarnitura Q8 ros.ovale senza bocc.molla dx/sx Lever handle 8mm on springloaded oval rose	66460220607 56,36	66460220613 48,36	66460220627 64,36	1
2 Q8 RBOC Guarnitura Q8 ros./bocc. patent Lever handle 8mm on rose key hole escutcheon	66460221607 66,25	66460221613 56,25	66460221627 76,25	1
2 Q8 RBOYC Guarnitura Q8 ros./bocc. yale Lever handle 8mm on rose - cyl. hole escutcheon	66460225607 66,25	66460225613 56,25	66460225627 76,25	1
3 DK X 40 Martellina DK Q7 x 40 window handle DK x 40 mm	66460567007 24,64	66460567013 19,64	66460567027 29,64	2
3 DK X 40 C/BUSS. Martellina DK Q7 x 40 con bussole D. 9,5 window handle DK x 40mm with pins D.9,5	66460568007 24,64	66460568013 19,64	66460568027 29,64	2

PORTA

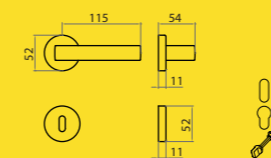

1 Ros 575  
Mont. n°95-96

FINESTRA

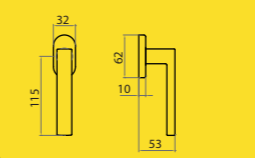

3  
Mont. n°4

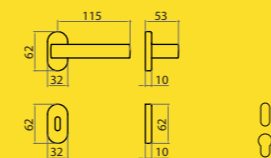

2 Ros 0006  
Mont. n°23



Per istruzioni di montaggio  
scansiona QR code,  
seleziona il numero di  
riferimento e segui le  
istruzioni.  
For assembly instructions  
scan the QR code, select the  
relevant assembly number  
and follow the instructions.

# YORK 4



66460

York 4

Zamak

Handles

	ZCL	ZCS	ZNO	RAL9010-opaco	Conf. Pz.
1 Q8 RQ 50x50x5 Guarnitura Q8 ros. senza bocc. Lever handle 8mm on rose	66460240607 43,18	66460240613 35,18	66460240616 33,38	66460240663 33,38	1
1 Q8 RBQ 50x50x5 Guarnitura Q8 ros./bocc. patent Lever handle 8mm on rose key hole escutcheon	66460241607 53,58	66460241613 43,58	66460241616 43,58 ⚡	66460241663 43,58 ⚡	1
1 Q8 RBQY 50x50x5 Guarnitura Q8 ros./bocc. yale Lever handle 8mm on rose - cyl. hole escutcheon	66460245607 53,58	66460245613 43,58	66460245616 43,58 ⚡	66460245663 43,58 ⚡	1
1 Q8 RBQWC 50x50x5 Guarnitura Q8 ros./bocc. Wc Lever handle 8mm on rose wc hole escutcheon	66460248607 65,58	66460248613 53,58	66460248616 53,13 ⚡	66460248663 53,13 ⚡	1

⚡ Servizio G48: Articolo a magazzino e disponibile entro 48 dall'elaborazione dell'ordine. In base a disponibilita' e condizioni di vendita.  
G48 service: Item in stock and available within 48 hours of order processing. Based on availability and sales conditions.

66460

York 4

Zama

Maniglie

### PORTA

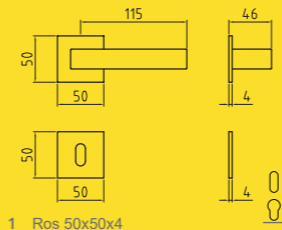

1 Ros 50x50x4



Per istruzioni di montaggio  
scansiona QR code,  
seleziona il numero di  
riferimento e segui le  
istruzioni.  
For assembly instructions  
scan the QR code, select the  
relevant assembly number  
and follow the instructions.



# YORK BERRY



BERRY CHAMPAGNE

	CHAMPAGNE	NORMANDIA	LORENA	BORGOGNA	Conf. Pz.
1 Q8 RQ Guarnitura Q8 ros. senza bocc. Lever handle 8mm on rose	664600544054360	664600544054460	664600544054660	664600544054760	1
1 Q8 RBQ Guarnitura Q8 ros./bocc. patent Lever handle 8mm on rose key hole escutcheon	664600544104360	664600544104460	664600544104660	664600544104760	1
1 Q8 RBQY Guarnitura Q8 ros./bocc. yale Lever handle 8mm on rose - cyl. hole escutcheon	664600544504360	664600544504460	664600544504660	664600544504760	1
1 Q8 RBQWC Guarnitura Q8 ros./bocc. Wc Lever handle 8mm on rose wc hole escutcheon	664600544884360	664600544884460	664600544884660	664600544884760	1
2 Q8 RRC guarnitura rosetta rettangolare Q8 C/M molla dx/sx Lever handle 8mm on springloaded rectangular rose	66460210443	66460210444	66460210446	66460210447	1
2 Q8 RBR Guarnitura Q8 ros./bocc. rett. patent molla dx/sx Lever handle 8mm on springloaded rect rose key hole esc	66460211443	66460211444	66460211446	66460211447	1
2 Q8 RBYR Guarnitura Q8 ros./bocc. rett.yale molla dx/sx Lever handle 8mm on springloaded rect rose - cyl. hole esc	66460215443	66460215444	66460215446	66460215447	1
3 DK X 40 Martellina DK Q7 x 40 window handle DK x 40 mm	66460557043	66460557044	66460557046	66460557047	2
3 DK X 40 C/BUSS. Martellina DK Q7 x 40 con bussole D. 9,5 window handle DK x 40mm with pins D.9,5	66460558043	66460558044	66460558046	66460558047	2

PORTA

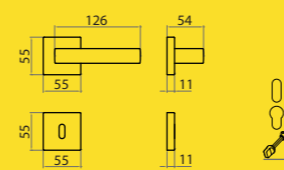

1 Ros 544



Mont. n°68-69

FINESTRA

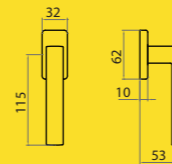

3



Mont. n°6

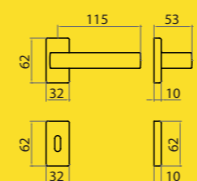

2 0006



Mont. n°75



Per istruzioni di montaggio scansiona QR code, seleziona il numero di riferimento e segui le istruzioni.  
For assembly instructions scan the QR code, select the relevant assembly number and follow the instructions.

# YORK Q

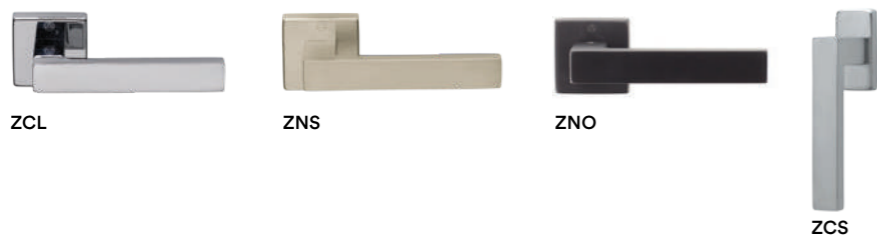

	ZCL	ZCS	ZNO	ZNS	Conf. Pz.
1 Q8 RQ Guarnitura Q8 ros. senza bocc. Lever handle 8mm on rose	66460280007 39,10	66460280013 31,10	66460280016 29,30	66460280027 47,10	1
1 Q8 RBQ Guarnitura Q8 ros./bocc. patent Lever handle 8mm on rose key hole escutcheon	66460281007 49,50	66460281013 39,50 ⚡	66460281016 37,25	66460281027 59,50	1
1 Q8 RBQY Guarnitura Q8 ros./bocc. yale Lever handle 8mm on rose - cyl. hole escutcheon	66460285007 49,50	66460285013 39,50 ⚡	66460285016 37,25	66460285027 59,50	1
1 Q8 RBQWC Guarnitura Q8 ros./bocc. Wc Lever handle 8mm on rose wc hole escutcheon	66460288007 61,50	66460288013 49,50 ⚡	66460288016 46,80	66460288027 73,50	1
2 Q8 RRC guarnitura rosetta rettangolare Q8 C/M molla dx/sx Lever handle 8mm on springloaded rectangular rose	66460210407 59,04	66460210413 51,04	66460210416 49,24	66460210427 67,04	1
2 Q8 RBR Guarnitura Q8 ros./bocc. rett. patent molla dx/sx Lever handle 8mm on springloaded rect rose key hole esc	66460211407 71,60	66460211413 61,60	66460211416 59,35	66460211427 81,60	1
2 Q8 RBYR Guarnitura Q8 ros./bocc. rett.yale molla dx/sx Lever handle 8mm on springloaded rect rose - cyl. hole esc	66460215407 71,60	66460215413 61,60	66460215416 59,35	66460215427 81,60	1
3 DK X 40 Martellina DK Q7 x 40 window handle DK x 40 mm	66460557007 26,43	66460557013 21,43	66460557016 20,30	66460557027 31,43	2
3 DK X 40 C/BUSS. Martellina DK Q7 x 40 con bussole D. 9,5 window handle DK x 40mm with pins D.9,5	66460558007 23,01	66460558013 18,01	66460558016 16,88	66460558027 28,01	2

⚡ Servizio G48: Articolo a magazzino e disponibile entro 48 dall'elaborazione dell'ordine. In base a disponibilita' e condizioni di vendita.  
G48 service: Item in stock and available within 48 hours of order processing. Based on availability and sales conditions.

PORTA

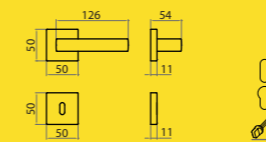

FINESTRA

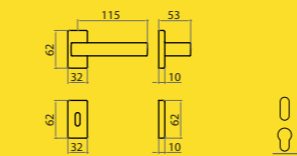
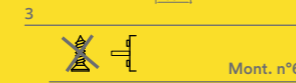
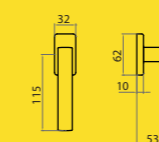

Per istruzioni di montaggio scansiona QR code, seleziona il numero di riferimento e segui le istruzioni.  
For assembly instructions scan the QR code, select the relevant assembly number and follow the instructions.

# Ottone

# Brass

118 Introduzione / Introduction  
120 Finiture / Finishes

122 ARIETE  
124 BAROCCO  
126 EASY  
128 EASY Q  
130 ELBA  
132 ELITE  
134 GINEVRA  
136 GOLF  
138 LADY  
140 LINEA  
142 MILENA  
144 NOVECENTO  
146 PIGNA  
148 R5200  
150 R716  
152 R716  
154 R771  
156 R775  
158 R901  
160 R988  
162 R988  
164 TIROL  
166 UNO

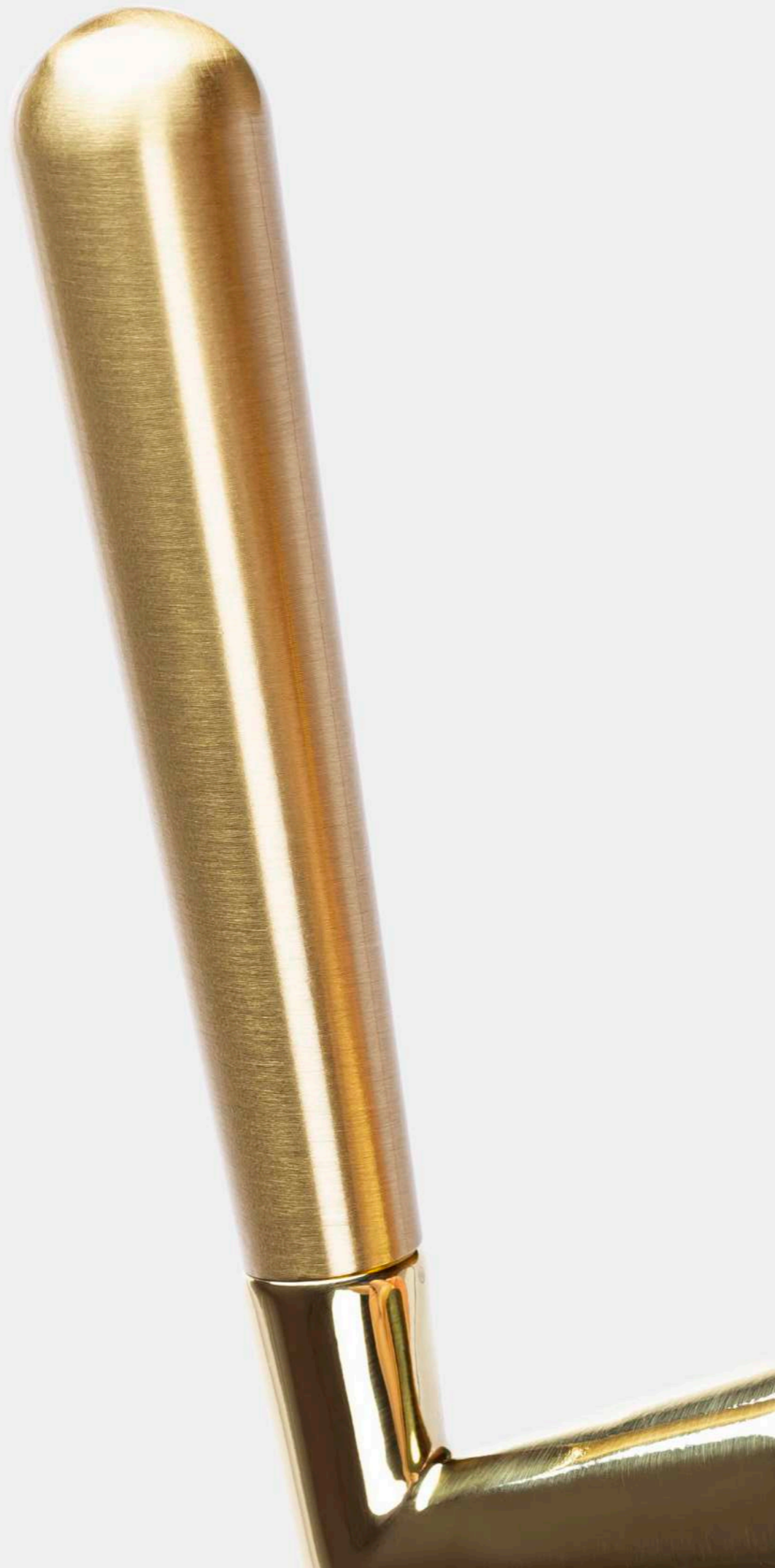

L'ottone é una lega industriale di rame-zinco, nella quale il tenore di zinco é almeno del 50%. I primi utilizzi del rame e delle sue leghe risalgono a 5000 anni fa. Nel nostro caso la lega rappresenta una parte consistente della produzione e nei nostri stabilimenti viene trasformata dallo stato grezzo a semilavorati mediante processi di pressofusione, stampaggio a caldo, tranciatura e imbutitura, tornitura a seconda che si parta da lingotti, spezzoni di barra estrusa, lamiera, barra trafilata.

Brass is an industrial alloy of copper and zinc, of which zinc makes up at least 50%. The first use of copper and its alloys dates back to 5000 years ago. In our case the alloy represents a consistent part of our production and in our factories it is transformed from the original state to semi-finished products using processes of die casting, hot pressing, blanking and drawing, and turning according to whether the product is manufactured from ingots, cut down sizes of extruded bars, sheet or drawn bars.

# Finiture Ottone Brass finishing

OLD	01	121
OANT	02	
OCL - BLACK	03	
OCS-PB	04	
OLS	05	
ONL-EB	06	
OLV	07	
OGV	08	
OBR	09	
OCL-OCS	10	
ONL	11	
OFA	12	
OFA-NO	13	
OCL	14	
GPLUS	15	
ONS	16	
OCL-PB	17	
OCS	18	
OCL-F1	19	
OCL-WHITE	20	



120

01

02

01

13

121

04

11

03

14

07

12

06

17

05

16

15

Brass

Ottone

09

19

08

18

10

20

01

Handles

Maniglie

# ARIETE



OCS



OCL



G-PLUS

	OLV	OCS	OCL	Conf. Pz.
1 PSQ8 RB Pomolo spostato Q8 ros.bocc.patent knob on rose with escutcheon key hole	55696702201 77,35	55696702203 74,85	55696702207 84,85	1
1 PS Q8 RBY Pomolo spostato Q8 ros.bocc.yale knob on rose with escutcheon cyl. hole	55696702601 77,35	55696702603 74,85	55696702607 84,85	1
2 PS Q8 RBOC Pomolo spostato Q8 ros.bocc.ovale copr.patent molla knob on springloaded oval rose with escutcheon key hole	55696702301 84,79	55696702303 82,29	55696702307 92,29	1
2 PS Q8 RBOYC Pomolo spostato Q8 ros.bocc.ovale copr.yale molla knob on springloaded oval rose with escutcheon cyl. hole	55696702701 84,79	55696702703 82,29	55696702707 92,29	1

### PORTA

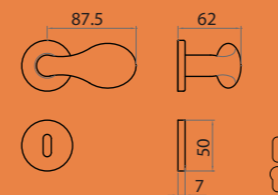

1 Ros 0005

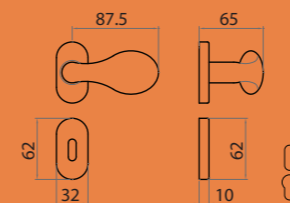

2 Ros 0006



Per istruzioni di montaggio  
scansiona QR code,  
seleziona il numero di  
riferimento e segui le  
istruzioni.  
For assembly instructions  
scan the QR code, select the  
relevant assembly number  
and follow the instructions.

# BAROCCO

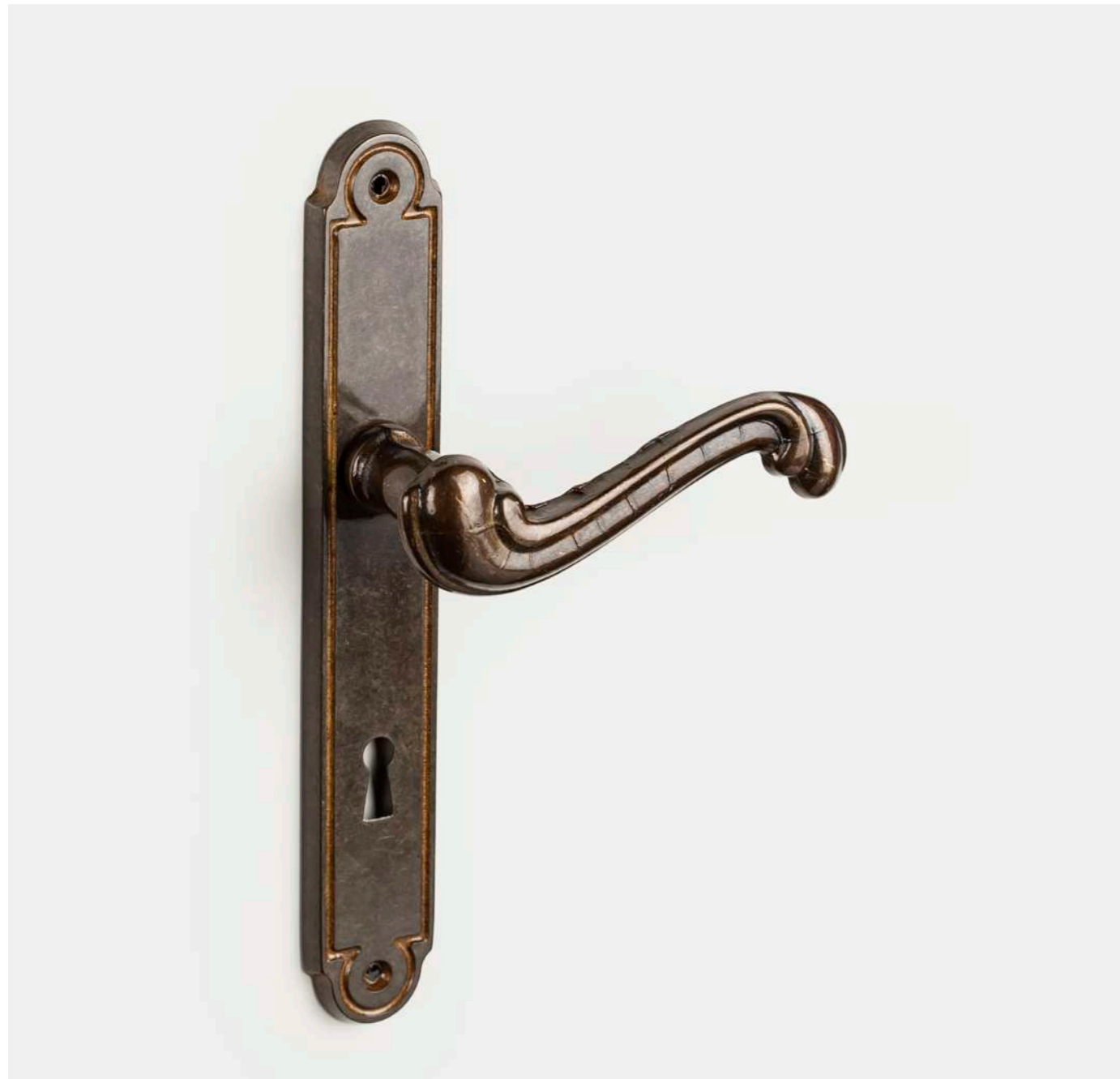

OBR

	OBR	Conf. Pz.
1 Q8 P90 Guarnitura Q8 placca patent 90 Lever handle 8mm on key plate 90	44290089000 27,53	6
1 Q8 P70 Guarnitura Q8 placca patent 70 Lever handle 8mm on key plate 70	44290087000 27,53	6
1 Q8 PY85 Guarnitura Q8 placca yale 85 Lever handle 8mm on cyl. plate 85	44290088500 27,53	6
2 GZ Cremonese gioco GZ Mechanism for window handle spindle 7 mm	44290401000 24,25	10
2 GZP Cremonese gioco GZ + PERNI Mechanism for window handle spindle 7 mm	44290402000 24,85	10
2 GZQ7 Cremonese gioco GZ + Q7 Mechanism for window handle spindle 7 mm	44290403000 24,85	10
2 MART Martellina Q7 window handle	44290500000 23,21	10

### PORTA

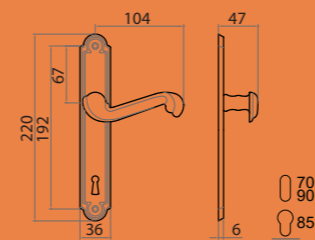

1 Placca BAROCCO



Mont. n°42

### FINESTRA

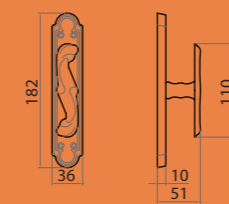

2

Mont. n°147



Per istruzioni di montaggio  
scansiona QR code,  
seleziona il numero di  
riferimento e segui le  
istruzioni.  
For assembly instructions  
scan the QR code, select the  
relevant assembly number  
and follow the instructions.

# EASY

DESIGN FABRIZIO BIANCHETTI



	OLV	OCS	OCL	Conf. Pz.
1 Q8 R Guarnitura Q8 ros. senza bocc. Lever handle 8mm on rose	55014280001 66,13	55014280003 64,13	55014280007 72,13	1
1 Q8 RB Guarnitura Q8 ros./bocc. patent Lever handle 8mm on rose key hole escutcheon	55014281001 72,88	55014281003 70,38	55014281007 80,38	1
1 Q8 RBY Guarnitura Q8 ros./bocc. yale Lever handle 8mm on rose - cyl. hole escutcheon	55014285001 72,88	55014285003 70,38	55014285007 80,38	1
1 Q8 RBWC Guarnitura Q8 ros./bocc. Wc Lever handle 8mm on rose wc hole escutcheon	55014288001 84,88	55014288003 80,38	55014288007 92,38	1
2 Q8 ROC Guarnitura Q8 ros.ovale senza bocc molla Lever handle 8mm on springloaded oval rose	55014220501 67,62	55014220503 65,62	55014220507 73,62	1
2 Q8 RBOC Guarnitura Q8 ros/boc. ovale patent molla Lever handle 8mm on springloaded oval rose key hole escutcheon	55014221501 77,50	55014221503 75,00	55014221507 85,00	1
2 Q8 RBOYC Guarnitura Q8 ros/boc. ovale yale molla Lever handle 8mm on oval rose - cyl. hole escutcheon	55014225501 77,50	55014225503 75,00	55014225507 85,00	1
3 EZ IM Cremonese gioco EZ imp. maniglia Mechanism for window handle spindle 7 mm	55014456001 45,75	55014456003 43,75	55014456007 51,75	2
3 EZQ7 IM Cremonese gioco EZ + Q7 imp. maniglia Mechanism for window handle spindle 7 mm	55014457001 47,38	55014457003 45,38	55014457007 53,38	2
3 MART IM Martellina Q7 imp. Maniglia lever window handle	55014550001 47,38	55014550003 45,38	55014550007 53,38	2
4 DK X 40 Martellina DK Q7 x 40 window handle DK x 40 mm	55014557001 35,62	55014557003 34,37	55014557007 39,37	2
4 DK X 40 C/BUSS Martellina DK Q7 x 40 con bussole D. 9,5 window handle DK x 40mm with pins D.9,5	55014558001 35,62	55014558003 34,37	55014558007 39,37	2

### PORTA

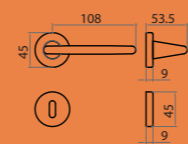

1 Ros 45x9



Mont. n°88-89

### FINESTRA

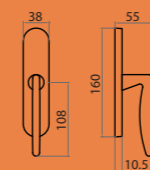

3

Mont. n°140-141

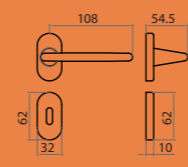

2 Ros 0006



Mont. n°25

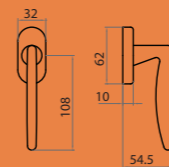

4

Mont. n°8



Per istruzioni di montaggio scansiona QR code, seleziona il numero di riferimento e segui le istruzioni.  
For assembly instructions scan the QR code, select the relevant assembly number and follow the instructions.



# EASY Q

DESIGN FABRIZIO BIANCHETTI



	OLV	OCS	OCL	Conf. Pz.
1 Q8 RQ Guarnitura Q8 ros. senza bocc. Lever handle 8mm on rose	55062280001 75,51	55062280003 73,51	55062280007 81,51	1
1 Q8 RBQ Guarnitura Q8 ros./bocc. patent Lever handle 8mm on rose key hole escutcheon	55062281001 88,51	55062281003 86,01	55062281007 96,01	1
1 Q8 RBQY Guarnitura Q8 ros./bocc. yale Lever handle 8mm on rose - cyl. hole escutcheon	55062285001 88,51	55062285003 86,01	55062285007 96,01	1
1 Q8 RBQWC Guarnitura Q8 ros./bocc. Wc Lever handle 8mm on rose wc hole escutcheon	55062288001 100,51	55062288003 96,01	55062288007 108,01	1
2 DK X 40-35 Martellina DK Q7 x 40 window handle DK x 40 mm	55062557001 37,26	55062557003 36,01	55062557007 41,01	2
2 DK X 40-35 C/BUSS. Martellina DK Q7 x 40 con bussole D. 9,5 window handle DK x 40mm with pins D.9,5	55062558001 37,26	55062558003 36,01	55062558007 41,01	2

### PORTA

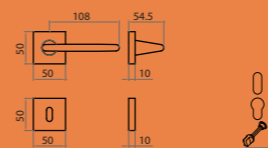

### FINESTRA

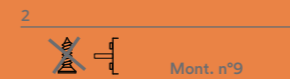
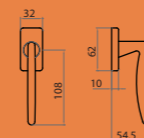

Per istruzioni di montaggio  
scansiona QR code,  
seleziona il numero di  
riferimento e segui le  
istruzioni.  
For assembly instructions  
scan the QR code, select the  
relevant assembly number  
and follow the instructions.



OCS

OCL

	OLV	OCS	OCL	Conf. Pz.
1 Q8 P90 Guarnitura Q8 placca patent 90 Lever handle 8mm on key plate 90	55450089001 40,35	55450089003 36,60	55450089007 51,60	1
1 Q8 P70 Guarnitura Q8 placca patent 70 Lever handle 8mm on key plate 70	55450087001 40,35	55450087003 36,60	55450087007 51,60	1
1 Q8 PY85 Guarnitura Q8 placca yale 85 Lever handle 8mm on cyl. plate 85	55450088501 40,35	55450088503 36,60	55450088507 51,60	1
2 Q8 P90RS Guarnitura Q8 placca stretta pat 90 Lever handle 8mm on reduced key plate 90	55450051001 44,07	55450051003 40,32	55450051007 55,32	1
2 Q8 P70RS Guarnitura Q8 placca stretta pat 70 Lever handle 8mm on reduced key plate 70	55450057001 44,07	55450057003 40,32	55450057007 55,32	1
2 Q8 PY85RS Guarnitura Q8 placca stretta yale 85 Lever handle 8mm on reduced cyl. plate 85	55450055001 44,07	55450055003 40,32	55450055007 55,32	1
3 Q8 R Guarnitura Q8 ros. senza bocc. Lever handle 8mm on rose	55450280001 27,89	55450280003 25,89	55450280007 33,89	1
3 Q8 RB Guarnitura Q8 ros./bocc. patent Lever handle 8mm on rose key hole escutcheon	55450281001 36,58	55450281003 34,08	55450281007 44,08	1
3 Q8 RBY Guarnitura Q8 ros./bocc. yale Lever handle 8mm on rose - cyl. hole escutcheon	55450285001 36,58	55450285003 34,08	55450285007 44,08	1
3 Q8 RBWC Guarnitura Q8 ros./bocc. Wc Lever handle 8mm on rose wc hole escutcheon	55450288001 48,58	55450288003 44,08	55450288007 56,08	1
4 Q8 ROC Guarnitura Q8 ros. ovale senza bocc. Lever handle 8mm on oval rose	55450220501 30,57	55450220503 28,57	55450220507 36,57	1
4 Q8 RBOC Guarnitura Q8 ros/boc. ovale patent Lever handle 8mm on oval rose key hole escutcheon	55450221501 40,00	55450221503 37,50	55450221507 47,50	1
4 Q8 RBOYC Guarnitura Q8 ros/boc. ovale Yale Lever handle 8mm on oval rose - cyl. hole escutcheon	55450225501 40,00	55450225503 37,50	55450225507 47,50	1

PORTA

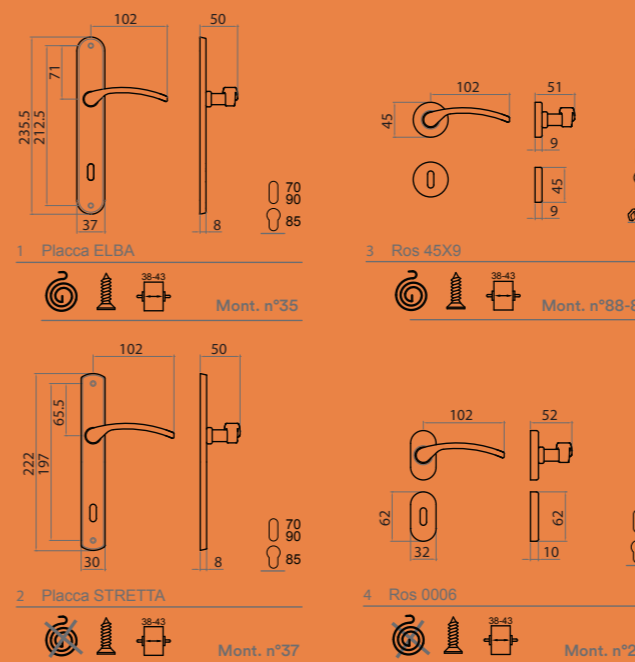

Per istruzioni di montaggio scansiona QR code, seleziona il numero di riferimento e segui le istruzioni.  
For assembly instructions scan the QR code, select the relevant assembly number and follow the instructions.

# ELITE



OBR OLV OLD OLV



OLV OLV

	OBR	OLV	OLD	Conf. Pz.
1 Q8 R Guarnitura Q8 ros. senza bocc. Lever handle 8mm on rose	55194280000 61,00	55194280001 56,10	55194280028 56,10	1
1 Q8 RB Guarnitura Q8 ros./bocc. patent Lever handle 8mm on rose key hole escutcheon	55194281000 70,08	55194281001 63,98	55194281028 63,98	1
1 Q8 RBY Guarnitura Q8 ros./bocc. yale Lever handle 8mm on rose - cyl. hole escutcheon	55194285000 70,08	55194285001 63,98	55194285028 63,98	1
1 Q8 RBWC Guarnitura Q8 ros./bocc. Wc Lever handle 8mm on rose wc hole escutcheon	55194288000 79,78	55194288001 73,98	55194288028 73,98	1
2 Q8 ROC Guarnitura Q8 ros.ovale senza bocc. Lever handle 8mm on oval rose	55194220500 66,65	55194220501 61,75	55194220528 61,75	1
2 Q8 RBOC Guarnitura Q8 ros/boc. ovale patent Lever handle 8mm on oval rose key hole escutcheon	55194221500 76,48	55194221501 70,38	55194221528 70,38	1
2 Q8 RBOYC Guarnitura Q8 ros/boc. ovale Yale Lever handle 8mm on oval rose - cyl. hole escutcheon	55194225500 76,48	55194225501 70,38	55194225528 70,38	1
3 Q8 RVV Guarnitura Q8 ros. senza bocc. Lever handle 8mm on rose	55194250000 61,00	55194250001 56,10	55194250028 56,10	1
3 Q8 RBVV Guarnitura Q8 ros./bocc. patent Lever handle 8mm on rose key hole escutcheon	55194251000 70,08	55194251001 63,98	55194251028 63,98	1
4 MART Martellina Q7 window handle	55194500000 44,48	55194500001 39,58	55194500028 39,58	2
5 DK X 40 Martellina DK Q7 x 40 window handle DK x 40 mm	55194557000 45,01	55194557001 41,96	55194557028 41,96	2
5 DK X 40 C/BUSS. Martellina DK Q7 x 40 con bussole D. 9,5 window handle DK x 40mm with pins D.9,5	55194558000 45,01	55194558001 41,96	55194558028 41,96	2

### PORTA

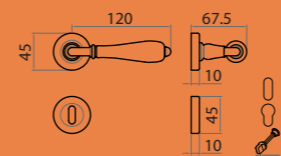

1 Ros 45X9  
Mont. n°88-89

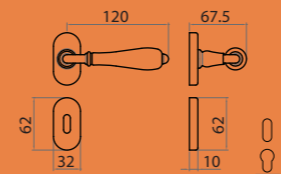

2 Ros 0006  
Mont. n°25

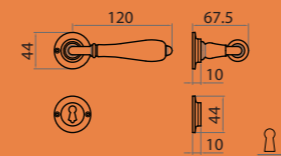

3 Ros 45x10 V.V.  
Mont. n°107

### FINESTRA

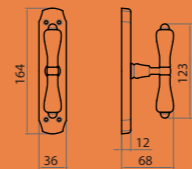

4  
Mont. n°147

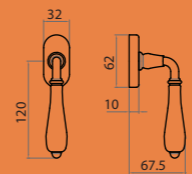

5  
Mont. n°4



Per istruzioni di montaggio scansiona QR code, seleziona il numero di riferimento e segui le istruzioni.  
For assembly instructions scan the QR code, select the relevant assembly number and follow the instructions.

# GINEVRA

DESIGN FABRIZIO BIANCHETTI



OCL-OCS

OLS

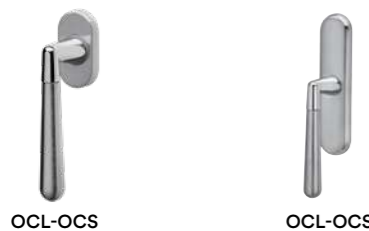

OCL-OCS

OCL-OCS

	OLS	OCL/OCS	Conf. Pz.
1 Q8R Guarnitura Q8 ros. senza bocc. Lever handle 8mm on rose	55846230302 59,82	5584623030703 57,44	1
1 Q8 RB Guarnitura Q8 ros./bocc. patent Lever handle 8mm on rose key hole escutcheon	55846231302 64,43	5584623130703 62,50	1
1 Q8 RBY Guarnitura Q8 ros./bocc. yale Lever handle 8mm on rose - cyl. hole escutcheon	55846235302 64,43	5584623530703 62,50	1
1 Q8 RBWC Guarnitura Q8 ros./bocc. Wc Lever handle 8mm on rose wc hole escutcheon	55846238302 73,51	5584623830703 75,44	1
2 Q8 ROC Guarnitura Q8 ros.ovale senza bocc molla Lever handle 8mm on springloaded oval rose	55846220502 71,13	5584622050703 63,24	1
2 Q8 RBOC Guarnitura Q8 ros/boc. ovale patent molla Lever handle 8mm on springloaded oval rose key hole escutcheon	55846221502 97,91	5584622150703 68,75	1
2 Q8 RBOYC Guarnitura Q8 ros/boc. ovale yale molla Lever handle 8mm on oval rose - cyl. hole escutcheon	55846225502 97,91	5584622550703 68,75	1
3 EZ IM Cremonese gioco EZ imp. maniglia Mechanism for window handle spindle 7 mm	55846456002 40,77	5584645600703 38,54	2
3 EZQ7 IM Cremonese gioco EZ + Q7 imp. maniglia Mechanism for window handle spindle 7 mm	55846457002 41,37	5584645700703 39,13	2
3 MART IM Martellina Q7 imp. Maniglia lever window handle	55846550002 40,77	5584655000703 38,54	2
4 DK x 40-35 Martellina DK Q7 x 40 window handle DK x 40 mm	55846557002 40,77	5584655700703 31,55	2
4 DK x 40-35 C/BUSS. Martellina DK Q7 x 40 con bussole D. 9,5 window handle DK x 40mm with pins D.9,5	55846558002 40,77	5584655800703 31,55	2

### PORTA

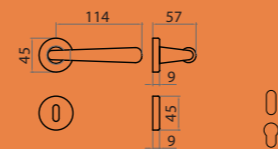

1 Ros 45x9  

 Mont. n°88-89

### FINESTRA

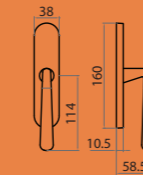

3  

 Mont. n°140-141

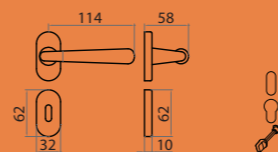

2 Ros 0006  

 Mont. n°25

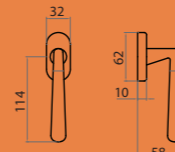

4  

 Mont. n°8



Per istruzioni di montaggio scansiona QR code, seleziona il numero di riferimento e segui le istruzioni.  
 For assembly instructions scan the QR code, select the relevant assembly number and follow the instructions.

# GOLF



OCS



OCL



G-PLUS



OLV



OLV

	OLV	OCS	OCL	Conf. Pz.
1 Q8 R Guarnitura Q8 ros. senza bocc. Lever handle 8mm on rose	55146280001 88,01	55146280003 86,01	55146280050 94,01	1
1 Q8 RB Guarnitura Q8 ros./bocc. patent Lever handle 8mm on rose key hole escutcheon	55146281001 116,93	55146281003 114,43	55146281007 124,43	1
1 Q8 RBY Guarnitura Q8 ros./bocc. yale Lever handle 8mm on rose - cyl. hole escutcheon	55146285001 116,93	55146285003 114,43	55146285007 124,43	1
1 Q8 RBWC Guarnitura Q8 ros./bocc. Wc Lever handle 8mm on rose wc hole escutcheon	55146288001 128,93	55146288003 124,43	55146288007 136,43	1
2 Q8 ROC Guarnitura Q8 ros.ovale senza bocc molla Lever handle 8mm on springloaded oval rose	55146220501 96,49	55146220503 94,49	55146220507 102,49	1
2 Q8 RBOC Guarnitura Q8 ros/boc. ovale patent molla Lever handle 8mm on springloaded oval rose key hole escutcheon	55146221501 128,38	55146221503 125,88	55146221507 135,88	1
2 Q8 RBOYC Guarnitura Q8 ros/boc. ovale yale molla Lever handle 8mm on oval rose - cyl. hole escutcheon	55146225501 128,38	55146225503 125,88	55146225507 135,88	1
3 EZ IM Cremonese gioco EZ imp. maniglia Mechanism for window handle spindle 7 mm	55146456001 87,41	55146456003 85,41	55146456007 93,41	2
3 EZQ7 IM Cremonese gioco EZ + Q7 imp. maniglia Mechanism for window handle spindle 7 mm	55146457001 88,01	55146457003 86,01	55146457007 94,01	2
3 MART IM Martellina Q7 imp. Maniglia lever window handle	55146550001 87,41	55146550003 85,41	55146550007 93,41	2
4 DK X 40 Martellina DK Q7 x 40 window handle DK x 40 mm	55146557001 86,66	55146557003 85,41	55146557007 90,41	2

### PORTA

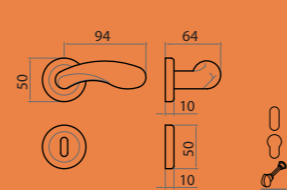

Ros GOLF



Mont. n°106-108

### FINESTRA

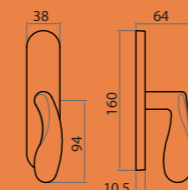

3



Mont. n°140-141

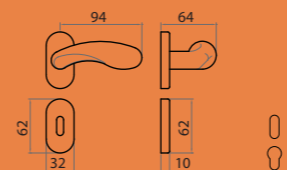

Ros 0006

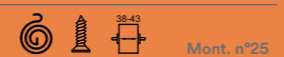

Mont. n°25

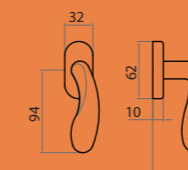

4



Mont. n°4



Per istruzioni di montaggio  
scansiona QR code,  
seleziona il numero di  
riferimento e segui le  
istruzioni.  
For assembly instructions  
scan the QR code, select the  
relevant assembly number  
and follow the instructions.

# LADY

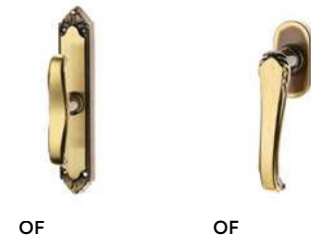

OF

ON

		OF	Conf. Pz.
1	Q8 P90 Guarnitura Q8 placca patent 90 Lever handle 8mm on key plate 90	44394089006 32,88	4
1	Q8 P70 Guarnitura Q8 placca patent 70 Lever handle 8mm on key plate 70	44394087006 32,88	4
1	Q8 PY85 Guarnitura Q8 placca yale 85 Lever handle 8mm on cyl. plate 85	44394088506 32,88	4
2	GZ Cremonese gioco GZ Mechanism for window handle spindle 7 mm	44394401006 21,43	6
2	GZP Cremonese gioco GZ + PERNI Mechanism for window handle spindle 7 mm	44394402006 22,17	6
2	GZQ7 Cremonese gioco GZ + Q7 Mechanism for window handle spindle 7 mm	44394403006 22,17	6
2	MART Martellina Q7 window handle	44394500006 20,53	6
3	DK x 40 Martellina DK Q7 x 40 window handle DK x 40 mm	44394555006 21,43	2

PORTA

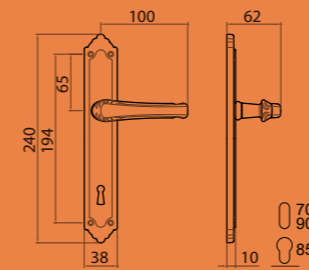

1 Placca LADY  

 Mont. n°41

FINESTRA

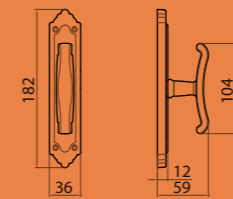

2  

 Mont. n°147

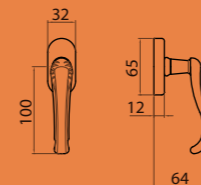

3  

 Mont. n°4



Per istruzioni di montaggio  
scansiona QR code,  
seleziona il numero di  
riferimento e segui le  
istruzioni.  
For assembly instructions  
scan the QR code, select the  
relevant assembly number  
and follow the instructions.

# LINEA

DESIGN DILETTA CAUSIN



ZCL



ZNO



TITANIUM

	ZCL	ZNO	TITANIUM	Conf. Pz.
1 Q8 R Guarnitura Q8 ros. senza bocc. Lever handle 8mm on rose	66540210407 73,77	66540210416 63,97	66540210454 73,77	1
1 Q8 RB Guarnitura Q8 ros./bocc. patent Lever handle 8mm on rose key hole escutcheon	66540211407 83,94	66540211416 71,69	66540211454 83,94	1
1 Q8 RBY Guarnitura Q8 ros./bocc. yale Lever handle 8mm on rose - cyl. hole escutcheon	66540215407 83,94	66540215416 71,69	66540215454 83,94	1

### PORTA

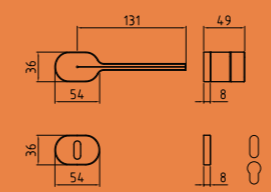

Per istruzioni di montaggio  
scansiona QR code,  
seleziona il numero di  
riferimento e segui le  
istruzioni.  
For assembly instructions  
scan the QR code, select the  
relevant assembly number  
and follow the instructions.

# MILENA



	OLV	OCS	OGV	OCL	OS	Cont. Pz.
1 Q8 P90 Guarnitura Q8 placca patent 90 Lever handle 8mm on key plate 90	55744089001 67,86	55744089003 64,11	55744089004 77,01	55744089007 79,11	55744089008 67,86	1
1 Q8 P70 Guarnitura Q8 placca patent 70 Lever handle 8mm on key plate 70	55744087001 67,86	55744087003 64,11	55744087004 77,01	55744087007 79,11	55744087008 67,86	1
1 Q8 PY85 Guarnitura Q8 placca yale 85 Lever handle 8mm on cyl. plate 85	55744088501 67,86	55744088503 64,11	55744088504 77,01	55744088507 79,11	55744088508 67,86	1
2 Q8 P9ORS Guarnitura Q8 placca stretta pat 90 Lever handle 8mm on reduced key plate 90	55744051001 61,40	55744051003 57,65	55744051004 70,55	55744051007 72,65	55744051008 61,40	1
2 Q8 P7ORS Guarnitura Q8 placca stretta pat 70 Lever handle 8mm on reduced key plate 70	55744057001 61,40	55744057003 57,65	55744057004 70,55	55744057007 72,65	55744057008 61,40	1
2 Q8 PY85RS Guarnitura Q8 placca stretta yale 85 Lever handle 8mm on reduced cyl. plate 85	55744055001 61,40	55744055003 57,65	55744055004 70,55	55744055007 72,65	55744055008 61,40	1
3 Q8 R Guarnitura Q8 ros. senza bocc. Lever handle 8mm on rose	55744280501 44,86	55744280503 42,86	55744280504 49,76	55744280507 50,86	55744280508 44,86	1
3 Q8 RB Guarnitura Q8 ros./bocc. patent Lever handle 8mm on rose key hole escutcheon	55744281501 36,11	55744281503 34,11	55744281504 42,71	55744281507 44,11	55744281508 36,61	1
3 Q8 RBY Guarnitura Q8 ros./bocc. yale Lever handle 8mm on rose - cyl. hole escutcheon	55744285501 36,11	55744285503 34,11	55744285504 42,71	55744285507 44,11	55744285508 36,61	1
3 Q8 RBWC Guarnitura Q8 ros./bocc. Wc Lever handle 8mm on rose wc hole escutcheon	55744288001 48,61	55744288003 44,11	55744288004 54,41	55744288007 56,11	55744288008 48,61	1
4 Q8 ROC Guarnitura Q8 ros.ovale senza bocc. Lever handle 8mm on oval rose	55744220501 48,87	55744220503 46,87	55744220504 53,77	55744220507 54,87	55744220508 48,87	1
4 Q8 RBOC Guarnitura Q8 ros/boc. ovale patent Lever handle 8mm on oval rose key hole escutcheon	55744221501 59,44	55744221503 56,94	55744221504 65,54	55744221507 66,94	55744221508 59,44	1
4 Q8 RBOYC Guarnitura Q8 ros/boc. ovale Yale Lever handle 8mm on oval rose - cyl. hole escutcheon	55744225501 59,44	55744225503 56,94	55744225504 65,54	55744225507 66,94	55744225508 59,44	1
5 EZ Cremonese gioco EZ Mechanism for window handle spindle 7 mm	55744406001 29,86	55744406003 27,86	55744406004 34,76	55744406007 35,86	55744406008 29,86	2
5 EZQ7 Cremonese gioco EZ + Q7 Mechanism for window handle spindle 7 mm	55744407001 30,60	55744407003 28,60	55744407004 35,50	55744407007 36,60	55744407008 30,60	2
5 MART Martellina Q7 window handle	55744500001 25,48	55744500003 23,48	55744500004 30,38	55744500007 31,48	55744500008 25,48	2
6 DK x 40-35 Martellina DK Q7 x 40-35 window handle DK x 40-35mm	55744577001 24,94	55744577003 23,69	55744577004 27,99	55744577007 28,69	55744577008 24,94	2
6 DK x 40-35 C/BUSS Martellina DK Q7 x 40-35 con bussole window handle DK x 40-35 mm with pins D,9,5	55744578001 21,56	55744578003 20,31	55744578004 24,61	55744578007 25,31	55744578008 21,56	2

### PORTA

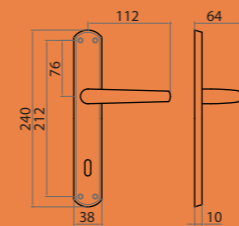

1 Placca MILENA Mont. n°38



### FINESTRA

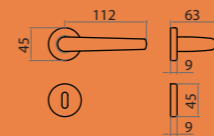

3 Ros 45X9 Mont. n°88-89

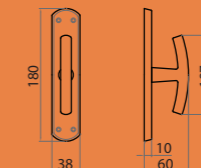

5 Mont. n°145-146

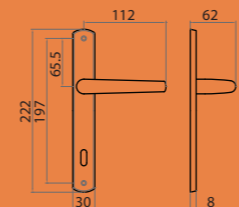

2 Placca STRETTA Mont. n°37

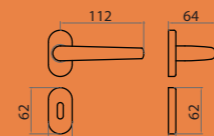

4 Ros 0006 Mont. n°25

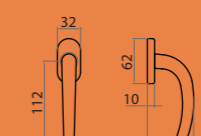

6 DK-2P Mont. n°8



Per istruzioni di montaggio scansiona QR code, seleziona il numero di riferimento e segui le istruzioni.  
For assembly instructions scan the QR code, select the relevant assembly number and follow the instructions.



# NOVECENTO



	OBR	OLV	OCL	OLD	OFA	Conf. Pz.
1 Q8 R Guarnitura Q8 ros. senza bocc. Lever handle 8mm on rose	55196280000 56,09	55196280001 51,19	55196280007 57,19	55196280028 51,19	55196280029 65,19	1
1 Q8 RB Guarnitura Q8 ros./bocc. patent Lever handle 8mm on rose key hole escutcheon	55196281000 64,72 ⚡	55196281001 58,92 ⚡	55196281007 66,42	55196281028 58,92 ⚡	55196281029 76,42	1
1 Q8 RBY Guarnitura Q8 ros./bocc. yale Lever handle 8mm on rose - cyl. hole escutcheon	55196285000 64,72 ⚡	55196285001 58,92 ⚡	55196285007 66,42	55196285028 58,92 ⚡	55196285029 76,42	1
1 Q8 RBWC Guarnitura Q8 ros./bocc. Wc Lever handle 8mm on rose wc hole escutcheon	55196288000 74,72 ⚡	55196288001 68,92 ⚡	55196288007 76,42	55196288028 68,92 ⚡	55196288029 88,42	1
2 Q8 RVV Guarnitura Q8 ros. senza bocc. Lever handle 8mm on rose	55196250000 56,09	55196250001 51,19	55196250007 57,19	55196250028 51,19	55196250029 65,19	1
2 Q8 RBVV Guarnitura Q8 ros./bocc. patent Lever handle 8mm on rose key hole escutcheon	55196251000 64,72	55196251001 58,92	55196251007 66,42	55196251028 58,92	55196251029 76,42	1
3 Q8 ROC Guarnitura Q8 ros.ovale senza bocc. Lever handle 8mm on oval rose	55196220500 61,30	55196220501 56,40	55196220507 62,40	55196220528 56,40	55196220529 70,40	1
3 Q8 RBOC Guarnitura Q8 ros/boc. ovale patent Lever handle 8mm on oval rose key hole escutcheon	55196221500 70,98	55196221501 64,88	55196221507 72,38	55196221528 64,88	55196221529 82,38	1
3 Q8 RBOYC Guarnitura Q8 ros/boc. ovale Yale Lever handle 8mm on oval rose - cyl. hole escutcheon	55196225500 70,98	55196225501 64,88	55196225507 72,38	55196225528 64,88	55196225529 82,38	1
4 MART Martellina Q7 window handle	55196500000 39,42	55196500001 34,52	55196500007 40,52	55196500028 34,52	55196500029 48,52	2
5 DK x 40-35 Martellina DK Q7 x 40-35 window handle DK x 40-35mm	55196577000 39,95	55196577001 36,90	55196577007 40,65	55196577028 36,90	55196577029 45,65	2
5 DK x 40-35 C/BUSS Martellina DK Q7 x 40-35 con bussole window handle DK x 40-35 mm with pins D.9,5	55196578000 39,95	55196578001 36,90	55196578007 40,65	55196578028 36,90	55196578029 45,65	2

⚡ Servizio G48: Articolo a magazzino e disponibile entro 48 dall'elaborazione dell'ordine. In base a disponibilita' e condizioni di vendita.  
G48 service: Item in stock and available within 48 hours of order processing. Based on availability and sales conditions.

### PORTA

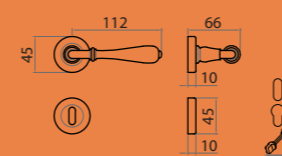

1 Ros 45X9  
Mont. n°88-89

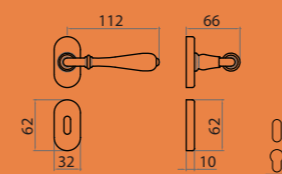

2 Ros 0006  
Mont. n°25

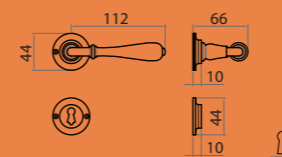

3 Ros 45x10 V.V.  
Mont. n°107

### FINESTRA

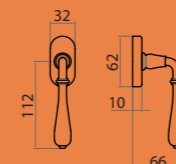

4  
Mont. n°8

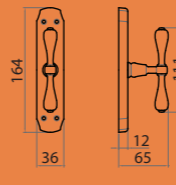

5  
Mont. n°147



Per istruzioni di montaggio scansiona QR code, seleziona il numero di riferimento e segui le istruzioni.  
For assembly instructions scan the QR code, select the relevant assembly number and follow the instructions.

# PIGNA



	OLV	OCS	OCL	Conf. Pz.
1 Q8 R50 Guarnitura Q8 ros.50x7 senza bocc. Lever handle 8mm on rose 50x7mm	55442250501 63,31	55442250503 61,31	55442250507 69,31	1
1 Q8 RB50 Guarnitura Q8 ros./bocc. 50x7 patent Lever handle 8mm on rose 50X7 key hole escutcheon	55442251501 72,73	55442251503 70,23	55442251507 80,23	1
1 Q8 RBY50 Guarnitura Q8 ros./bocc. yale Lever handle 8mm on rose - cyl. hole escutcheon	55442255501 72,73	55442255503 70,23	55442255507 80,23	1
1 Q8 RBWC Guarnitura Q8 ros./bocc. Wc Lever handle 8mm on rose wc hole escutcheon	55442258501 84,73	55442258503 80,23	55442258507 92,23	1
2 Q8 ROC Guarnitura Q8 ros.ovale senza bocc molla Lever handle 8mm on springloaded oval rose	55442220501 69,41	55442220503 67,41	55442220507 75,41	1
2 Q8 RBOC Guarnitura Q8 ros/boc. ovale patent molla Lever handle 8mm on springloaded oval rose key hole escutcheon	55442221501 79,73	55442221503 77,23	55442221507 87,23	1
2 Q8 RBOYC Guarnitura Q8 ros/boc. ovale yale molla Lever handle 8mm on oval rose - cyl. hole escutcheon	55442225501 79,73	55442225503 77,23	55442225507 87,23	1
3 EZ IM Cremonese gioco EZ imp. maniglia Mechanism for window handle spindle 7 mm	55442456001 88,01	55442456003 86,01	55442456007 94,01	2
3 EZQ7 IM Cremonese gioco EZ + Q7 imp. maniglia Mechanism for window handle spindle 7 mm	55442457001 88,60	55442457003 86,60	55442457007 94,60	2
3 MART IM Martellina Q7 imp. Maniglia Lever window handle	55442550001 88,01	55442550003 86,01	55442550007 94,01	2
4 DK X 40 Martellina DK Q7 x 40 window handle DK x 40 mm	55442557001 36,07	55442557003 34,82	55442557007 39,82	2
4 DK X 40 C/BUSS. Martellina DK Q7 x 40 con bussole D. 9,5 window handle DK x 40mm with pins D.9,5	55442558001 36,07	55442558003 34,82	55442558007 39,82	2

### PORTA

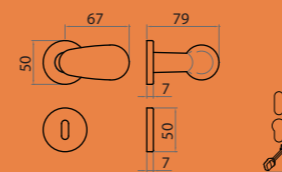

1 Ros 0005  
Mont. n°93-94

### FINESTRA

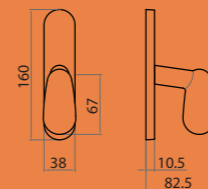

3  
Mont. n°140-141

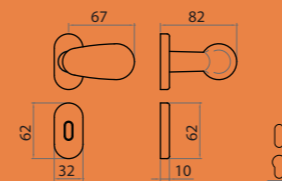

2 Ros 0006  
Mont. n°25

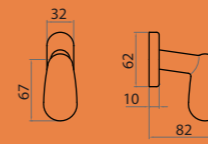

4  
Mont. n°4



Per istruzioni di montaggio scansiona QR code, seleziona il numero di riferimento e segui le istruzioni.  
For assembly instructions scan the QR code, select the relevant assembly number and follow the instructions.

# R5200

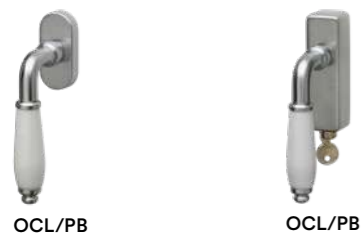

	OCS-PB	OCL-PB	OFA-NO	ONL-NO	Conf. Pz.
1 Q8 R Guarnitura Q8 ros. senza bocc. Lever handle 8mm on rose	R5200000505C360 75,22	R5200000505C760 83,22	R5200000505UF60 91,22	R5200000505UN60 91,22	1
1 Q8 RB BB Guarnitura Q8 ros./bocc. BB Lever handle 8mm on rose - key escutcheon	R5200000512C360 80,28	R5200000512C760 90,28	R5200000512UF60 100,28	R5200000512UN60 100,28	1
1 Q8 RBY Guarnitura Q8 ros./bocc. yale Lever handle 8mm on rose - cyl. hole escutcheon	R5200000550C360 80,28	R5200000550C760 90,28	R5200000550UF60 100,28	R5200000550UN60 100,28	1
1 Q8 RBWC Guarnitura Q8 ros./bocc. Wc Lever handle 8mm on rose - wc 6mm function	R5200000588C360 90,28	R5200000588C760 102,28	R5200000588UF60 114,28	R5200000588UN60 114,28	1
2 DK x 35 VM C/BUSS. Martellina DK Q7x35 c/bus D.9,5 mm viti metriche window handle DK x 35 mm with pins D.9.5 metric screws	R5200000480C390 41,37	R5200000480C790 46,37	R5200000480UF90 51,37	R5200000480UN90 51,37	1
3 DK x 42 C/CHIAVE VM C/BUSS. Martellina con chiave DK Q7x42 c/bus D.9,5 mm viti metriche window handle DK x 42mm with key / pins D.9.5 with screws	R520000A484C390 119,78	R520000A484C790 124,78	R520000A484UF90 129,78	R520000A484UN90 129,78	1

### PORTA

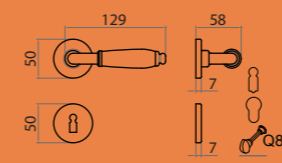

1 Ros 0005  
Mont. n°93-94

### FINESTRA

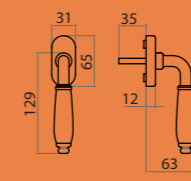

2 Gioco in ferro  
Mont. n°4

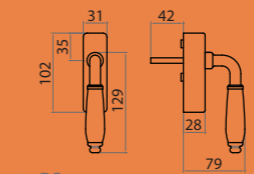

3 RG  
Mont. n°11



Per istruzioni di montaggio  
scansiona QR code,  
seleziona il numero di  
riferimento e segui le  
istruzioni.  
For assembly instructions  
scan the QR code, select the  
relevant assembly number  
and follow the instructions.

# R716



OFA OLD OANT



OANT OANT

	OLD	OFA	OANT	Conf. Pz.
1 Q8 R Guarnitura Q8 ros. senza bocc. Lever handle 8mm on rose	R07160005052860	R07160005052960	R07160005054260	1
1 Q8 RB Guarnitura Q8 ros./bocc. BB Lever handle 8mm on rose - key escutcheon	R07160005122860	R07160005122960	R07160005124260	1
1 Q8 RBY Guarnitura Q8 ros./bocc. yale Lever handle 8mm on rose - cyl. hole escutcheon	R07160005502860	R07160005502960	R07160005504260	1
1 Q8 RBWC Guarnitura Q8 ros./bocc. Wc Lever handle 8mm on rose - wc 6mm function	R07160005802860	R07160005802960	R07160005804260	1
2 DK x 35 C/BUSS. Martellina DK Q7x35 c/bus D.9,5 mm viti metriche window handle DK x 35 mm with pins D.9.5 metric screws	R07160004802890	R07160004802990	R07160004804290	1
3 DK x 42 C/CHIAVE C/BUSS. Martellina con chiave DK Q7x42 c/bus D.9,5 mm viti metriche window handle DK x 42mm with key / pins D.9.5 with screws	R071600A4842890	R071600A4842990	R071600A4844290	1

PORTA

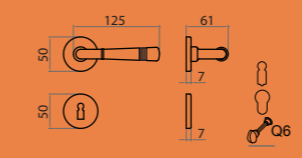

- 1 Ros 0005  

 Mont. n°93-94

FINESTRA

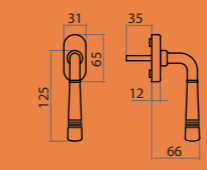

- 2 Gioco in ferro  

 Mont. n°4

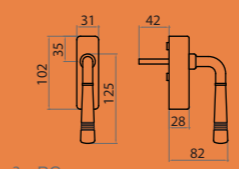

- 3 RG  

 Mont. n°11



Per istruzioni di montaggio scansiona QR code, seleziona il numero di riferimento e segui le istruzioni.  
 For assembly instructions scan the QR code, select the relevant assembly number and follow the instructions.

# R716



OCL-M4      OLV-M1      ONS-M9



OCL-M4      OCL-M4

	OLV	OCL	ONS	Conf. Pz.
1 Q8 R Guarnitura Q8 ros. senza bocc. Lever handle 8mm on rose	R07160005050160	R07160005050760	R07160005052760	1
1 Q8 RB Guarnitura Q8 ros./bocc. BB Lever handle 8mm on rose - key escutcheon	R07160005120160	R07160005120760	R07160005122760	1
1 Q8 RBY Guarnitura Q8 ros./bocc. yale Lever handle 8mm on rose - cyl. hole escutcheon	R07160005500160	R07160005500760	R07160005502760	1
1 Q8 RBWC Guarnitura Q8 ros./bocc. Wc Lever handle 8mm on rose - wc 6mm function	R07160005800160	R07160005800760	R07160005802760	1
2 DK x 35 C/BUSS. Martellina DK Q7x35 c/bus D.9,5 mm viti metriche window handle DK x 35 mm with pins D.9.5 metric screws	R07160004800190	R07160004800790	R07160004802790	1
3 DK x 42 C/CHIAVE C/BUSS. Martellina con chiave DK Q7x42 c/bus D.9,5 mm viti metriche window handle DK x 42mm with key / pins D.9.5 with screws	R071600A4840190	R071600A4840790	R071600A4842790	1

PORTA

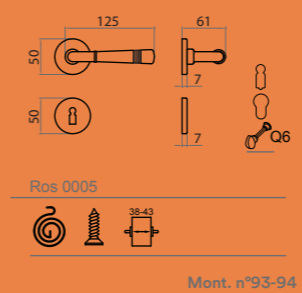

FINESTRA

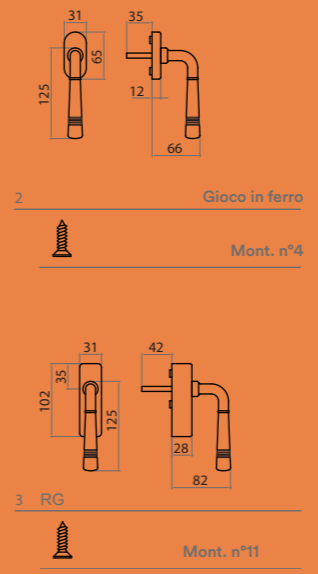

Per istruzioni di montaggio scansiona QR code, seleziona il numero di riferimento e segui le istruzioni.  
For assembly instructions scan the QR code, select the relevant assembly number and follow the instructions.

# R771

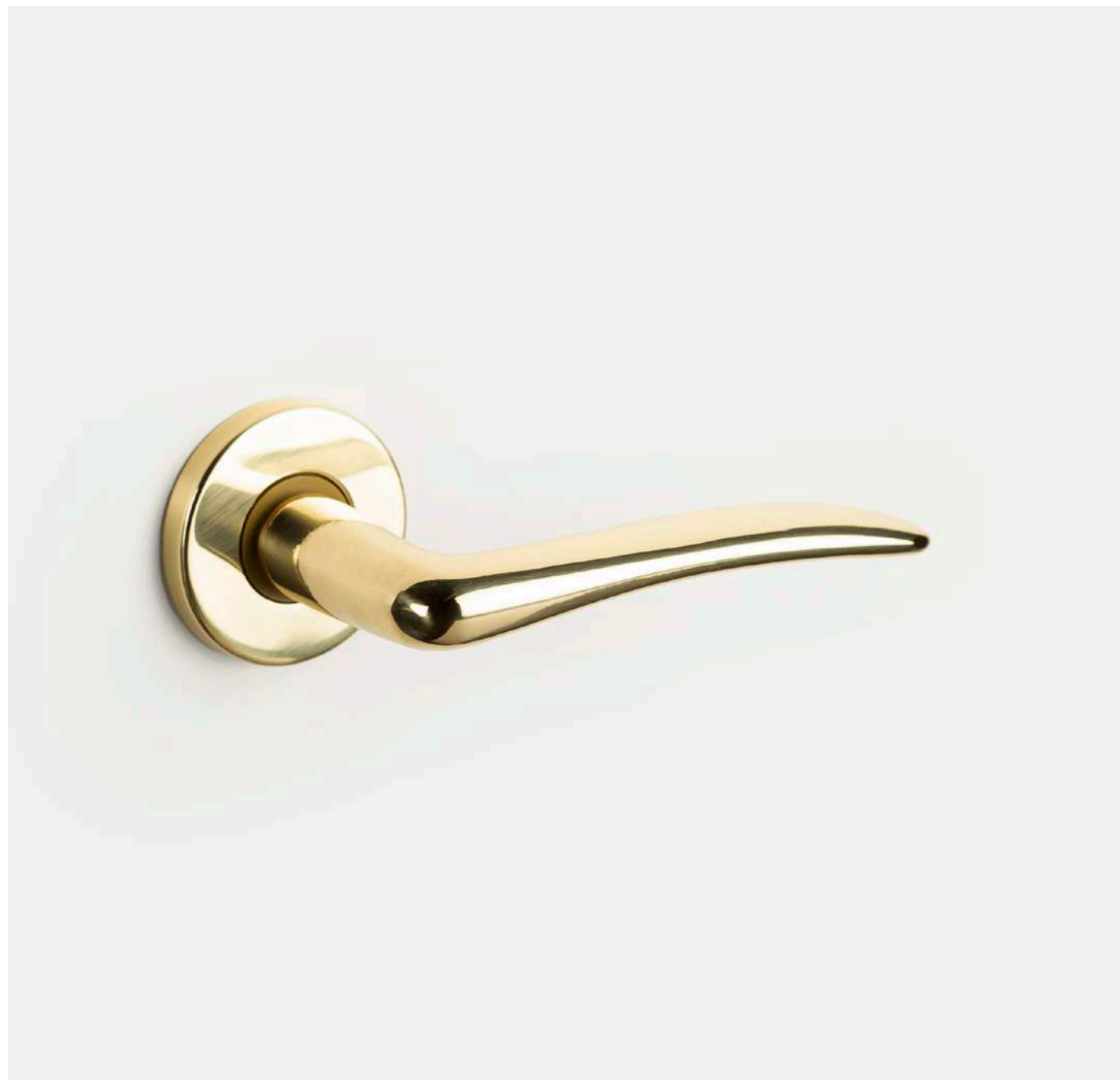

	OLV	OCS	OCL	ONS	Conf. Pz.
1 Q8 R Guarnitura Q8 ros. senza bocc. Lever handle 8mm on rose	R07710005050160 40,46	R07710005050360 38,46	R07710005050760 46,46	R07710005052760 54,46	1
1 Q8 RB Guarnitura Q8 ros./bocc. BB Lever handle 8mm on rose - key escutcheon	R07710005120160 45,88	R07710005120360 43,38	R07710005120760 53,38	R07710005122760 63,38	1
1 Q8 RBY Guarnitura Q8 ros./bocc. yale Lever handle 8mm on rose - cyl. hole escutcheon	R07710005500160 45,88	R07710005500360 43,38	R07710005500760 53,38	R07710005502760 63,38	1
1 Q8 RBWC Guarnitura Q8 ros./bocc. Wc Lever handle 8mm on rose - wc 6mm function	R07710005800160 57,88	R07710005800360 53,38	R07710005800760 65,38	R07710005802760 77,38	1
2 DK x 35 C/BUSS. Martellina DK Q7x35 c/bussole D.9,5 mm viti metriche window handle DK x 35 mm with pins D.9.5 metric screws	R07710004800190 28,18	R07710004800390 26,93	R07710004800790 31,93	R07710004802790 36,93	1
3 DK x 42 C/CHIAVE C/BUSS. Martellina con chiave DK Q7x42 c/bus D.9,5 mm viti metriche window handle DK x 42mm with key / pins D.9.5 with screws	R077100A4840190 106,45	R077100A4840390 105,20	R077100A4840790 110,20	R077100A4842790 115,20	1

### PORTA

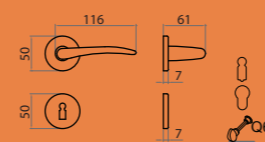

- 1 Ros 0005  

 Mont. n°93-94

### FINESTRA

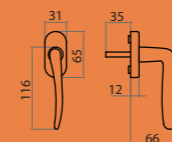

- 2 Gioco in ferro  

 Mont. n°4

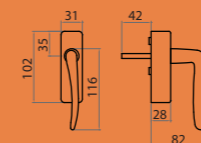

- 3 RG  

 Mont. n°11



Per istruzioni di montaggio  
scansiona QR code,  
seleziona il numero di  
riferimento e segui le  
istruzioni.  
For assembly instructions  
scan the QR code, select the  
relevant assembly number  
and follow the instructions.

# R775



	ZCL	GCTOL	ZCS	ZNS	Conf. Pz.
1 Q8 R Guarnitura Q8 ros. senza bocc. Lever handle 8mm on rose	R07750005050760 58,22	R07750005051260 52,22	R07750005051360 50,22	R07750005052760 66,22	1
1 Q8 RB Guarnitura Q8 ros./bocc. BB Lever handle 8mm on rose - key escutcheon	R07750005120760 65,43	R07750005121260 57,93	R07750005121360 55,43	R07750005122760 75,43	1
1 Q8 RB Guarnitura Q8 ros./bocc. patent Lever handle 8mm on rose - key escutcheon	R07750005100760 65,43	R07750005101260 57,93	R07750005101360 55,43	R07750005102760 75,43	1
1 Q8 RBY Guarnitura Q8 ros./bocc. yale Lever handle 8mm on rose - cyl. hole escutcheon	R07750005500760 65,43	R07750005501260 57,93	R07750005501360 55,43	R07750005502760 75,43	1
1 Q8 RBWC Guarnitura Q8 ros./bocc. Wc Lever handle 8mm on rose - wc 6mm function	R07750005800760 77,43	R07750005801260 69,93	R07750005801360 65,43	R07750005802760 89,43	1
2 DK x 35 C/BUSS. Martellina DK Q7x35 c/bussole D.9,5 mm viti metriche window handle DK x 35 mm with pins D.9.5 metric screws	R07750004800790 36,10	R07750004801290 32,35	R07750004801390 31,10	R07750004802790 41,10	1
3 DK x 42 C/CHIAVE C/BUSS. Martellina con chiave DK Q7x42 c/bussole D.9,5 mm viti metriche window handle DK x 42mm with key / pins D.9.5 with screws	R077500A4840790 114,37	R077500A4841290 110,62	R077500A4841390 109,37	R077500A4842790 119,37	1

### PORTA

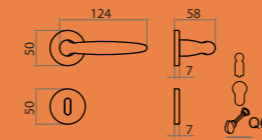

Mont. n°93-94

### FINESTRA

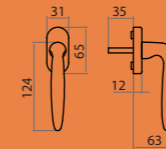

Mont. n°4

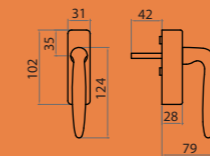

Mont. n°11



Per istruzioni di montaggio  
scansiona QR code,  
seleziona il numero di  
riferimento e segui le  
istruzioni.  
For assembly instructions  
scan the QR code, select the  
relevant assembly number  
and follow the instructions.

# R901



	OLV	OCL	OLD	OFA	OANT	Conf. Pz.
1 Q8 R Guarnitura Q8 ros. senza bocc. Lever handle 8mm on rose	R09010005050160 57,88	R09010005050760 63,88	R09010005052860 57,88	R09010005052960 71,88	R09010005054260 71,88	1
1 Q8 RB BB Guarnitura Q8 ros./bocc. BB Lever handle 8mm on rose - key escutcheon	R09010005120160 61,16	R09010005120760 68,66	R09010005122860 61,16	R09010005122960 78,66	R09010005124260 78,66	1
1 Q8 RBY Guarnitura Q8 ros./bocc. yale Lever handle 8mm on rose - cyl. hole escutcheon	R09010005500160 61,16	R09010005500760 68,66	R09010005502860 61,16	R09010005502960 78,66	R09010005504260 78,66	1
1 Q8 RBWC Guarnitura Q8 ros./bocc. Wc Lever handle 8mm on rose - wc 6mm function	R09010005800160 71,16	R09010005800760 78,66	R09010005802860 71,16	R09010005802960 94,66	R09010005804260 94,66	1
2 DK x 35 VM C/BUSS. Martellina DK Q7x35 c/bus D.9,5 mm viti metriche window handle DK x 35 mm with pins D.9.5 metric screws	R09010004800190 43,30	R09010004800790 47,05	R09010004802890 43,30	R09010004802990 52,05	R09010004804290 52,05	1
3 DK x 42 C/CHIAVE VM C/BUSS. Martellina con chiave DK Q7x42 c/bus D.9,5 mm viti metriche window handle DK x 42mm with key / pins D.9.5 with screws	R090100A4840190 121,87	R090100A4840790 125,62	R090100A4842890 121,87	R090100A4842990 130,62	R090100A4844290 130,62	1

### PORTA

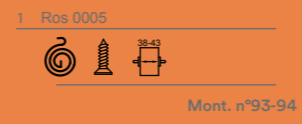
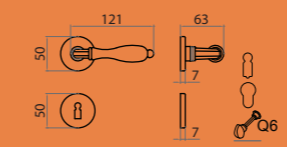

Mont. n°93-94

### FINESTRA

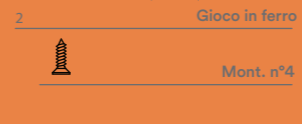
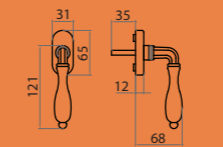

Mont. n°11

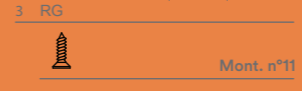
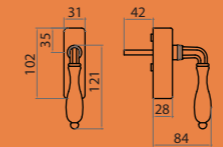

Mont. n°11



Per istruzioni di montaggio  
scansiona QR code,  
seleziona il numero di  
riferimento e segui le  
istruzioni.  
For assembly instructions  
scan the QR code, select the  
relevant assembly number  
and follow the instructions.



# R988



R0988

R988

Brass



ONL

OCL

OCL



OCL



OCL

Handles

R0988

R988

Ottone

Maniglie

	OCS	OCL	ONS	Conf. Pz.
1 Q8 RQ Guarnitura Q8 ros. senza bocc. Lever handle 8mm on rose	R09880544050360 105,42	R09880544050760 113,42	R09880544052760 121,42	1
1 Q8 RBQ Guarnitura Q8 ros./bocc. patent Lever handle 8mm on rose - key escutcheon with wooden screw	R09880544100360 121,05	R09880544100760 131,05	R09880544102760 141,05	1
1 Q8 RBQY Guarnitura Q8 ros./bocc. yale Lever handle 8mm on rose - cyl. hole escutcheon	R09880544500360 121,05	R09880544500760 131,05	R09880544502760 141,05	1
1 Q8 RBQWC Guarnitura Q8 ros./bocc. Wc Lever handle 8mm on rose wc hole escutcheon	R09880544800360 131,05	R09880544800760 143,05	R09880544802760 155,05	1
2 DK X 35 C/BUSS. Martellina DK Q7x35 c/bussole D.9,5 mm viti metriche window handle DK x 35 mm with pins D.9,5 metric screws	R098800C4800390 52,53	R098800C4800790 57,53	R098800C4802790 62,53	1
3 DK X 42 C/CHIAVE C/BUSS. Martellina con chiave DK Q7x42 c/bussole D.9,5 mm viti metriche window handle DK x 42mm with key / pins D.9,5 with screws	R098800A4840390 130,05	R098800A4840790 135,05	R098800A4842790 140,05	1

PORTA

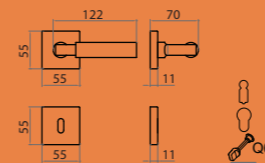

1 Ros 544  
Mont. n°68-69

FINESTRA

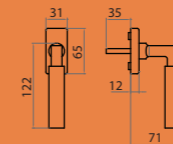

2 Gioco in ferro  
Mont. n°4

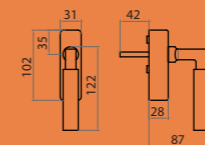

3 RG  
Mont. n°11



Per istruzioni di montaggio scansiona QR code, seleziona il numero di riferimento e segui le istruzioni.  
For assembly instructions scan the QR code, select the relevant assembly number and follow the instructions.

# R988



R0988

R988

Brass

Handles

	ONL	OCL-EB	ONL-EB	Conf. Pz.
1 Q8 RQ Guarnitura Q8 ros. senza bocc. Lever handle 8mm on rose	R09880544053060	R0988054405E760	R0988054405EN60	1
1 Q8 RBQ Guarnitura Q8 ros./bocc. patent Lever handle 8mm on rose - key escutcheon with wooden screw	R09880544103060	R0988054410E760	R0988054410EN60	1
1 Q8 RBQY Guarnitura Q8 ros./bocc. yale Lever handle 8mm on rose - cyl. hole escutcheon	R09880544503060	R0988054450E760	R0988054450EN60	1
1 Q8 RBQWC Guarnitura Q8 ros./bocc. Wc Lever handle 8mm on rose wc hole escutcheon	R09880544803060	R0988054480E760	R0988054480EN60	1
2 DK X 35 C/BUSS. Martellina DK Q7x35 c/bussole D.9,5 mm viti metriche window handle DK x 35 mm with pins D.9.5 metric screws	R098800C4803090	R098800C480E790	R098800C480EN90	1
3 DK X 42 C/CHIAVE C/BUSS. Martellina con chiave DK Q7x42 c/bussole D.9,5 mm viti metriche window handle DK x 42mm with key / pins D.9.5 with screws	R098800A4843090	R098800A484E790	R098800A484EN90	1

R0988

R988

Ottone

Maniglie

PORTA

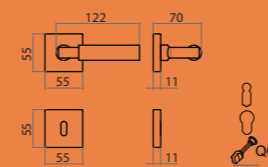

1 Ros 544  
Mont. n°68-69

FINESTRA

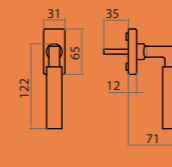

2 Gioco in ferro  
Mont. n°4

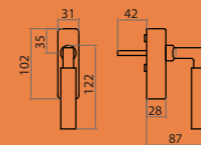

3 RG  
Mont. n°11



Per istruzioni di montaggio scansiona QR code, seleziona il numero di riferimento e segui le istruzioni.  
For assembly instructions scan the QR code, select the relevant assembly number and follow the instructions.

# TIROL



	OLV	OCS	OCL	Conf. Pz.
1 Q8 P90 Guarnitura Q8 placca patent 90 Lever handle 8mm on key plate 90	55452089001 54,79	55452089003 51,04	55452089007 66,04	1
1 Q8 P70 Guarnitura Q8 placca patent 70 Lever handle 8mm on key plate 70	55452087001 54,79	55452087003 51,04	55452087007 66,04	1
1 Q8 PY85 Guarnitura Q8 placca yale 85 Lever handle 8mm on cyl. plate 85	55452088501 54,79	55452088503 51,04	55452088507 66,04	1
2 Q8 P90RS Guarnitura Q8 placca stretta pat 90 Lever handle 8mm on reduced key plate 90	55452051001 60,00	55452051003 56,25	55452051007 71,25	1
2 Q8 P70RS Guarnitura Q8 placca stretta pat 70 Lever handle 8mm on reduced key plate 70	55452057001 60,00	55452057003 56,25	55452057007 71,25	1
2 Q8 PY85RS Guarnitura Q8 placca stretta yale 85 Lever handle 8mm on reduced cyl. plate 85	55452055001 60,00	55452055003 56,25	55452055007 71,25	1
3 Q8 R Guarnitura Q8 ros. senza bocc. Lever handle 8mm on rose	55452280001 41,58	55452280003 39,58	55452280007 47,58	1
3 Q8 RB Guarnitura Q8 ros./bocc. patent Lever handle 8mm on rose key hole escutcheon	55452281001 50,26	55452281003 47,76	55452281007 57,76	1
3 Q8 RBY Guarnitura Q8 ros./bocc. yale Lever handle 8mm on rose - cyl. hole escutcheon	55452285001 50,26	55452285003 47,76	55452285007 57,76	1
3 Q8 RBWC Guarnitura Q8 ros./bocc. Wc Lever handle 8mm on rose wc hole escutcheon	55452288001 62,26	55452288003 57,76	55452288007 69,76	1
4 Q8 ROC Guarnitura Q8 ros. ovale senza bocc. Lever handle 8mm on oval rose	55452220501 49,32	55452220503 47,32	55452220507 55,32	1
4 Q8 RBOC Guarnitura Q8 ros/boc. ovale patent Lever handle 8mm on oval rose key hole escutcheon	55452221501 55,03	55452221503 52,53	55452221507 62,53	1
4 Q8 RBOYC Guarnitura Q8 ros/boc. ovale Yale Lever handle 8mm on oval rose - cyl. hole escutcheon	55452225501 55,03	55452225503 52,53	55452225507 62,53	1

PORTA

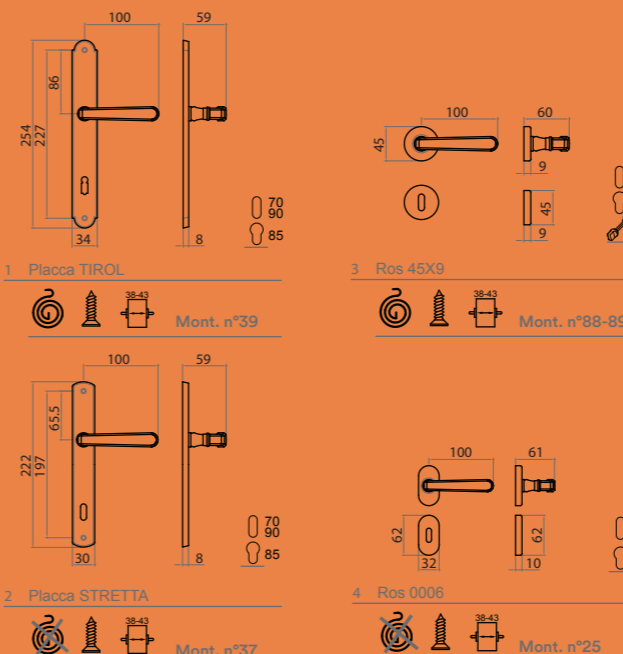

Per istruzioni di montaggio scansiona QR code, seleziona il numero di riferimento e segui le istruzioni.  
For assembly instructions scan the QR code, select the relevant assembly number and follow the instructions.

# UNO



OLV OGV OCL



G-PLUS OLV OLV OLV

	OLV	OCS	OGV	OCL	Conf. Pz.
1 Q8 P90 Guarnitura Q8 placca patent 90 Lever handle 8mm on key plate 90	55796089001	55796089003	55796089004	55796089007	1
1 Q8 P70 Guarnitura Q8 placca patent 70 Lever handle 8mm on key plate 70	55796087001	55796087003	55796087004	55796087007	1
1 Q8 PY85 Guarnitura Q8 placca yale 85 Lever handle 8mm on cyl. plate 85	55796088501	55796088503	55796088504	55796088507	1
2 Q8 P90RS Guarnitura Q8 placca stretta pat 90 Lever handle 8mm on reduced key plate 90	55796051001	55796051003	55796051004	55796051007	1
2 Q8 P70RS Guarnitura Q8 placca stretta pat 70 Lever handle 8mm on reduced key plate 70	55796057001	55796057003	55796057004	55796057007	1
2 Q8 PY85RS Guarnitura Q8 placca stretta yale 85 Lever handle 8mm on reduced cyl. plate 85	55796055001	55796055003	55796055004	55796055007	1
3 Q8 R Guarnitura Q8 ros. senza bocc. Lever handle 8mm on rose	55796280001	55796280003	55796280004	55796280007	1
3 Q8 RB Guarnitura Q8 ros./bocc. patent Lever handle 8mm on rose key hole escutcheon	55796281001	55796281003	55796281004	55796281007	1
3 Q8 RBY Guarnitura Q8 ros./bocc. yale Lever handle 8mm on rose - cyl. hole escutcheon	55796285001	55796285003	55796285004	55796285007	1
3 Q8 RBWC Guarnitura Q8 ros./bocc. Wc Lever handle 8mm on rose wc hole escutcheon	55796288001	55796288003	55796288004	55796288007	1
4 Q8 ROC Guarnitura Q8 ros.ovale senza bocc. Lever handle 8mm on oval rose	55796220501	55796220503	55796220504	55796220507	1
4 Q8 RBOC Guarnitura Q8 ros/boc. ovale patent Lever handle 8mm on oval rose key hole escutcheon	55796221501	55796221503	55796221504	55796221507	1
4 Q8 RBOYC Guarnitura Q8 ros/boc. ovale Yale Lever handle 8mm on oval rose - cyl. hole escutcheon	55796225501	55796225503	55796225504	55796225507	1
5 CREM/MART SG Cremonese-martellina Q7 senza gioco Window handle without mechanism	55796400001	55796400003	55796400004	55796400007	2
6 DK X 40 Martellina DK Q7 x 40 window handle DK x 40 mm	55796557001	55796557003	55796557004	55796557007	2
6 DK X 40 C/BUSS. Martellina DK Q7 x 40 con bussole D. 9,5 window handle DK x 40mm with pins D.9,5	55796558001	55796558003	55796558004	55796558007	2

### PORTA

### FINESTRA

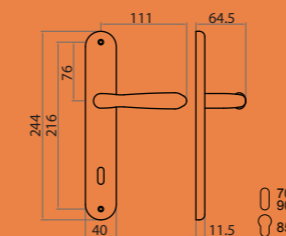

1 Placca UNO  
Mont. n°36

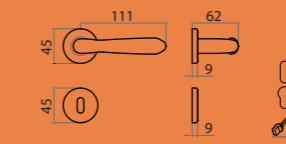

3 Ros 45X9  
Mont. n°88-89

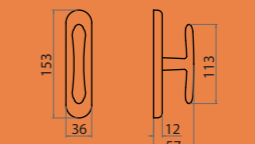

5  
Mont. n°144

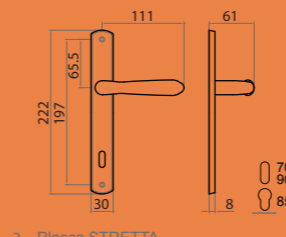

2 Placca STRETTA  
Mont. n°37

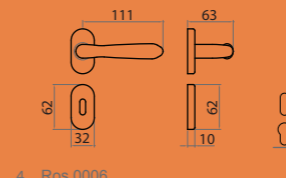

4 Ros 0006  
Mont. n°25

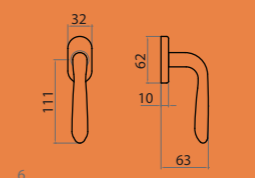

6  
Mont. n°8



Per istruzioni di montaggio scansiona QR code, seleziona il numero di riferimento e segui le istruzioni.  
For assembly instructions scan the QR code, select the relevant assembly number and follow the instructions.

# Alluminio Aluminum

170 Introduzione / Introduction  
172 Finiture / Finishes

174 142  
176 143  
178 144  
180 190  
182 239  
184 240  
186 7900  
188 7900  
190 ARCHIMEDE  
192 BRIXIA  
194 CARLO  
196 DELTA  
198 EUROPA 238  
200 GABRY  
202 ITACA 2005  
204 LEONARDO  
206 JOLLY 210  
208 PIGNA 2008  
210 SEVEN  
212 SEVEN Q  
214 SHARK  
216 SUSY - 2040  
218 UNIVERSAL  
220 UNO  
222 2071  
224 2006 CUORE



L'alluminio é sicuramente uno dei metalli non ferrosi più interessanti grazie al suo basso peso specifico ed alla sua buona resistenza alla corrosione che viene notevolmente incrementata mediante ossidazione anodica ed ora anche con l'innovativo trattamento GHI.CO.TEC

L'alluminio è un materiale responsabile, grazie alla sua capacità di essere riutilizzato all'infinito con un basso consumo energetico, rendendolo fondamentale per un futuro più sostenibile.

Aluminium is definitely one of the most interesting non-ferrous metals due to its low specific weight and its strong resistance to corrosion. This feature is considerably increased by means of anodic oxidation and now also by using the innovative GHI.CO.TEC treatment.

Aluminum is a responsible material, thanks to its ability to be endlessly reused with low energy consumption, making it essential for a more sustainable future.

# Finiture alluminio Aluminium finishing

- F4 01
- F9 02
- ACP 03
- ACS 04
- F1 05
- ANO 06
- GCTOL 07
- F3 08
- F2 09
- F1-SAT 10



01

05

07

04

02

06

08

03

10

09

Maniglie

Handles



F1



F4

	F1	F3	F4	Conf. Pz.
1 Q8 BIL Coppia maniglie con Q8 (Bilancino) Pair handle with 8mm spindle	70142208001 9,10	70142208003 9,58	70142208004 9,58	10
2 Q8 R 45 Guarnitura Q8 ros. senza bocc. Lever handle 8mm on rose	70142280001 10,05	70142280003 11,29	70142280004 11,29	10
2 Q8 RB 45 Guarnitura Q8 ros./bocc. patent Lever handle 8mm on rose key hole escutcheon	70142281001 11,00	70142281003 13,00	70142281004 13,00	10
2 Q8 RBY 45 Guarnitura Q8 ros./bocc. yale Lever handle 8mm on rose - cyl. hole escutcheon	70142285001 11,00	70142285003 13,00	70142285004 13,00	10
3 Q8 R 50 Guarnitura Q8 ros. senza bocc. Lever handle 8mm on rose	70142230001 10,33	70142230003 11,43	70142230004 11,43	10
3 Q8 RB 50 Guarnitura Q8 ros./bocc. patent Lever handle 8mm on rose key hole escutcheon	70142231001 11,58	70142231003 13,43	70142231004 13,43	10
3 Q8 RBY 50 Guarnitura Q8 ros./bocc. yale Lever handle 8mm on rose - cyl. hole escutcheon	70142235001 11,58	70142235003 13,43	70142235004 13,43	10
4 Q8 RBWC Q6 50 Guarnitura Q8 ros./bocc. Wc Q6 Lever handle 8mm on wc key hole escutcheon 6mm	70142238001 16,58	70142238003 18,57	70142238004 18,57	10

### PORTA

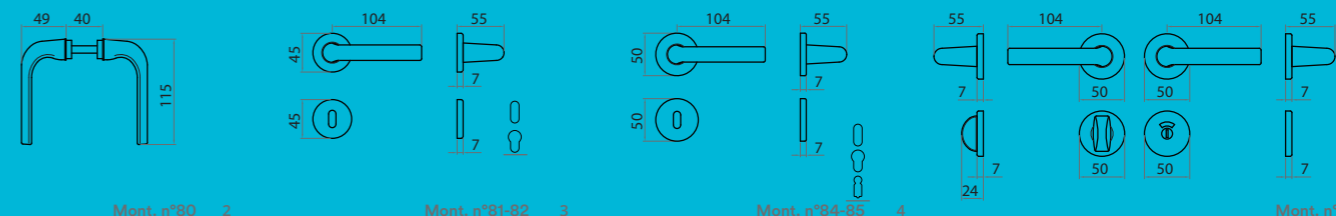

1 Mont. n°80    2 Mont. n°81-82    3 Mont. n°84-85    4 Mont. n°86

Guarnitura senza molla di ritorno - Handle without spring  
Viti non in dotazione - Screws not provided



Per istruzioni di montaggio  
scansiona QR code,  
seleziona il numero di  
riferimento e segui le  
istruzioni.  
For assembly instructions  
scan the QR code, select the  
relevant assembly number  
and follow the instructions.





F1



F4



F9

	F1	F3	F4	F9	Conf. Pz.
1 Q8 BIL Coppia maniglie con Q8 (Bilancino) Pair handle with 8mm spindle	70143208001 9,93	70143208003 10,41	70143208004 10,41	70143208009 10,41	10
2 Q8 R 45 Guarnitura Q8 ros. senza bocc. Lever handle 8mm on rose	70143280001 10,88	70143280003 12,12	70143280004 12,12	70143280009 12,12	10
2 Q8 RB 45 Guarnitura Q8 ros./bocc. patent Lever handle 8mm on rose key hole escutcheon	70143281001 11,83	70143281003 13,83	70143281004 13,83	70143281009 13,83	10
2 Q8 RBY 45 Guarnitura Q8 ros./bocc. yale Lever handle 8mm on rose - cyl. hole escutcheon	70143285001 11,83	70143285003 13,83	70143285004 13,83	70143285009 13,83	10
3 Q8 R 50 Guarnitura Q8 ros. senza bocc. Lever handle 8mm on rose	70143230001 11,16	70143230003 12,26	70143230004 12,26	70143230009 12,26	10
3 Q8 RB 50 Guarnitura Q8 ros./bocc. patent Lever handle 8mm on rose key hole escutcheon	70143231001 12,41	70143231003 14,26	70143231004 14,26	70143231009 14,26	10
3 Q8 RBY 50 Guarnitura Q8 ros./bocc. yale Lever handle 8mm on rose - cyl. hole escutcheon	70143235001 12,41	70143235003 14,26	70143235004 14,26	70143235009 14,26	10
4 Q8 RBWC Q6 50 Guarnitura Q8 ros./bocc. Wc Q6 Lever handle 8mm on wc key hole escutcheon 6mm	70143238001 17,41	70143238003 19,40	70143238004 19,40	70143238009 19,40	10

## PORTA

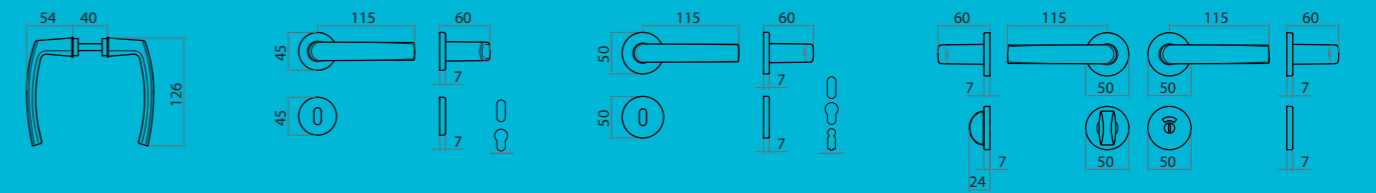

1 Mont. n°80      2 Mont. n°81-82      3 Mont. n°84-85      4 Mont. n°85



Guarnitura senza molla di ritorno - Handle without spring  
Viti non in dotazione - Screws not provided



Per istruzioni di montaggio  
scansiona QR code,  
seleziona il numero di  
riferimento e segui le  
istruzioni.  
For assembly instructions  
scan the QR code, select the  
relevant assembly number  
and follow the instructions.



F1

F4



F9

	F1	F3	F4	F9	Conf. Pz.
1 Q8 BIL Coppia maniglie con Q8 (Bilancino) Pair handle with 8mm spindle	70144208001	70144208003	70144208004	70144208009	10
2 Q8 R 45 Guarnitura Q8 ros. senza bocc. Lever handle 8mm on rose	70144280001	70144280003	70144280004	70144280009	10
2 Q8 RB 45 Guarnitura Q8 ros./bocc. patent Lever handle 8mm on rose key hole escutcheon	70144281001	70144281003	70144281004	70144281009	10
2 Q8 RBY 45 Guarnitura Q8 ros./bocc. yale Lever handle 8mm on rose - cyl. hole escutcheon	70144285001	70144285003	70144285004	70144285009	10
3 Q8 R 50 Guarnitura Q8 ros. senza bocc. Lever handle 8mm on rose	70144230001	70144230003	70144230004	70144230009	10
3 Q8 RB 50 Guarnitura Q8 ros./bocc. patent Lever handle 8mm on rose key hole escutcheon	70144231001	70144231003	70144231004	70144231009	10
3 Q8 RBY 50 Guarnitura Q8 ros./bocc. yale Lever handle 8mm on rose - cyl. hole escutcheon	70144235001	70144235003	70144235004	70144235009	10
4 Q8 RBWC Q6 50 Guarnitura Q8 ros./bocc. Wc Q6 Lever handle 8mm on wc key hole escutcheon 6mm	70144238001	70144238003	70144238004	70144238009	10

### PORTA

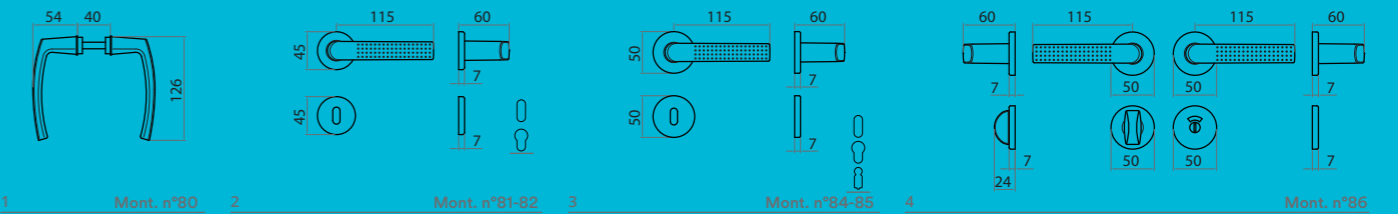

1 Mont. n°80    2 Mont. n°81-82    3 Mont. n°84-85    4 Mont. n°86

Guarnitura senza molla di ritorno - Handle without spring  
Viti non in dotazione - Screws not provided



Per istruzioni di montaggio scansiona QR code, seleziona il numero di riferimento e segui le istruzioni.  
For assembly instructions scan the QR code, select the relevant assembly number and follow the instructions.

# 190



F1

F9

	F1	F3	F4	F9	Conf. Pz.
1 Q8 BIL Coppia maniglie con Q8 (Bilancino) Pair handle with 8mm spindle	70190208001 13,81	70190208003 14,29	70190208004 14,29	70190208009 14,29	10
2 Q8 R 45 Guarnitura Q8 ros. senza bocc. Lever handle 8mm on rose	70190280001 14,76	70190280003 16,00	70190280004 16,00	70190280009 16,00	10
2 Q8 RB 45 Guarnitura Q8 ros./bocc. patent Lever handle 8mm on rose key hole escutcheon	70190281001 15,71	70190281003 17,71	70190281004 17,71	70190281009 17,71	10
2 Q8 RBY 45 Guarnitura Q8 ros./bocc. yale Lever handle 8mm on rose - cyl. hole escutcheon	70190285001 15,71	70190285003 17,71	70190285004 17,71	70190285009 17,71	10
3 Q8 R 50 Guarnitura Q8 ros. senza bocc. Lever handle 8mm on rose	70190230001 15,04	70190230003 16,14	70190230004 16,14	70190230009 16,14	10
3 Q8 RB 50 Guarnitura Q8 ros./bocc. patent Lever handle 8mm on rose key hole escutcheon	70190231001 16,29	70190231003 18,14	70190231004 18,14	70190231009 18,14	10
3 Q8 RBY 50 Guarnitura Q8 ros./bocc. yale Lever handle 8mm on rose - cyl. hole escutcheon	70190235001 16,29	70190235003 18,14	70190235004 18,14	70190235009 18,14	10
4 Q8 RBWC Q6 50 Guarnitura Q8 ros./bocc. Wc Q6 Lever handle 8mm on wc key hole escutcheon 6mm	70190238001 21,29	70190238003 23,28	70190238004 23,28	70190238009 23,28	10

### PORTA

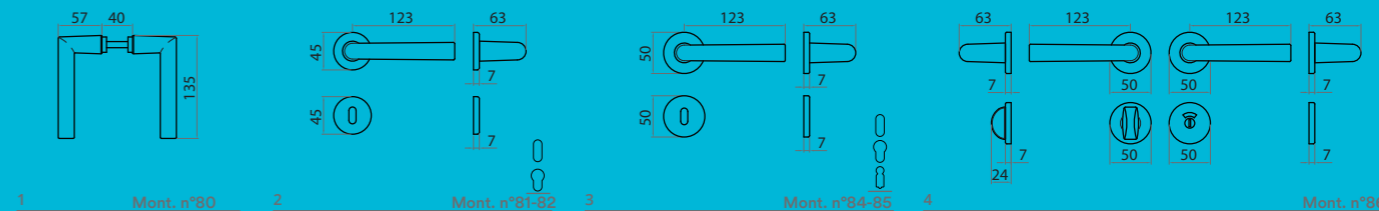

Guarnitura senza molla di ritorno - Handle without spring  
 Viti non in dotazione - Screws not provided



Per istruzioni di montaggio  
 scansiona QR code,  
 seleziona il numero di  
 riferimento e segui le  
 istruzioni.  
 For assembly instructions  
 scan the QR code, select the  
 relevant assembly number  
 and follow the instructions.



F1

F9

	F1	F3	F4	F9	Conf. Pz.
1 Q8 BIL Coppia maniglie con Q8 (Bilancino) Pair handle with 8mm spindle	70239208001 10,05	70239208003 10,93	70239208004 10,93	70239208009 10,93	10
2 Q8 R 45 Guarnitura Q8 ros. senza bocc. Lever handle 8mm on rose	70239280001 11,40	70239280003 12,64	70239280004 12,64	70239280009 12,64	10
2 Q8 RB 45 Guarnitura Q8 ros./bocc. patent Lever handle 8mm on rose key hole escutcheon	70239281001 12,35	70239281003 14,35	70239281004 14,35	70239281009 14,35	10
2 Q8 RBY 45 Guarnitura Q8 ros./bocc. yale Lever handle 8mm on rose - cyl. hole escutcheon	70239285001 12,35	70239285003 14,35	70239285004 14,35	70239285009 14,35	10
3 Q8 R 50 Guarnitura Q8 ros. senza bocc. Lever handle 8mm on rose	70239230001 11,68	70239230003 12,78	70239230004 12,78	70239230009 12,78	10
3 Q8 RB 50 Guarnitura Q8 ros./bocc. patent Lever handle 8mm on rose key hole escutcheon	70239231001 12,93	70239231003 14,78	70239231004 14,78	70239231009 14,78	10
3 Q8 RBY 50 Guarnitura Q8 ros./bocc. yale Lever handle 8mm on rose - cyl. hole escutcheon	70239235001 12,93	70239235003 14,78	70239235004 14,78	70239235009 14,78	10
4 Q8 RBWC Q6 50 Guarnitura Q8 ros./bocc. Wc Q6 Lever handle 8mm on wc key hole escutcheon 6mm	70239238001 17,93	70239238003 19,92	70239238004 19,92	70239238009 19,92	10

## PORTA

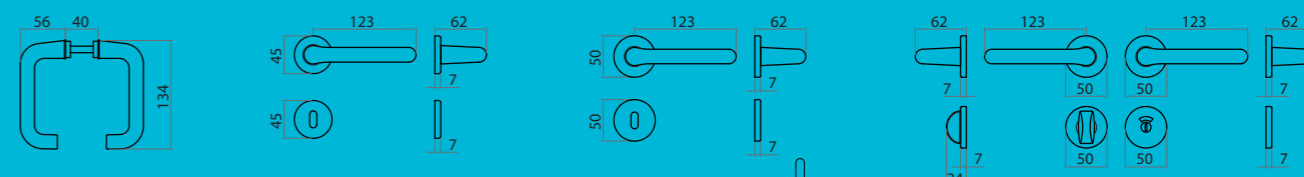

1 Mont. n°80 2 Mont. n°81-82 3 Mont. n°84-85 4 Mont. n°86

Guarnitura senza molla di ritorno - Handle without spring  
Viti non in dotazione - Screws not provided



Per istruzioni di montaggio  
scansiona QR code,  
seleziona il numero di  
riferimento e segui le  
istruzioni.  
For assembly instructions  
scan the QR code, select the  
relevant assembly number  
and follow the instructions.



F1

GCTOL

F1

	F1	GCTOL	Com Pz.
1 Q8 RB 50 C/M Guarnitura Q8 ros./bocc.patent con molla Lever handle 8mm on rose springloaded - key hole escutcheon	70240231001 24,55	70240231012 31,55	1
1 Q8 RBY 50 C/M Guarnitura Q8 ros./bocc. yale Lever handle 8mm on rose springloaded - cyl. hole escutcheon	70240235001 24,55	70240235012 31,55	1
2 Q8 RBOYC C/M Guarnitura Q8 ros./bocc. ovale yale con molla Lever handle 8mm on oval rose w/spring cylinder key hole escutcheon	70240225601 24,55	70240225612 31,55	1
2 Q8 RBOC C/M Guarnitura Q8 ros./bocc. ovale con molla Lever handle 8mm on oval rose w/spring key hole escutcheon	70240221601 24,55	70240221612 31,55	1
3 DK X 40 Martellina DK Q7 x 40 window handle DK x 40 mm	70240557001 11,45	70240557012 16,37	2
3 DK X 40 C/BUSS. Martellina DK Q7 x 40 con bussole D. 9,5 window handle DK x 40mm with pins D.9,5	70240558001 11,45	70240558012 16,37	2

### PORTA

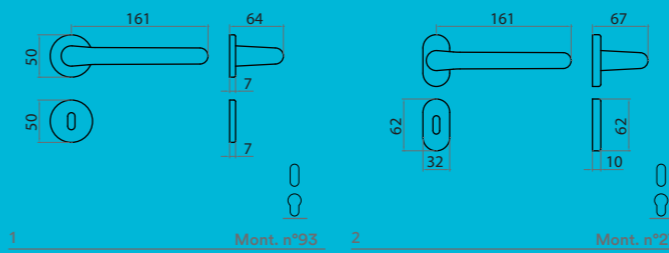

1 Mont. n°93 2 Mont. n°27

Guarnitura con molla di ritorno - Handle with spring  
Viti non in dotazione - Screws not provided

### FINESTRA

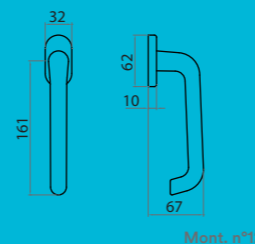

3 Mont. n°12



Per istruzioni di montaggio  
scansiona QR code,  
seleziona il numero di  
riferimento e segui le  
istruzioni.  
For assembly instructions  
scan the QR code, select the  
relevant assembly number  
and follow the instructions.

# 7900



F1



F4



F9



F1



F1



F1

	F1	F3	F4	F9	Conf. Pz.
1 Q8 BIL Coppia maniglie con Q8 (Bilancino) Pair handle with 8mm spindle	77900208001 12,02	77900208003 12,30	77900208004 12,30	77900208009 12,30	10
2 Q8 RQ50 Guarnitura Q8 ros. QUADRA senza bocc. Lever handle 8mm on square rose	77900210301 15,44	77900210303 16,15	77900210304 16,15	77900210309 16,15	10
2 Q8 RQ50 C/M Guarnitura Q8 ros. QUADRA senza bocc. con molla Lever handle 8mm on square rose spring loaded	77900210501 17,44	77900210503 18,15	77900210504 18,15	77900210509 18,15	10
2 Q8 RBQ 50 Guarnitura Q8 ros./bocc. QUADRA patent Lever handle 8mm on square rose key hole escutcheon	77900211301 18,86	77900211303 20,00	77900211304 20,00	77900211309 20,00	10
2 Q8 RBQ 50 C/M Guarnitura Q8 ros./bocc. QUADRA patent con molla Lever handle 8mm on square rose key hole escutcheon springloaded	77900211501 20,86	77900211503 22,00	77900211504 22,00	77900211509 22,00	10
2 Q8 RBQY 50 Guarnitura Q8 ros./bocc. QUADRA Yale Lever handle 8mm on square rose cyl hole escutcheon	77900215301 18,86	77900215303 20,00	77900215304 20,00	77900215309 20,00	10
2 Q8 RBQY 50 C/M Guarnitura Q8 ros./bocc. QUADRA Yale con molla Lever handle 8mm on square rose cyl hole escutcheon springloaded	77900215501 20,86	77900215503 22,00	77900215504 22,00	77900215509 22,00	10
3 Q8 RBQWC Q6 50 Guarnitura Q8 ros./bocc. QUADRA Wc Q6 Lever handle 8mm on square rose wc hole escutcheon 6mm	77900218001 24,00	77900218003 25,15	77900218004 25,15	77900218009 25,15	10
3 Q8 RBQWC Q6 50 C/M Guarnitura Q8 ros./bocc. QUADRA Wc Q6 con molla Lever handle 8mm on square rose wc hole escutcheon 6mm springloaded	77900218501 26,00	77900218503 27,15	77900218504 27,15	77900218509 27,15	10
4 Q8 RRC Guarnitura Q8 ros. RETT. senza bocc. con molla Lever handle 8mm on rectangular rose springloaded	77900280401 17,54	77900280403 18,25	77900280404 18,25	77900280409 18,25	10
4 Q8 RBR Guarnitura Q8 ros./bocc. RETT. Patent con molla Lever handle 8mm on springloaded rectangular rose key hole escutcheon	77900281401 21,06	77900281403 22,20	77900281404 22,20	77900281409 22,20	10
4 Q8 RBYR Guarnitura Q8 ros./bocc. rett.yale molla dx/sx Lever handle 8mm on rectangular springloaded rose key hole escutcheon	77900285401 21,06	77900285403 22,20	77900285404 22,20	77900285409 22,20	10
5 DK40-35 BUS. 9,5 7900 GHTEK DK40-35 BUS. 9,5 window handle DK x 40mm with pins D.9,5	77900583001 9,02	77900583003 9,39	77900583004 9,39	77900583009 9,39	20
6 DK X 40 BUS. 9,5 SECURPULL 7900 DK Q7 x 40 BUSS. 9,5 SECURPULL window handle DK x 40 mm with pins D.9,5 SECURPULL	77900575001 10,62	77900575003 10,99	77900575004 10,99	77900575009 10,99	20
7 BALCONY DOOR Guarnitura su rosetta bocchetta yale per porta balcone Q7 - viti pa: Lever handle 7mm on rectangular rose key hole escutcheon with metric-thread screw	77900217301 46,38	77900217301 46,38	77900217304 47,74	77900217309 54,90	

### PORTA

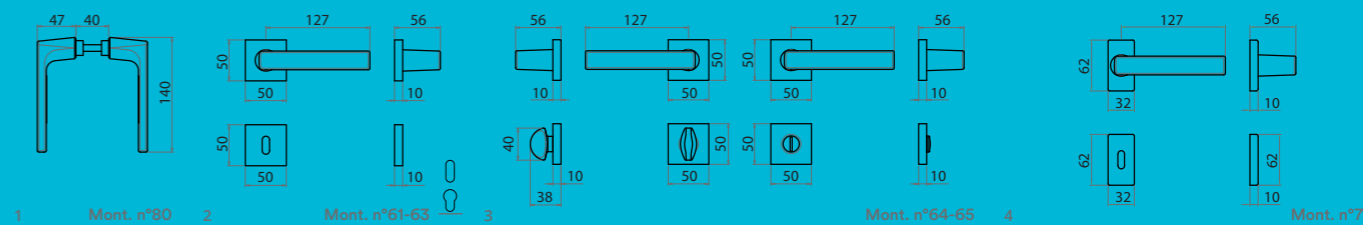

Guarnitura senza molla di ritorno - Handle without spring  
Viti non in dotazione - Screws not provided

### FINESTRA

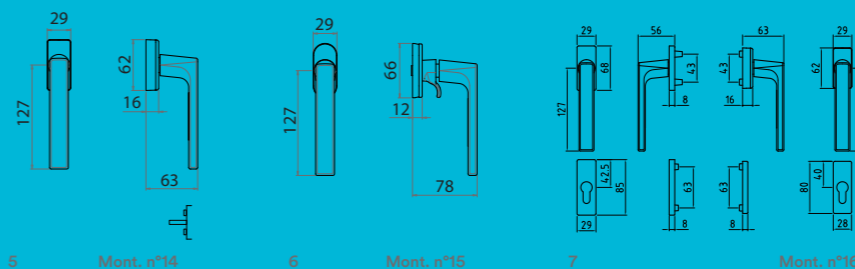

Per istruzioni di montaggio  
scansiona QR code,  
seleziona il numero di  
riferimento e segui le  
istruzioni.  
For assembly instructions  
scan the QR code, select the  
relevant assembly number  
and follow the instructions.

# 7900



F1-SAT



GCTOL



ANO



RAL9010



F1



F1



F1

	RAL9010	GCTOL	ANO	F1-SAT	Conf. Pz.
1 Q8 BIL Coppia maniglie con Q8 (Bilancino) Pair handle with 8mm spindle	77900208007	77900208012	77900208016	77900208033	10
2 Q8 RQ50 Guarnitura Q8 ros. QUADRA senza bocc. Lever handle 8mm on square rose	77900210307	77900210312	77900210316	77900210333	10
2 Q8 RQ50 C/M Guarnitura Q8 ros. QUADRA senza bocc. con molla Lever handle 8mm on square rose spring loaded	77900210507	77900210512	77900210516	77900210533	10
2 Q8 RBQ 50 Guarnitura Q8 ros./bocc. QUADRA patent Lever handle 8mm on square rose key hole escutcheon	77900211307	77900211312	77900211316	77900211333	10
2 Q8 RBQ 50 C/M Guarnitura Q8 ros./bocc. QUADRA patent con molla Lever handle 8mm on square rose key hole escutcheon springloaded	77900211507	77900211512	77900211516	77900211533	10
2 Q8 RBQY 50 Guarnitura Q8 ros./bocc. QUADRA Yale Lever handle 8mm on square rose cyl hole escutcheon	77900215307	77900215312	77900215316	77900215333	10
2 Q8 RBQY 50 C/M Guarnitura Q8 ros./bocc. QUADRA Yale con molla Lever handle 8mm on square rose cyl hole escutcheon springloaded	77900215507	77900215512	77900215516	77900215533	10
3 Q8 RBQWC Q6 50 Guarnitura Q8 ros./bocc. QUADRA Wc Q6 Lever handle 8mm on square rose wc hole escutcheon 6mm	77900218007	77900218012	77900218016	77900218033	10
3 Q8 RBQWC Q6 50 C/M Guarnitura Q8 ros./bocc. QUADRA Wc Q6 con molla Lever handle 8mm on square rose wc hole escutcheon 6mm springloaded	77900218507	77900218512	77900218516	77900218533	10
4 Q8 RRC Guarnitura Q8 ros. RETT. senza bocc. con molla Lever handle 8mm on rectangular rose springloaded	77900280407	77900280412	77900280416	77900280433	10
4 Q8 RBR Guarnitura Q8 ros./bocc. RETT. Patent con molla Lever handle 8mm on springloaded rectangular rose key hole escutcheon	77900281407	77900281412	77900281416	77900281433	10
4 Q8 RBYR Guarnitura Q8 ros./bocc. rett.yale molla dx/sx Lever handle 8mm on rectangular springloaded rose key hole escutcheon	77900285407	77900285412	77900285416	77900285433	10
5 DK40-35 BUS, 9,5 7900 GHTEK DK40-35 BUS. 9,5 window handle DK x 40mm with pins D.9,5	77900583007	77900583012	77900583016	77900583033	20
6 DK X 40 BUS, 9,5 SECURPULL 7900 DK Q7 x 40 BUSS. 9,5 SECURPULL window handle DK x 40 mm with pins D.9,5 SECURPULL	77900575007	77900575012	77900575016	77900575033	20
7 BALCONY DOOR G.ra ros bocc yale per porta balcone Q7 - viti pass Lever handle 7mm on rect rose key hole esc. metric-thread screw	77900217307	77900217312	77900217316	77900217333	

### PORTA

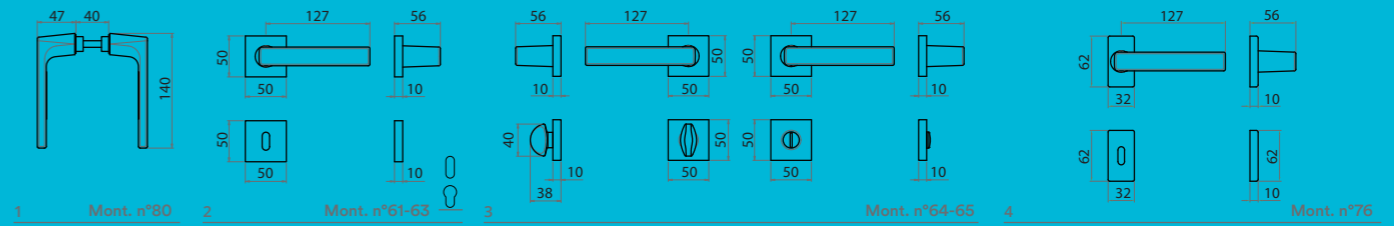

Guarnitura senza molla di ritorno - Handle without spring  
Viti non in dotazione - Screws not provided

### FINESTRA

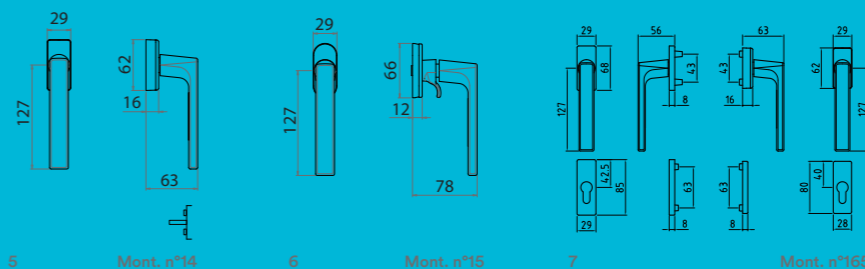

Per istruzioni di montaggio  
scansiona QR code,  
seleziona il numero di  
riferimento e segui le  
istruzioni.  
For assembly instructions  
scan the QR code, select the  
relevant assembly number  
and follow the instructions.

# ARCHIMEDE



F1-SAT



77696

Archimede

Aluminum

Handles

	F1-SAT	Conf. Pz.
1 Q8 RBQ Guarnitura Q8 ros./bocc. patent Lever handle 8mm on rose key hole escutcheon	77696211333 38,09	1
2 Q8 RBQY Guarnitura Q8 ros./bocc. yale Lever handle 8mm on rose - cyl. hole escutcheon	77696215333 38,09	1
2 Q8 RBWCQ Guarnitura Q8 ros./bocc. Wc Lever handle 8mm on rose wc hole escutcheon	77696218333 47,47	1
2 DK x 40 Martellina DK Q7 x 40 window handle DK x 40 mm	77696555033 12,95	2
2 DK X 40 C/BUS Martellina DK Q7 x 40 con bussole D. 9,5 window handle DK x 40mm with pins D.9,5	77696556033 12,95	2

77696

Archimede

Alluminio

Maniglie

### PORTA

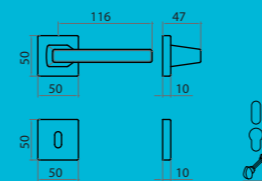

1 Ros 50x50x10 ALL  

 Mont. n°61-64

### FINESTRA

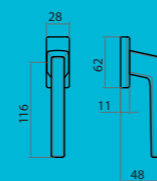

2 DK-3P  

 Mont. n°10



Per istruzioni di montaggio  
scansiona QR code,  
seleziona il numero di  
riferimento e segui le  
istruzioni.  
For assembly instructions  
scan the QR code, select the  
relevant assembly number  
and follow the instructions.



# BRIXIA



	F1	F3	F4	F9	Conf. Pz.
1 Q8 BIL Coppia maniglie con Q8 (Bilancino) Pair handle with 8mm spindle	77438208001 9,82	77438208003 10,16	77438208004 10,16	77438208009 10,16	10
2 Q8 P90 Guarnitura Q8 placca patent 90 Lever handle 8mm on key plate 90	77438089001 13,75	77438089003 14,88	77438089004 14,88	77438089009 14,88	10
2 Q8 P70 Guarnitura Q8 placca patent 70 Lever handle 8mm on key plate 70	77438087001 13,75	77438087003 14,88	77438087004 14,88	77438087009 14,88	10
2 Q8 PY85 Guarnitura Q8 placca yale 85 Lever handle 8mm on cyl. plate 85	77438088501 13,75	77438088503 14,88	77438088504 14,88	77438088509 14,88	10
3 Q8 R 45 Guarnitura Q8 ros. senza bocc. Lever handle 8mm on rose	77438280001 10,77	77438280003 11,87	77438280004 11,87	77438280009 11,87	10
3 Q8 RB 45 Guarnitura Q8 ros./bocc. patent Lever handle 8mm on rose key hole escutcheon	77438281001 11,72	77438281003 13,58	77438281004 13,58	77438281009 13,58	10
3 Q8 RBY 45 Guarnitura Q8 ros./bocc. yale Lever handle 8mm on rose - cyl. hole escutcheon	77438285001 11,72	77438285003 13,58	77438285004 13,58	77438285009 13,58	10
4 Q8 R 50 Guarnitura Q8 ros. senza bocc. Lever handle 8mm on rose	77438230001 10,90	77438230003 12,00	77438230004 12,00	77438230009 12,00	10
4 Q8 RB 50 Guarnitura Q8 ros./bocc. patent Lever handle 8mm on rose key hole escutcheon	77438231001 12,15	77438231003 14,00	77438231004 14,00	77438231009 14,00	10
4 Q8 RBY 50 Guarnitura Q8 ros./bocc. yale Lever handle 8mm on rose - cyl. hole escutcheon	77438235001 12,15	77438235003 14,00	77438235004 14,00	77438235009 14,00	10
5 Q8 RBWC Q6 50 Guarnitura Q8 ros./bocc. Wc Q6 Lever handle 8mm on wc key hole escutcheon 6mm	77438238001 17,15	77438238003 19,14	77438238004 19,14	77438238009 19,14	10
5 DKx33 8SC BUS. 9,5 BRIXIA DKx33 8SC BUS. 9,5 window handle DK x 33mm with pins D 9,5	7743855830158 6,60	7743855830358 6,97	7743855830458 6,97	7743855830958 6,97	100
6 DKx35 8SC BUS. 9,5 BRIXIA DKx35 8SC BUS. 9,5 window handle DK x 35mm with pins D 9,5	7743855850158 6,60	7743855850358 6,97	7743855850458 6,97	7743855850958 6,97	100
6 DKx40 8SC BUS. 9,5 BRIXIA DKx40 8SC BUS. 9,5 window handle DK x 40mm with pins D 9,5	7743855800158 6,60	7743855800358 6,97	7743855800458 6,97	7743855800958 6,97	100
6 DKx45 8SC BUS. 9,5 BRIXIA DKx45 8SC BUS. 9,5 window handle DK x 45mm with pins D 9,5	7743855840158 6,60	7743855840358 6,97	7743855840458 6,97	7743855840958 6,97	100
7 BALCONY DOOR G.ra ros bocc yale per porta balcone Q7 - viti pass Lever handle 7mm on rect rose key hole esc metric-thread screw	77438227301 43,65	77438227303	77438227304	77438227309 50,20	

## PORTA

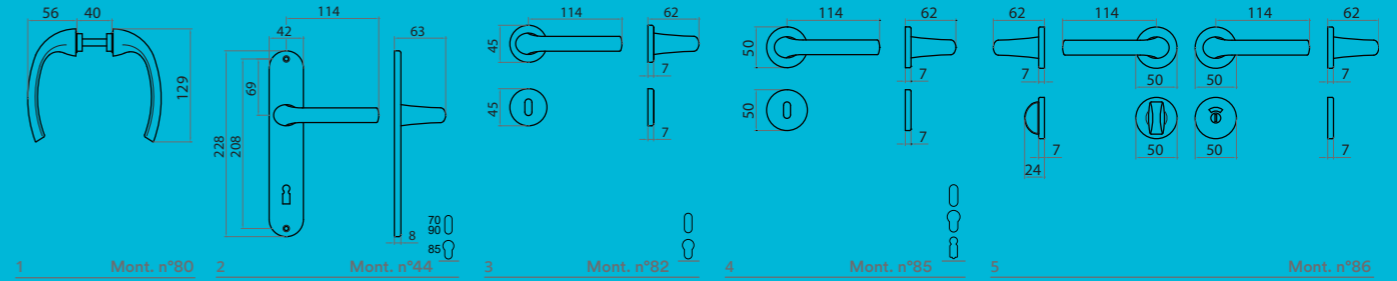

Guarnitura senza molla di ritorno - Handle without spring  
Viti non in dotazione - Screws not provided

## FINESTRA

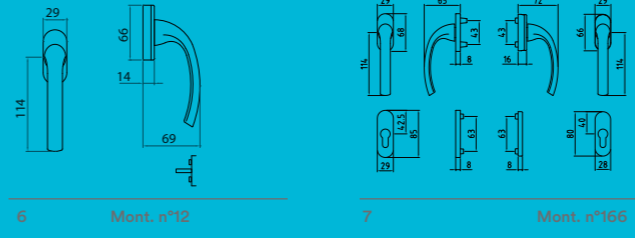

Per istruzioni di montaggio  
scansiona QR code,  
seleziona il numero di  
riferimento e segui le  
istruzioni.  
For assembly instructions  
scan the QR code, select the  
relevant assembly number  
and follow the instructions.

# CARLO

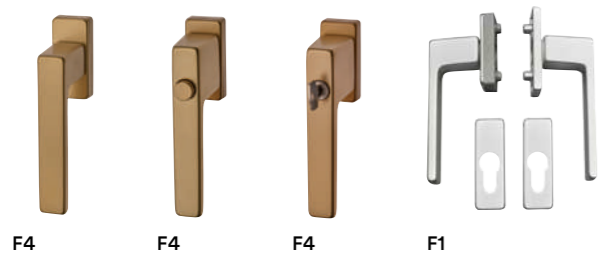

Per istruzioni di montaggio scansiona QR code, seleziona il numero di riferimento e segui le istruzioni.  
For assembly instructions scan the QR code, select the relevant assembly number and follow the instructions.

	F1	F4	F9	ANO	RAL9016	Conf. Pz.
1 Q8 BIL Coppia maniglie con Q8 (Bilancino) Pair handle with 8mm spindle	77502208001 10,80	77502208004 11,35	77502208009 11,35	77502208016 11,58	77502208080 11,35	10
2 Q8 RQ 45X45X10 Guarnitura Q8 ros. QUADRA senza bocc. Lever handle 8mm on square rose	77502240001 13,15	77502240004 14,25	77502240009 14,25	77502240016 15,08	77502240080 14,25	10
2 Q8 RQ 45X45X10 C/M Guarnitura Q8 ros. QUADRA senza bocc. con molla Lever handle 8mm on square rose springloaded	77502240501 15,15	77502240504 15,25	77502240509 15,25	77502240516 17,08	77502240580 15,25	10
2 Q8 RBQ 45X45X10 Guarnitura Q8 ros./bocc. QUADRA patent Lever handle 8mm on square rose key hole escutcheon	77502241001 16,00	77502241004 17,15	77502241009 17,15	77502241016 18,58	77502241080 17,15	10
2 Q8 RBQ 45X45X10 C/M Guarnitura Q8 ros./bocc. QUADRA patent con molla Lever handle 8mm on square rose key hole escutcheon springloaded	77502241501 18,00	77502241504 19,15	77502241509 19,15	77502241516 20,58	77502241580 19,15	10
2 Q8 RBQY 45X45X10 Guarnitura Q8 ros./bocc. QUADRA Yale Lever handle 8mm on square rose cyl hole escutcheon	77502245001 16,00	77502245004 17,15	77502245009 17,15	77502245016 18,58	77502245080 17,15	10
2 Q8 RBQY 45X45X10 C/M Guarnitura Q8 ros./bocc. QUADRA Yale con molla Lever handle 8mm on square rose cyl hole escutcheon springloaded	77502245501 18,00	77502245504 19,15	77502245509 19,15	77502245516 20,58	77502245580 19,15	10
3 Q8 RBR Guarnitura Q8 ros./bocc. RETT. patent Lever handle 8mm on springloaded rect rose key hole esc	77502281401 20,00	77502281404 21,15	77502281409 21,15	77502281416 22,58	77502281480 21,15	10
3 Q8 RBYR Guarnitura Q8 ros./bocc. rett.yale molla dx/sx Lever handle 8mm on springloaded rect rose - cyl. hole esc	77502285401 20,00	77502285404 21,15	77502285409 21,15	77502285416 22,58	77502285480 21,15	10
4 Q8 RBQWC Q6 45X45X10 Guarnitura Q8 ros./bocc. QUADRA Wc Q6 Lever handle 8mm on square rose wc hole escutcheon 6mm	77502248001 23,00	77502248004 24,45	77502248009 24,45	77502248016 26,18	77502248080 24,45	10
4 Q8 RBQWC Q6 45X45X10 C/M Guarnitura Q8 ros./bocc. QUADRA Wc Q6 con molla Lever handle 8mm on square rose wc hole escutcheon 6mm springloaded	77502248501 25,00	77502248504 26,45	77502248509 26,45	77502248516 28,18	77502248580 26,45	10
5 DK X 35 C/BUSS D.9,5 CARLO DKX35 8SC RET BUS.9,5 window handle DK x 35mm with pins D.9,5	7750255650108 6,61	7750255650408 7,89	7750255650908 7,89	7750255651608 8,50	7750255658008 5,59	100
5 DK X 40 C/BUSS D.9,5 CARLO DK Q7 x 40 con bussole D. 9,5 window handle DK x 40mm with pins D.9,5	7750255600108 6,61	7750255600408 7,89	7750255600908 10,25	7750255601608 8,50	7750255608008 5,59	20
5 DK X 45 C/BUSS D.9,5 CARLO DKX45 8SC RET BUS.9,5 window handle DK x 45mm with pins D.9,5	7750255640108 6,61	7750255640408 7,89	7750255640908 7,89	7750255641608 8,50	7750255648008 5,59	100
5 DK X 50 C/BUSS D.9,5 CARLO DKX50 8SC RET BUS.9,5 window handle DK x 50mm with pins D.9,5	7750255660108 6,61	7750255660408 7,89	7750255660908 7,89	7750255661608 8,50	7750255668008 5,59	100
6 DK X 40 C/BUSS D.9,5 CARLO con pulsante DK Q7 x 40 con bussole D. 9,5 window handle DK x 40mm with pins D.9,5	77502562501 23,41	77502562504 25,14	77502562509 32,70	77502562516 39,41	77502562580 28,19	5
7 DK X 45 C/BUSS D.9,5 CARLO con chiave DK Q7 x 45 con bussole D. 9,5 window handle DK x 45mm with pins D.9,5	77502563301 27,52	77502563304 29,61	77502563309 38,44	77502563316 35,65	77502563380 26,20	5
7 DK X 40 C/BUSS D.9,5 CARLO con chiave DK Q7 x 40 con bussole D. 9,5 window handle DK x 40mm with pins D.9,5	77502563501 27,52	77502563504 29,61	77502563509 38,44	77502563516 35,65	77502563580 26,20	5
8 BALCONY DOOR G.ra ros bocc yale per porta balcone Q7 - viti pass Lever handle 7mm on rect rose key hole esc metric-thread screw	77502217301 60,14	77502217304 62,99	77502217309 62,99	77502217316 77,73	77502217380 57,91	
9 BALCONY DOOR G.ra ros bocc yale per porta balcone Q7 - viti pass Lever handle 7mm on rect rose key hole esc metric-thread screw	77502217501 62,99	77502217504 65,84	77502217509 65,84	77502217516 81,29	77502217580 60,75	

### PORTA

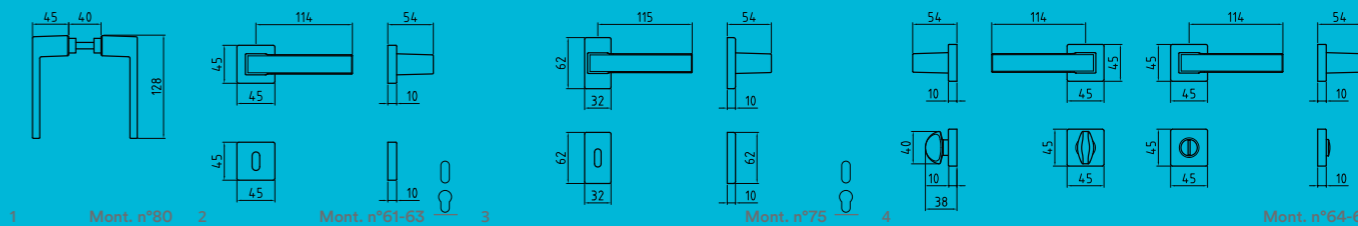

Guarnitura con molla di ritorno - Handle with spring  
Viti non in dotazione - Screws not provided

### FINESTRA

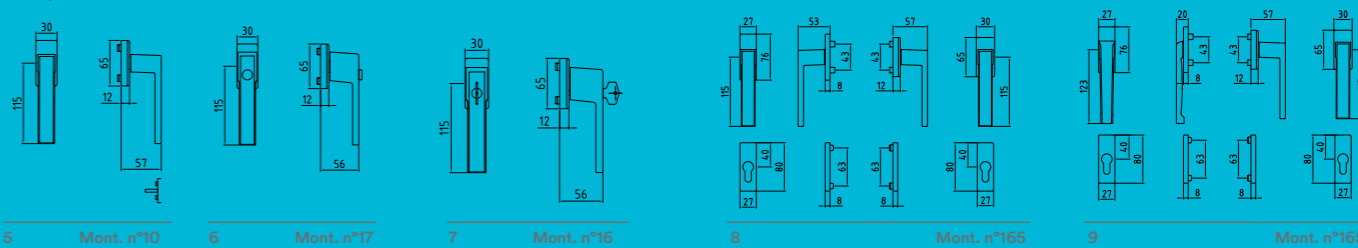

# DELTA



F1



F4



F9



F41

	F1	F3	F4	RAL9010	F9	ANO	Conf. Pz.
1 Q8 BIL Coppia maniglie con Q8 (Bilancino) Pair handle with 8mm spindle	77210208001	77210208003	77210208004	77210208007	77210208009	77210208016	10
2 Q8 RQ 50 Guarnitura Q8 ros. QUADRA senza bocc. Lever handle 8mm on square rose	77210210301	77210210303	77210210304	77210210307	77210210309	77210210316	10
2 Q8 RBQ 50 Guarnitura Q8 ros./bocc. QUADRA patent Lever handle 8mm on square rose key hole escutcheon	77210211301	77210211303	77210211304	77210211307	77210211309	77210211316	10
2 Q8 RBQY 50 Guarnitura Q8 ros./bocc. QUADRA Yale Lever handle 8mm on square rose cyl hole escutcheon	77210215301	77210215303	77210215304	77210215307	77210215309	77210215316	10
3 Q8 RBQWC Guarnitura Q8 ros./bocc. QUADRA Wc Q6 Lever handle 8mm on square rose wc hole escutcheon 6mm	77210218001	77210218003	77210218004	77210218007	77210218009	77210218016	10
3 DK x 45 C/BUSS D.9,5 DELTA DK X 45 C/BUSS D.9,5 window handle DK x 45 mm with pins D.9,5	7721055600158	7721055600358	7721055600458	7721055600758	7721055600958	7721055601658	100
4 DK X 45 BUS. 9,5 GHTECH DELTA DK X 45 BUS. 9,5 GHTECH window handle DK x 45 mm with pins D.9,5 GHTECH	77210583001	77210583003	77210583004	77210583007	77210583009	77210583016	10

### PORTA

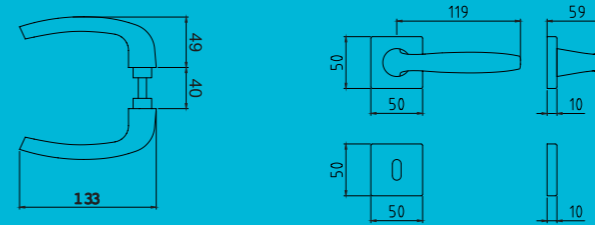

1

Mont. n°80

2

Mont. n°61-62



Guarnitura con molla di ritorno - Handle with spring  
Viti non in dotazione - Screws not provided

### FINESTRA

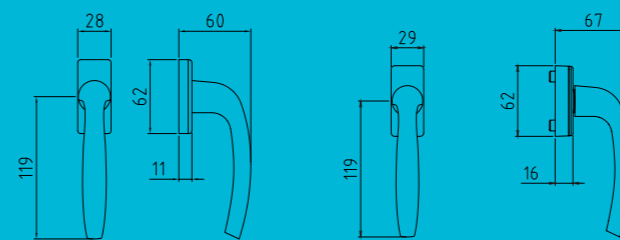

3

Mont. n°10

4

Mont. n°13



Per istruzioni di montaggio  
scansiona QR code,  
seleziona il numero di  
riferimento e segui le  
istruzioni.  
For assembly instructions  
scan the QR code, select the  
relevant assembly number  
and follow the instructions.

# EUROPA 238



F1

F4

F9



F4

	F1	F3	F4	F9	Conf. Pz.
1 Q8 BIL Coppia maniglie con Q8 (Bilancino) Pair handle with 8mm spindle	70238208001 10,05	70238208003 10,93	70238208004 10,93	70238208009 10,93	10
2 Q8 P90 Guarnitura Q8 placca patent 90 Lever handle 8mm on key plate 90	70238089001 13,51	70238089003 15,15	70238089004 15,15	70238089009 15,15	10
2 Q8 P70 Guarnitura Q8 placca patent 70 Lever handle 8mm on key plate 70	70238087001 13,51	70238087003 15,15	70238087004 15,15	70238087009 15,15	10
2 Q8 PY85 Guarnitura Q8 placca yale 85 Lever handle 8mm on cyl. plate 85	70238088501 13,51	70238088503 15,15	70238088504 15,15	70238088509 15,15	10
3 Q8 R 45 Guarnitura Q8 ros. senza bocc. Lever handle 8mm on rose	70238280001 11,40	70238280003 12,64	70238280004 12,64	70238280009 12,64	10
3 Q8 RB 45 Guarnitura Q8 ros./bocc. patent Lever handle 8mm on rose key hole escutcheon	70238281001 12,35	70238281003 14,35	70238281004 14,35	70238281009 14,35	10
3 Q8 RBY 45 Guarnitura Q8 ros./bocc. yale Lever handle 8mm on rose - cyl. hole escutcheon	70238285001 12,35	70238285003 14,35	70238285004 14,35	70238285009 14,35	10
4 Q8 R 50 Guarnitura Q8 ros. senza bocc. Lever handle 8mm on rose	70238230001 11,68	70238230003 12,78	70238230004 12,78	70238230009 12,78	10
4 Q8 RB 50 Guarnitura Q8 ros./bocc. patent Lever handle 8mm on rose key hole escutcheon	70238231001 16,29	70238231003 18,14	70238231004 18,14	70238231009 18,14	10
4 Q8 RBY 50 Guarnitura Q8 ros./bocc. yale Lever handle 8mm on rose - cyl. hole escutcheon	70238235001 16,29	70238235003 18,14	70238235004 18,14	70238235009 18,14	10
5 Q8 RBWC Q6 50 Guarnitura Q8 ros./bocc. Wc Q6 Lever handle 8mm on wc key hole escutcheon 6mm	70238238001 21,29	70238238003 23,28	70238238004 23,28	70238238009 23,28	10
6 DKx33 8SC BUS. 9,5 4038 DKx33 8SC BUS. 9,5 window handle DK x 33mm with pins D.9,5	7403855830158 6,60	7403855830358 6,97	7403855830458 6,97	7403855830958 6,97	100
6 DKx35 8SC BUS. 9,5 4038 DKx35 8SC BUS. 9,5 window handle DK x 35mm with pins D.9,5	7403855850158 6,60	7403855850358 6,97	7403855850458 6,97	7403855850958 6,97	100
6 DKx40 8SC BUS. 9,5 4038 DKx40 8SC BUS. 9,5 window handle DK x 40mm with pins D.9,5	7403855800158 6,60	7403855800358 6,97	7403855800458 6,97	7403855800958 6,97	100
6 DKx45 8SC BUS. 9,5 4038 DKx45 8SC BUS. 9,5 window handle DK x 45mm with pins D.9,5	7403855840158 6,60	7403855840358 6,97	7403855840458 6,97	7403855840958 6,97	100

**PORTA**

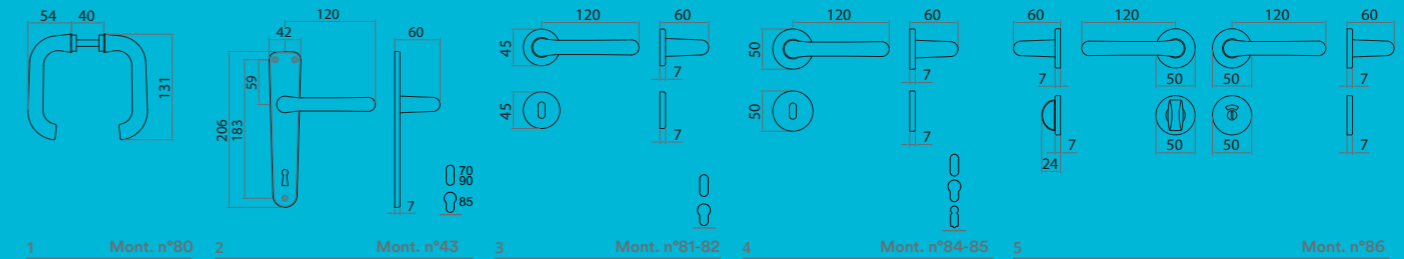

1 Mont. n°80 2 Mont. n°43 3 Mont. n°81-82 4 Mont. n°84-85 5 Mont. n°86

Guarnitura senza molla di ritorno - Handle without spring  
Viti non in dotazione - Screws not provided

**FINESTRA**

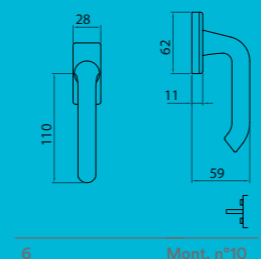

6 Mont. n°10



Per istruzioni di montaggio scansiona QR code, seleziona il numero di riferimento e segui le istruzioni.  
For assembly instructions scan the QR code, select the relevant assembly number and follow the instructions.

# GABRY



F1



F4



F4

	F1	F3	F4	Conf. Pz.
1 Q8 BIL Coppia maniglie con Q8 (Bilancino) Pair handle with 8mm spindle	77400208001 9,82	77400208003 10,16	77400208004 10,16	10
2 Q8 P90 Guarnitura Q8 placca patent 90 Lever handle 8mm on key plate 90	77400089001 13,28	77400089003 14,38	77400089004 14,38	10
2 Q8 P70 Guarnitura Q8 placca patent 70 Lever handle 8mm on key plate 70	77400087001 13,28	77400087003 14,38	77400087004 14,38	10
2 Q8 PY85 Guarnitura Q8 placca yale 85 Lever handle 8mm on cyl. plate 85	77400088501 13,28	77400088503 14,38	77400088504 14,38	10
2 Q8 P90 fissa Guarnitura Q8 placca patent 90 fissa Lever handle 8mm on fixed key plate 90	7740008900153 14,28	7740008900353 14,38	7740008900453 14,38	10
2 Q8 P70 fissa Guarnitura Q8 placca patent 70 fissa Lever handle 8mm on key plate 70	7740008700153 14,28	7740008700353 14,38	7740008700453 14,38	10
2 Q8 PY85 fissa Guarnitura Q8 placca yale 85 fissa Lever handle 8mm on fixed cylinder plate 85 packing 50 pairs	7740008850153 14,28	7740008850353 14,38	7740008850453 14,38	10
3 Q8 R 45 Guarnitura Q8 ros. senza bocc. Lever handle 8mm on rose	77400280001 10,77	77400280003 11,87	77400280004 11,87	10
3 Q8 RB 45 Guarnitura Q8 ros./bocc. patent Lever handle 8mm on rose key hole escutcheon	77400281001 11,72	77400281003 13,58	77400281004 13,58	10
3 Q8 RBY 45 Guarnitura Q8 ros./bocc. yale Lever handle 8mm on rose - cyl. hole escutcheon	77400285001 11,72	77400285003 13,58	77400285004 13,58	10
4 Q8 R 50 Guarnitura Q8 ros. senza bocc. Lever handle 8mm on rose	77400230001 10,90	77400230003 12,00	77400230004 12,00	10
4 Q8 RB 50 Guarnitura Q8 ros./bocc. patent Lever handle 8mm on rose key hole escutcheon	77400231001 12,15	77400231003 14,00	77400231004 14,00	10
4 Q8 RBY 50 Guarnitura Q8 ros./bocc. yale Lever handle 8mm on rose - cyl. hole escutcheon	77400235001 12,15	77400235003 14,00	77400235004 14,00	10
5 Q8 RBWC Q6 50 Guarnitura Q8 ros./bocc. Wc Q6 Lever handle 8mm on wc key hole escutcheon 6mm	77400238001 17,15	77400238003 19,14	77400238004 19,14	10
6 DK X 33 C/BUSS D.9,5 GABRY TN DKx33 RETT BUS window handle DK x 33mm with pins D.9,5	7740055600158 6,60	7740055600358 6,97	7740055600458 6,97	100
6 DK X 35 C/BUSS D.9,5 GABRY TN DKx35 RETT BUS window handle DK x 35mm with pins D.9,5	7740055650158 6,60	7740055650358 6,97	7740055650458 6,97	100
6 DK X 40 C/BUSS D.9,5 GABRY TN DKx40 RETT BUS window handle DK x 40mm with pins D.9,5	7740055630158 6,60	7740055630358 6,97	7740055630458 6,97	100
6 DK X 45 C/BUSS D.9,5 GABRY TN DKx45 RETT BUS window handle DK x 45mm with pins D.9,5	7740055640158 6,60	7740055640358 6,97	7740055640458 6,97	100

### PORTA

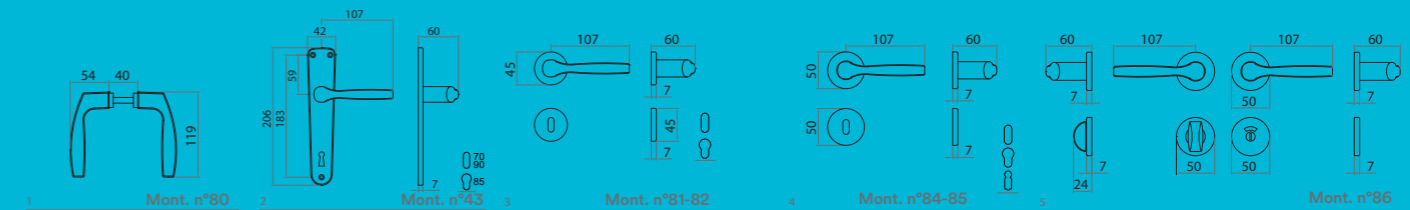

### FINESTRA

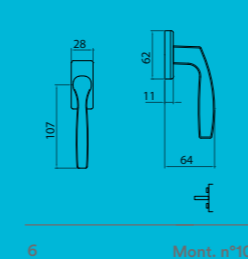

Per istruzioni di montaggio scansiona QR code, seleziona il numero di riferimento e segui le istruzioni.  
For assembly instructions scan the QR code, select the relevant assembly number and follow the instructions.

# ITACA 2005



F1

F4

F9



F4



F1



F1



Per istruzioni di montaggio  
scansiona QR code,  
seleziona il numero di  
riferimento e segui le  
istruzioni.  
For assembly instructions  
scan the QR code, select the  
relevant assembly number  
and follow the instructions.

	F1	F3	F4	F9	Conf. Pz.
1 Q8 BIL Coppia maniglie con Q8 (Bilancino) Pair handle with 8mm spindle	72005208001	72005208003	72005208004	72005208009	10
2 Q8 P90 Guarnitura Q8 placca patent 90 Lever handle 8mm on key plate 90	72005089001	72005089003	72005089004	72005089009	10
2 Q8 P70 Guarnitura Q8 placca patent 70 Lever handle 8mm on key plate 70	72005087001	72005087003	72005087004	72005087009	10
2 Q8 PY85 Guarnitura Q8 placca yale 85 Lever handle 8mm on cyl. plate 85	72005088501	72005088503	72005088504	72005088509	10
3 Q8 R 45 Guarnitura Q8 ros. senza bocc. Lever handle 8mm on rose	72005280001	72005280003	72005280004	72005280009	10
3 Q8 RB 45 Guarnitura Q8 ros./bocc. patent Lever handle 8mm on rose key hole escutcheon	72005281001	72005281003	72005281004	72005281009	10
3 Q8 RBY 45 Guarnitura Q8 ros./bocc. yale Lever handle 8mm on rose - cyl. hole escutcheon	72005285001	72005285003	72005285004	72005285009	10
4 Q8 R 50 Guarnitura Q8 ros. senza bocc. Lever handle 8mm on rose	72005230001	72005230003	72005230004	72005230009	10
4 Q8 RB 50 Guarnitura Q8 ros./bocc. patent Lever handle 8mm on rose key hole escutcheon	72005231001	72005231003	72005231004	72005231009	10
4 Q8 RBY 50 Guarnitura Q8 ros./bocc. yale Lever handle 8mm on rose - cyl. hole escutcheon	72005235001	72005235003	72005235004	72005235009	10
5 Q8 RBWC Q6 50 Guarnitura Q8 ros./bocc. Wc Q6 Lever handle 8mm on wc key hole escutcheon 6mm	72005238001	72005238003	72005238004	72005238009	10
6 DK X 33 C/BUSS D.9,5 ITACA DKX33 BUS window handle DK x 33mm with pins D.9,5	7200555830158	7200555830358	7200555830458	7200555830958	100
6 DK X 35 C/BUSS D.9,5 ITACA DKX35 BUS window handle DK x 35mm with pins D.9,5	7200555850158	7200555850358	7200555850458	7200555850958	100
6 DK X 40 C/BUSS D.9,5 ITACA DKX40 BUS window handle DK x 40mm with pins D.9,5	7200555800158	7200555800358	7200555800458	7200555800958	100
6 DK X 45 C/BUSS D.9,5 ITACA DKX45 BUS window handle DK x 45mm with pins D.9,5	7200555840158	7200555840358	7200555840458	7200555840958	100
7 DK X 40 SECURPULL ITACA SECURPULL DK40 window handle DK x 40mm SECURPULL	72005575001	72005575003	72005575004	72005575009	20
8 DK X 40-35 GHTECH ITACA GHTEK DK40-35 window handle DK x 40mm GHTECH	72005574001	72005574003	72005574004	72005574009	20
9 BALCONY DOOR G.ra ros bocc yale per porta balcone Q7 - viti pass Lever handle 7mm on rect rose key hole esc metrich-thread screw	72005227301	72005227303	72005227304	72005227309	

PORTA

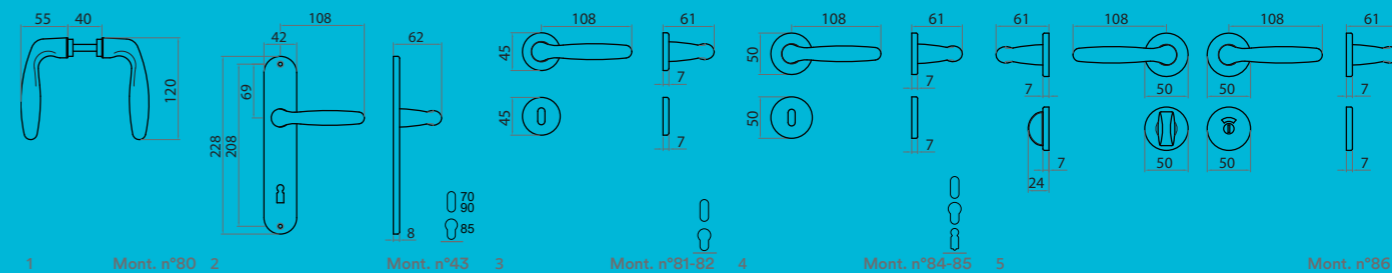

Guarnitura senza molla di ritorno - Handle without spring  
Viti non in dotazione - Screws not provided

FINESTRA

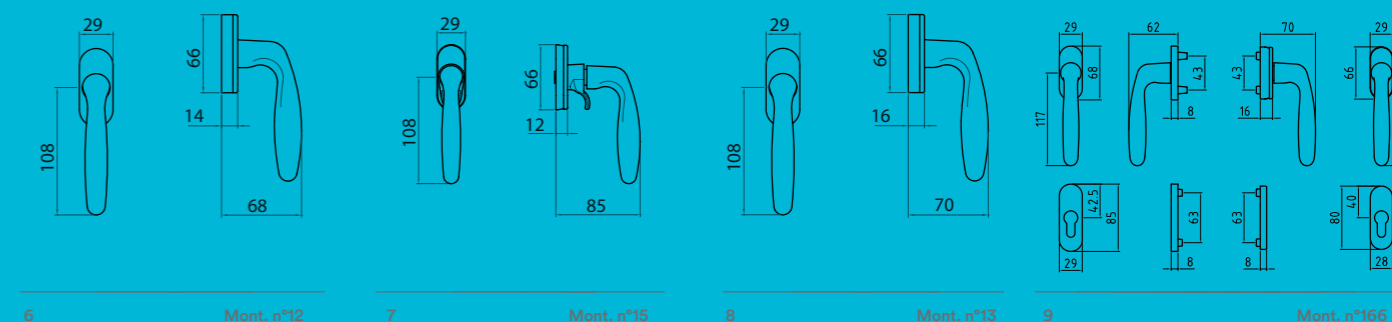

# LEONARDO

DESIGN FABRIZIO BIANCHETTI

DESIGN FOR ALL

77042

Leonardo

Aluminium

Handles

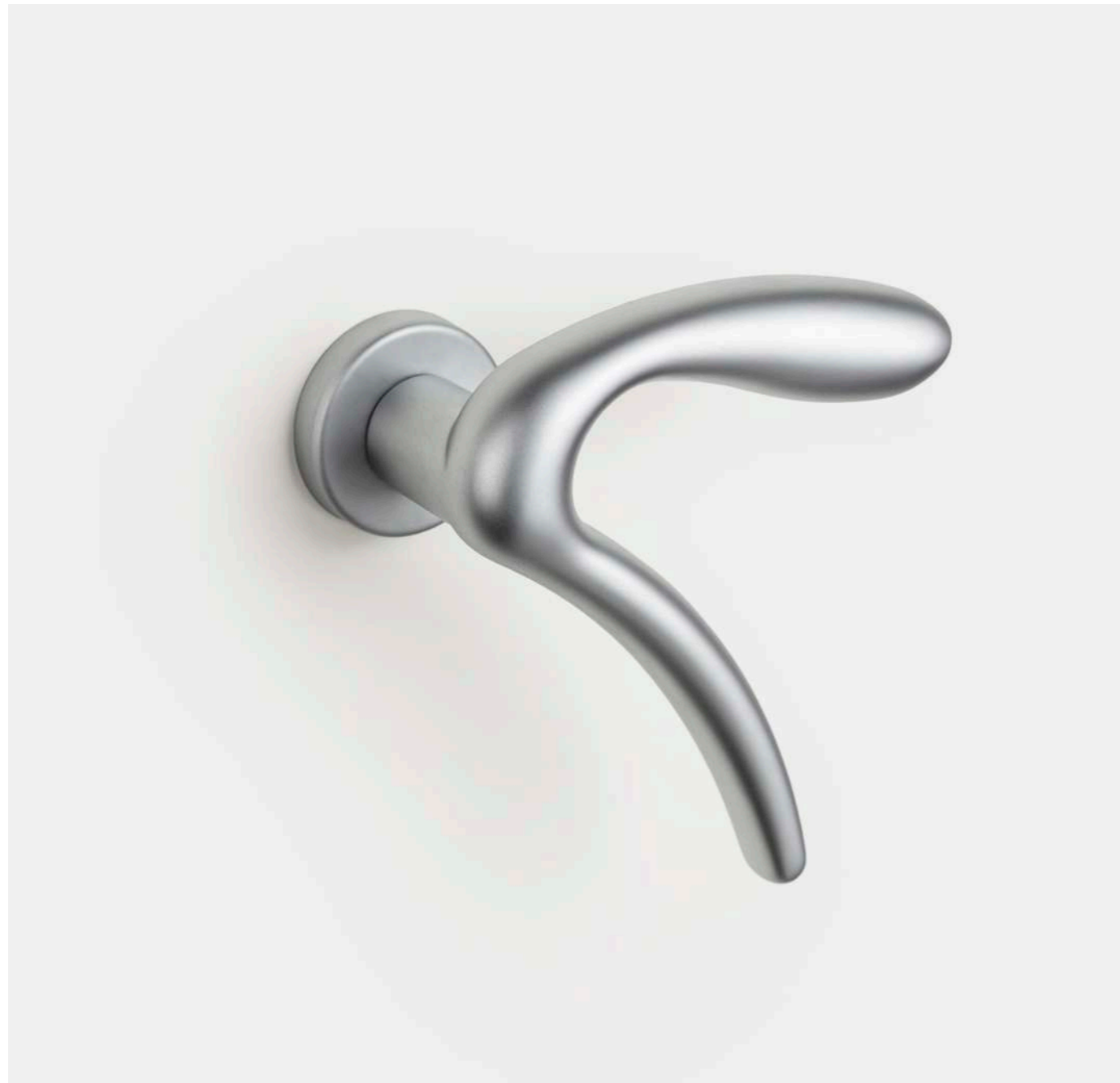

ACL

ANO

ACP



Per istruzioni di montaggio  
scansiona QR code,  
seleziona il numero di  
riferimento e segui le  
istruzioni.  
For assembly instructions  
scan the QR code, select the  
relevant assembly number  
and follow the instructions.

77042

Leonardo

Aluminium

Maniglie

	ACP	ANO	ACL	Conf. Pz.
1 Q8 R Guarnitura Q8 ros. senza bocc. Lever handle 8mm on rose	77042280013 77,38	77042280016 55,95	77042280017 77,38	1
1 Q8 RB Guarnitura Q8 ros./bocc. patent Lever handle 8mm on rose key hole escutcheon	77042281013 88,83	77042281016 66,96	77042281017 88,83	1
1 Q8 RBY Guarnitura Q8 ros./bocc. yale Lever handle 8mm on rose - cyl. hole escutcheon	77042285013 88,83	77042285016 66,96	77042285017 88,83	1
1 Q8 RBWC Guarnitura Q8 ros./bocc. Wc Lever handle 8mm on rose wc hole escutcheon	77042288013 98,95	77042288016 74,85	77042288017 98,95	1
2 Q8 ROC Guarnitura Q8 ros.ovale senza bocc. Lever handle 8mm on oval rose	77042220513 85,11	77042220516 61,60	77042220517 85,11	1
2 Q8 RBOC Guarnitura Q8 ros/boc. ovale patent Lever handle 8mm on oval rose key hole escutcheon	77042221513 97,76	77042221516 73,66	77042221517 97,76	1
2 Q8 RBOYC Guarnitura Q8 ros/boc. ovale Yale Lever handle 8mm on oval rose - cyl. hole escutcheon	77042225513 97,76	77042225516 73,66	77042225517 97,76	1

Il Progetto Leonardo rinnova il rapporto con l'oggetto maniglia indirizzandolo verso un uso ampliato realmente utilizzabile da bambini, adulti, anziani o persone con sedia a ruote. Un disegno semplice e "voluminoso" determina con eleganza le forme della maniglia e consente l'impugnarla a diverse altezze. Una forma innovativa e gradevole risolve i temi dell'accessibilità e della praticità d'uso senza barriere formali o psicologiche.

Design for all = utenza universale

Il mondo della progettazione si è sempre rivolto ad un modello ideale di utente (ipotizzato già negli studi dell'uomo vitruviano di Leonardo e sino in tempi più recenti dal Modulor di Le Corbusier): un uomo di età media, di buona costituzione fisica che non ammette varianti. Il mondo reale invece è abitato da bambini, giovani, adulti ed anziani, pertanto anche senza tener conto di disabilità gravi l'utente reale non è in grado di usufruire a pienamente ed in modo autonomo le strutture ed i prodotti che la società gli offre. L'uomo di Leonardo non è superato ma deve essere integrato seguendo l'evoluzione di una società che è più attenta alle esigenze di un design for all e cioè universale (per tutti gli utenti). Il progetto deve quindi rivolgersi verso un'utenza più ampia per soddisfare senza barriere fisiche o psicologiche le diverse esigenze abitative di una società reale. La normativa vigente in tema di accessibilità prevede che le maniglie delle porte, solitamente applicate dalla produzione di serie a 105 cm, sia collocata ad altezza 90 cm. Con la maniglia Leonardo si ha la possibilità di impugnare la maniglia a diverse altezze.

Dfa Italia (Design for All Italia, membro di EIDD - Design for All Europe) ha assegnato alla maniglia Leonardo il prestigioso marchio di qualità Dfa.

The Leonardo Project takes a new look at our relationship with the handle as an object aimed at a wide range of uses. It really can be used by children, adults, old people and people in wheelchairs. A simple, voluminous design determines the elegant shape of the handle and makes it possible to grip it at different heights. An innovative and pleasing shape answers the need for accessibility and ease of use without formal or psychological barriers.

Dfa Italy (Design for All Italy, member of EIDD - Design for All Europe) has assigned to Leonardo handle the prestigious DFA quality marks for its ability to be used by the largest category of users without placing functional or psychological barriers.

## PORTA

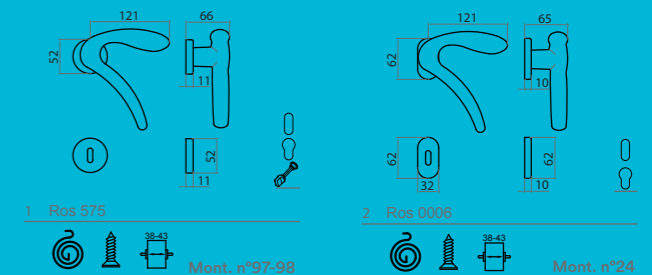

1 Ros 575



Mont. n°97-98

2 Ros 0006



Mont. n°24

# JOLLY 210

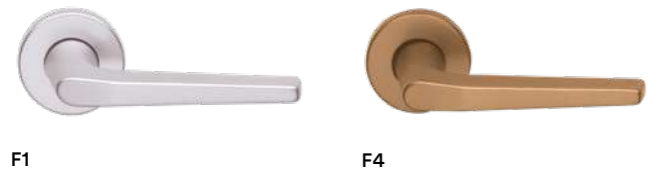

	F1	F3	F4	Conf. Pz.
1 Q8 BIL Coppia maniglie con Q8 (Bilancino) Pair handle with 8mm spindle	70210208001 9,82	70210208003 10,16	70210208004 10,16	10
2 Q8 P90 Guarnitura Q8 placca patent 90 Lever handle 8mm on key plate 90	70210089001 13,39	70210089003 14,52	70210089004 14,52	10
2 Q8 P70 Guarnitura Q8 placca patent 70 Lever handle 8mm on key plate 70	70210087001 13,39	70210087003 14,52	70210087004 14,52	10
2 Q8 PY85 Guarnitura Q8 placca yale 85 Lever handle 8mm on cyl. plate 85	70210088501 13,39	70210088503 14,52	70210088504 14,52	10
3 Q8 R 45 Guarnitura Q8 ros. senza bocc. Lever handle 8mm on rose	70210280001 10,77	70210280003 11,87	70210280004 11,87	10
3 Q8 RB 45 Guarnitura Q8 ros./bocc. patent Lever handle 8mm on rose key hole escutcheon	70210281001 11,72	70210281003 13,58	70210281004 13,58	10
3 Q8 RBY 45 Guarnitura Q8 ros./bocc. yale Lever handle 8mm on rose - cyl. hole escutcheon	70210285001 11,72	70210285003 13,58	70210285004 13,58	10
4 Q8 R 50 Guarnitura Q8 ros. senza bocc. Lever handle 8mm on rose	70210230001 10,90	70210230003 12,00	70210230004 12,00	10
4 Q8 RB 50 Guarnitura Q8 ros./bocc. patent Lever handle 8mm on rose key hole escutcheon	70210231001 12,15	70210231003 14,00	70210231004 14,00	10
4 Q8 RBY 50 Guarnitura Q8 ros./bocc. yale Lever handle 8mm on rose - cyl. hole escutcheon	70210235001 12,15	70210235003 14,00	70210235004 14,00	10
5 Q8 RBWC Q6 50 Guarnitura Q8 ros./bocc. Wc Q6 Lever handle 8mm on wc key hole escutcheon 6mm	70210238001 17,15	70210238003 19,14	70210238004 19,14	10

### PORTA

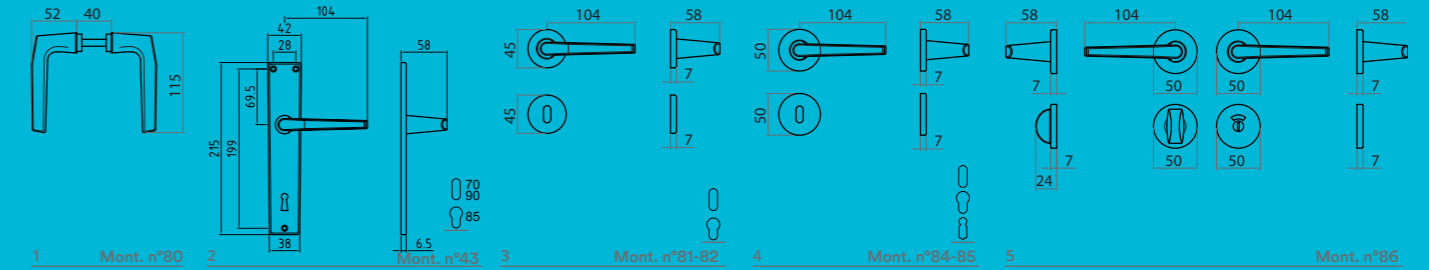

Guarnitura senza molla di ritorno - Handle without spring  
Viti non in dotazione - Screws not provided



Per istruzioni di montaggio  
scansiona QR code,  
seleziona il numero di  
riferimento e segui le  
istruzioni.  
For assembly instructions  
scan the QR code, select the  
relevant assembly number  
and follow the instructions.



# PIGNA 2008

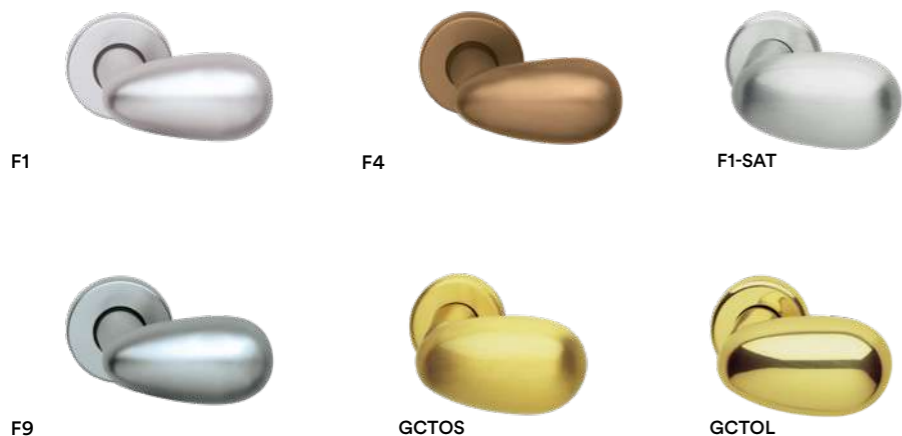

	F1	F3	F4	F9	Conf. Pz.
1 Q8 BIL Coppia maniglie con Q8 (Bilancino) Pair handle with 8mm spindle	72008208001 17,53	72008208003 18,00	72008208004 18,00	72008208009 18,00	10
2 Q8 R 45 Guarnitura Q8 ros. senza bocc. Lever handle 8mm on rose	72008280001 18,48	72008280003 19,72	72008280004 19,72	72008280009 19,72	10
2 Q8 RB 45 Guarnitura Q8 ros./bocc. patent Lever handle 8mm on rose key hole escutcheon	72008281001 19,43	72008281003 21,43	72008281004 21,43	72008281009 21,43	10
2 Q8 RBY 45 Guarnitura Q8 ros./bocc. yale Lever handle 8mm on rose - cyl. hole escutcheon	72008285001 19,43	72008285003 21,43	72008285004 21,43	72008285009 21,43	10
3 Q8 R 50 Guarnitura Q8 ros. senza bocc. Lever handle 8mm on rose	72008230001 18,76	72008230003 19,86	72008230004 19,86	72008230009 19,86	10
3 Q8 RB 50 Guarnitura Q8 ros./bocc. patent Lever handle 8mm on rose key hole escutcheon	72008231001 20,00	72008231003 21,86	72008231004 21,86	72008231009 21,86	10
3 Q8 RBY 50 Guarnitura Q8 ros./bocc. yale Lever handle 8mm on rose - cyl. hole escutcheon	72008235001 20,00	72008235003 21,86	72008235004 21,86	72008235009 21,86	10
4 Q8 RBWC Q6 50 Guarnitura Q8 ros./bocc. Wc Q6 Lever handle 8mm on wc key hole escutcheon 6mm	72008238001 25,00	72008238003 27,00	72008238004 27,00	72008238009 27,00	10

	GCTOL	GCTOS	F1-SAT	Conf. Pz.
2 Q8 R Guarnitura Q8 ros. senza bocc. Lever handle 8mm on rose	77450280012 52,38	77450280023 55,50	77450280033 55,50	1
2 Q8 RB Guarnitura Q8 ros./bocc. patent Lever handle 8mm on rose key hole escutcheon	77450281012 58,48	77450281023 63,54	77450281033 63,54	1
2 Q8 RBY Guarnitura Q8 ros./bocc. yale Lever handle 8mm on rose - cyl. hole escutcheon	77450285012 58,48	77450285023 63,54	77450285033 63,54	1
5 Q8 ROC Guarnitura Q8 ros. ovale senza bocc. Lever handle 8mm on oval rose	77450220512 57,59	77450220523 61,01	77450220533 61,01	1
5 Q8 RBOC Guarnitura Q8 ros./boc. ovale patent Lever handle 8mm on oval rose key hole escutcheon	77450221512 64,43	77450221523 69,94	77450221533 69,94	1
5 Q8 RBOY Guarnitura Q8 ros./boc. ovale yale Lever handle 8mm on oval rose - cyl. hole escutcheon	77450225512 64,43	77450225523 69,94	77450225533 69,94	1

PORTA

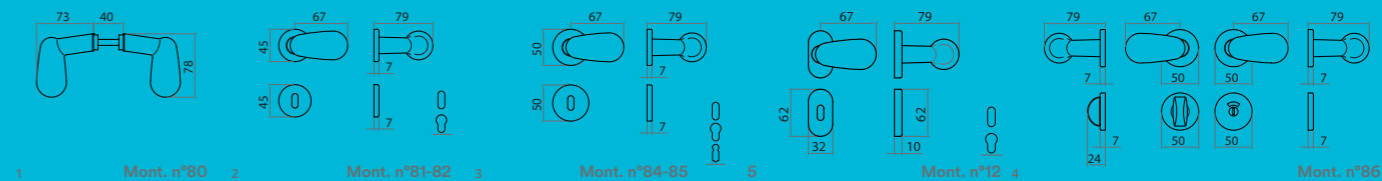

1 Mont. n°80 2 Mont. n°81-82 3 Mont. n°84-85 5 Mont. n°12 4 Mont. n°86



Guarnitura senza molla di ritorno - Handle without spring  
Viti non in dotazione - Screws not provided



Per istruzioni di montaggio  
scansiona QR code,  
seleziona il numero di  
riferimento e segui le  
istruzioni.  
For assembly instructions  
scan the QR code, select the  
relevant assembly number  
and follow the instructions.

# SEVEN



F1



F4



F9



F1

	F1	F3	F4	F9	Conf. Pz.
1 Q8 BIL Coppia maniglie con Q8 (Bilancino) Pair handle with 8mm spindle	77470208001	77470208003	77470208004	77470208009	10
2 Q8 R 45 Guarnitura Q8 ros. senza bocc. Lever handle 8mm on rose	77470280001	77470280003	77470280004	77470280009	10
2 Q8 RB 45 Guarnitura Q8 ros./bocc. patent Lever handle 8mm on rose key hole escutcheon	77470281001	77470281003	77470281004	77470281009	10
2 Q8 RBY 45 Guarnitura Q8 ros./bocc. yale Lever handle 8mm on rose - cyl. hole escutcheon	77470285001	77470285003	77470285004	77470285009	10
3 Q8 R 50 Guarnitura Q8 ros. senza bocc. Lever handle 8mm on rose	77470230001	77470230003	77470230004	77470230009	10
3 Q8 RB 50 Guarnitura Q8 ros./bocc. patent Lever handle 8mm on rose key hole escutcheon	77470231001	77470231003	77470231004	77470231009	10
3 Q8 RBY 50 Guarnitura Q8 ros./bocc. yale Lever handle 8mm on rose - cyl. hole escutcheon	77470235001	77470235003	77470235004	77470235009	10
4 Q8 RBWC Q6 50 Guarnitura Q8 ros./bocc. Wc Q6 Lever handle 8mm on wc key hole escutcheon 6mm	77470238001	77470238003	77470238004	77470238009	10
5 DKx33 8SC BUS. 9,5 SEVEN DKx33 8SC BUS. 9,5 window handle DK x 33mm with pins D.9,5	7747055830158	7747055830358	7747055830458	7747055830958	100
5 DKx35 8SC BUS. 9,5 SEVEN DKx35 8SC BUS. 9,5 window handle DK x 35 mm with pins D.9,5	7747055850158	7747055850358	7747055850458	7747055850958	100
5 DKx40 8SC BUS. 9,5 SEVEN DKx40 8SC BUS. 9,5 window handle DK x 40 mm with pins D.9,5	7747055800158	7747055800358	7747055800458	7747055800958	100
5 DKx45 8SC BUS. 9,5 SEVEN DKx45 8SC BUS. 9,5 window handle DK x 45 mm with pins D.9,5	7747055840158	7747055840358	7747055840458	7747055840958	100

### PORTA

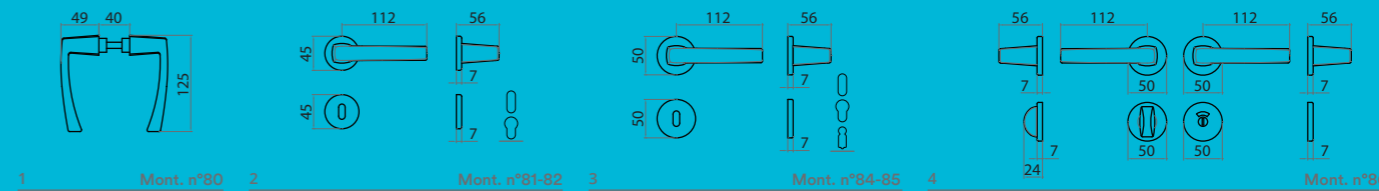

Guarnitura senza molla di ritorno - Handle without spring  
Viti non in dotazione - Screws not provided

### FINESTRA

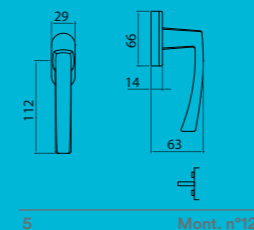

Per istruzioni di montaggio  
scansiona QR code,  
seleziona il numero di  
riferimento e segui le  
istruzioni.  
For assembly instructions  
scan the QR code, select the  
relevant assembly number  
and follow the instructions.

# SEVEN Q



F1

F4

F9



F1

	F1	F3	F4	F9	Conf. Pz.
1 Q8 BIL Coppia maniglie con Q8 (Bilancino) Pair handle with 8mm spindle	77470208001	77470208003	77470208004	77470208009	10
2 Q8 RQ 50 Guarnitura Q8 ros. QUADRA senza bocc. Lever handle 8mm on square rose	77470210301	77470210303	77470210304	77470210309	10
2 Q8 RBQ 50 Guarnitura Q8 ros./bocc. QUADRA patent Lever handle 8mm on square rose key hole escutcheon	77470211301	77470211303	77470211304	77470211309	10
2 Q8 RBQY 50 Guarnitura Q8 ros./bocc. QUADRA Yale Lever handle 8mm on square rose cyl hole escutcheon	77470215301	77470215303	77470215304	77470215309	10
3 Q8 RBQWC Q6 50 Guarnitura Q8 ros./bocc. QUADRA Wc Q6 Lever handle 8mm on square rose wc hole escutcheon 6mm	77470218001	77470218003	77470218004	77470218009	10
4 DK X 33 C/BUSS D.9,5 SEVEN DKX33 8SC RETT C/BUSS D.9,5 window handle DK x 33mm with pins D.9,5	7747055630158	7747055630358	7747055630458	7747055630958	100
4 DK X 35 C/BUSS D.9,5 SEVEN DKX35 8SC RETT C/BUSS D.9,5 window handle DK x 35mm with pins D.9,5	7747055650158	7747055650358	7747055650458	7747055650958	100
4 DK X 40 C/BUSS D.9,5 SEVEN DKX40 8SC RETT C/BUSS D.9,5 window handle DK x 40mm with pins D.9,5	7747055600158	7747055600358	7747055600458	7747055600958	100
4 DK X 45 C/BUSS D.9,5 SEVEN DKX45 8SC RETT C/BUSS D.9,5 window handle DK x 45mm with pins D.9,5	7747055640158	7747055640358	7747055640458	7747055640958	100

### PORTA

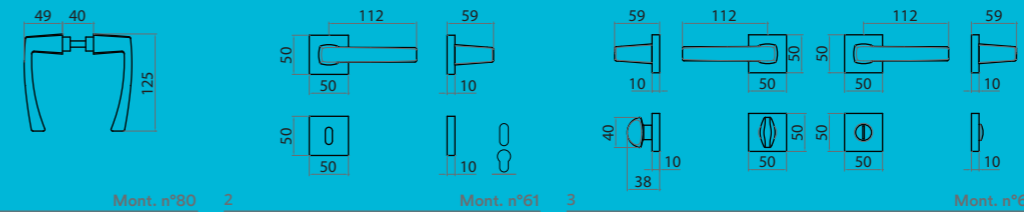

1 Mont. n°80    2 Mont. n°61    3 Mont. n°62

Guarnitura senza molla di ritorno - Handle without spring  
Viti non in dotazione - Screws not provided

### FINESTRA

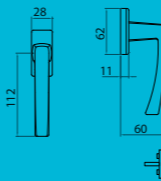

4 Mont. n°10



Per istruzioni di montaggio  
scansiona QR code,  
seleziona il numero di  
riferimento e segui le  
istruzioni.  
For assembly instructions  
scan the QR code, select the  
relevant assembly number  
and follow the instructions.

# SHARK



F1

F4

F9



F1

	F1	F3	F4	F9	Conf. Pz.
1 Q8 BIL Coppia maniglie con Q8 (Bilancino) Pair handle with 8mm spindle	77080208001	77080208003	77080208004	77080208009	10
2 Q8 R 45 Guarnitura Q8 ros. senza bocc. Lever handle 8mm on rose	77080280001	77080280003	77080280004	77080280009	10
2 Q8 RB 45 Guarnitura Q8 ros./bocc. patent Lever handle 8mm on rose key hole escutcheon	77080281001	77080281003	77080281004	77080281009	10
2 Q8 RBY 45 Guarnitura Q8 ros./bocc. yale Lever handle 8mm on rose - cyl. hole escutcheon	77080285001	77080285003	77080285004	77080285009	10
3 Q8 R 50 Guarnitura Q8 ros. senza bocc. Lever handle 8mm on rose	77080230001	77080230003	77080230004	77080230009	10
3 Q8 RB 50 Guarnitura Q8 ros./bocc. patent Lever handle 8mm on rose key hole escutcheon	77080231001	77080231003	77080231004	77080231009	10
3 Q8 RBY 50 Guarnitura Q8 ros./bocc. yale Lever handle 8mm on rose - cyl. hole escutcheon	77080235001	77080235003	77080235004	77080235009	10
4 Q8 RBWC Q6 50 Guarnitura Q8 ros./bocc. Wc Q6 Lever handle 8mm on wc key hole escutcheon 6mm	77080238001	77080238003	77080238004	77080238009	10
5 DKx33 8SC BUS. 9,5 SHARK DKx33 8SC BUS. 9,5 window handle DK x 33mm with pins D.9,5	7708055830158	7708055830358	7708055830458	7708055830958	100
5 DKx35 8SC BUS. 9,5 SHARK DKx35 8SC BUS. 9,5 window handle DK x 35mm with pins D.9,5	7708055850158	7708055850358	7708055850458	7708055850958	100
5 DKx40 8SC BUS. 9,5 SHARK DKx40 8SC BUS. 9,5 window handle DK x 40mm with pins D.9,5	7708055800158	7708055800358	7708055800458	7708055800958	100
5 DKx45 8SC BUS. 9,5 SHARK DKx45 8SC BUS. 9,5 window handle DK x 45mm with pins D.9,5	7708055840158	7708055840358	7708055840458	7708055840958	100
6 DK X 40-35 GHTECH SHARK GHTEK DK40-35 window handle DK x 40mm GHTECH	77080574001	77080574003	77080574004	77080574009	20
6 DK X 40-35 BUS. 9,5 GHTECH SHARK GHTEK DK40-35 BUS. 9,5 window handle DK x 40 mm with pins D.9,5 GHTECH	77080584001	77080584003	77080584004	77080584009	20

### PORTA

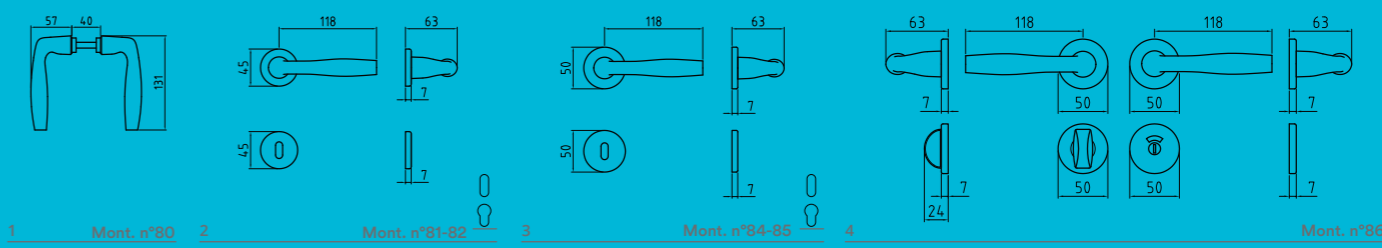

1 Mont. n°80 2 Mont. n°81-82 3 Mont. n°84-85 4 Mont. n°86

**Guarnitura senza molla di ritorno - Handle without spring**  
**Viti non in dotazione - Screws not provided**

### PORTA

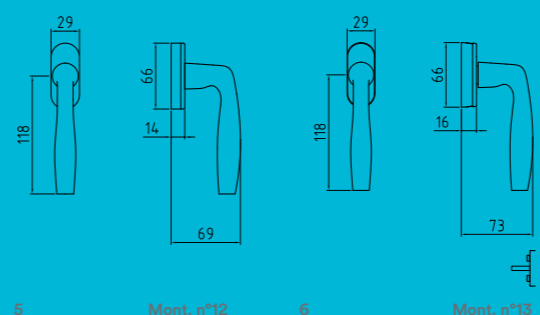

5 Mont. n°12 6 Mont. n°13



Per istruzioni di montaggio  
scansiona QR code,  
seleziona il numero di  
riferimento e segui le  
istruzioni.  
For assembly instructions  
scan the QR code, select the  
relevant assembly number  
and follow the instructions.

# SUSY - 2040



	F1	F3	F4	F9	Conf. Pz.
1 Q8 BIL Coppia maniglie con Q8 (Bilancino) Pair handle with 8mm spindle	72040208001 9,82	72040208003 10,16	72040208004 10,16	72040208009 10,16	10
2 Q8 P90 Guarnitura Q8 placca patent 90 Lever handle 8mm on key plate 90	72040089001 13,42	72040089003 14,38	72040089004 14,38	72040089009 14,38	10
2 Q8 P70 Guarnitura Q8 placca patent 70 Lever handle 8mm on key plate 70	72040087001 13,42	72040087003 14,38	72040087004 14,38	72040087009 14,38	10
2 Q8 PY85 Guarnitura Q8 placca yale 85 Lever handle 8mm on cyl. plate 85	72040088501 13,42	72040088503 14,38	72040088504 14,38	72040088509 14,38	10
2 Q8 R 45 Guarnitura Q8 ros. senza bocc. Lever handle 8mm on rose	72040280001 10,77	72040280003 11,87	72040280004 11,87	72040280009 11,87	10
2 Q8 RB 45 Guarnitura Q8 ros./bocc. patent Lever handle 8mm on rose key hole escutcheon	72040281001 11,72	72040281003 13,58	72040281004 13,58	72040281009 13,58	10
2 Q8 RBY 45 Guarnitura Q8 ros./bocc. yale Lever handle 8mm on rose - cyl. hole escutcheon	72040285001 11,72	72040285003 13,58	72040285004 13,58	72040285009 13,58	10
2 Q8 R 50 Guarnitura Q8 ros. senza bocc. Lever handle 8mm on rose	72040230001 10,90	72040230003 12,00	72040230004 12,00	72040230009 12,00	10
2 Q8 RB 50 Guarnitura Q8 ros./bocc. patent Lever handle 8mm on rose key hole escutcheon	72040231001 12,15	72040231003 14,00	72040231004 14,00	72040231009 14,00	10
2 Q8 RBY 50 Guarnitura Q8 ros./bocc. yale Lever handle 8mm on rose - cyl. hole escutcheon	72040235001 12,15	72040235003 14,00	72040235004 14,00	72040235009 14,00	10
2 Q8 RBWC Q6 50 Guarnitura Q8 ros./bocc. Wc Q6 Lever handle 8mm on wc key hole escutcheon 6mm	72040238001 17,15	72040238003 19,14	72040238004 19,14	72040238009 19,14	10

### PORTA

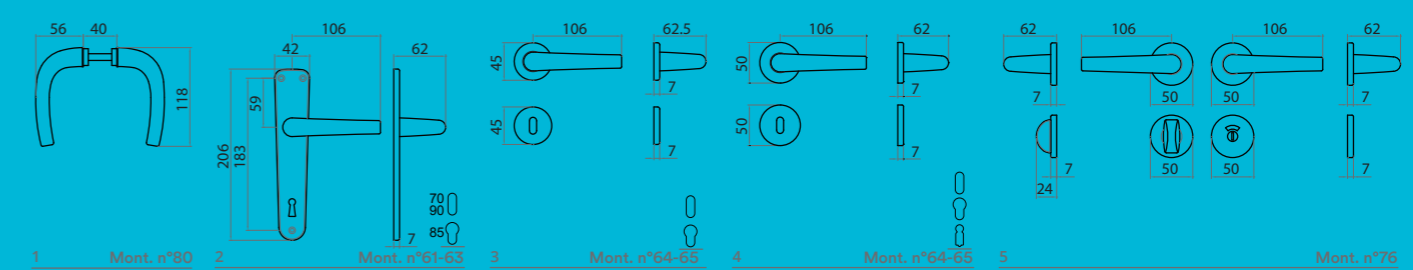

1 Mont. n°80 2 Mont. n°61-63 3 Mont. n°64-65 4 Mont. n°64-65 5 Mont. n°76

Guarnitura senza molla di ritorno - Handle without spring  
Viti non in dotazione - Screws not provided



Per istruzioni di montaggio  
scansiona QR code,  
seleziona il numero di  
riferimento e segui le  
istruzioni.  
For assembly instructions  
scan the QR code, select the  
relevant assembly number  
and follow the instructions.

# UNIVERSAL



F1

F4

F9



F4

	F1	F3	F4	F9	Conf. Pz.
1A Q8 BIL Coppia maniglie con Q8 Pair handle with 8mm spindle	77486208001	77486208003	77486208004	77486208009	10
1B Q8 BIL CB+CA Coppia maniglie collo alto/ collo basso con Q8 special pair of handle for balcony door	77490208001	77490208003	77490208004	77490208009	10
1C Q8 BIL CB Coppia maniglie collo basso con Q8 special pair of handle for balcony door	77488208001	77488208003	77488208004	77488208009	10
2 Q8 P90 Guarnitura Q8 placca patent 90 Lever handle 8mm on key plate 90	77486089001	77486089003	77486089004	77486089009	10
2 Q8 P70 Guarnitura Q8 placca patent 70 Lever handle 8mm on key plate 70	77486087001	77486087003	77486087004	77486087009	10
2 Q8 PY85 Guarnitura Q8 placca yale 85 Lever handle 8mm on cyl. plate 85	77486088501	77486088503	77486088504	77486088509	10
3 Q8 R 45 Guarnitura Q8 ros. senza bocc. Lever handle 8mm on rose	77486280001	77486280003	77486280004	77486280009	10
3 Q8 RB 45 Guarnitura Q8 ros./bocc. patent Lever handle 8mm on rose key hole escutcheon	77486281001	77486281003	77486281004	77486281009	10
3 Q8 RBY 45 Guarnitura Q8 ros./bocc. yale Lever handle 8mm on rose - cyl. hole escutcheon	77486285001	77486285003	77486285004	77486285009	10
4 Q8 R 50 Guarnitura Q8 ros. senza bocc. Lever handle 8mm on rose	77486230001	77486230003	77486230004	77486230009	10
4 Q8 RB 50 Guarnitura Q8 ros./bocc. patent Lever handle 8mm on rose key hole escutcheon	77486231001	77486231003	77486231004	77486231009	10
4 Q8 RBY 50 Guarnitura Q8 ros./bocc. yale Lever handle 8mm on rose - cyl. hole escutcheon	77486235001	77486235003	77486235004	77486235009	10
5 Q8 RBWC Q6 50 Guarnitura Q8 ros./bocc. Wc Q6 Lever handle 8mm on wc key hole escutcheon 6mm	77486238001	77486238003	77486238004	77486238009	10
6 DKx33 8SC BUS. 9,5 UNIVERSAL DKx33 8SC BUS. 9,5 window handle DK x 33mm with pins D.9,5	7748655830158	7748655830358	7748655830458	7748655830958	100
6 DKx35 8SC BUS. 9,5 UNIVERSAL DKx35 8SC BUS. 9,5 window handle DK x 35mm with pins D.9,5	7748655850158	7748655850358	7748655850458	7748655850958	100
6 DKx40 8SC BUS. 9,5 UNIVERSAL DKx40 8SC BUS. 9,5 window handle DK x 40mm with pins D.9,5	7748655800158	7748655800358	7748655800458	7748655800958	100
6 DKx45 8SC BUS. 9,5 UNIVERSAL DKx45 8SC BUS. 9,5 window handle DK x 45mm with pins D.9,5	7748655840158	7748655840358	7748655840458	7748655840958	100

### PORTA

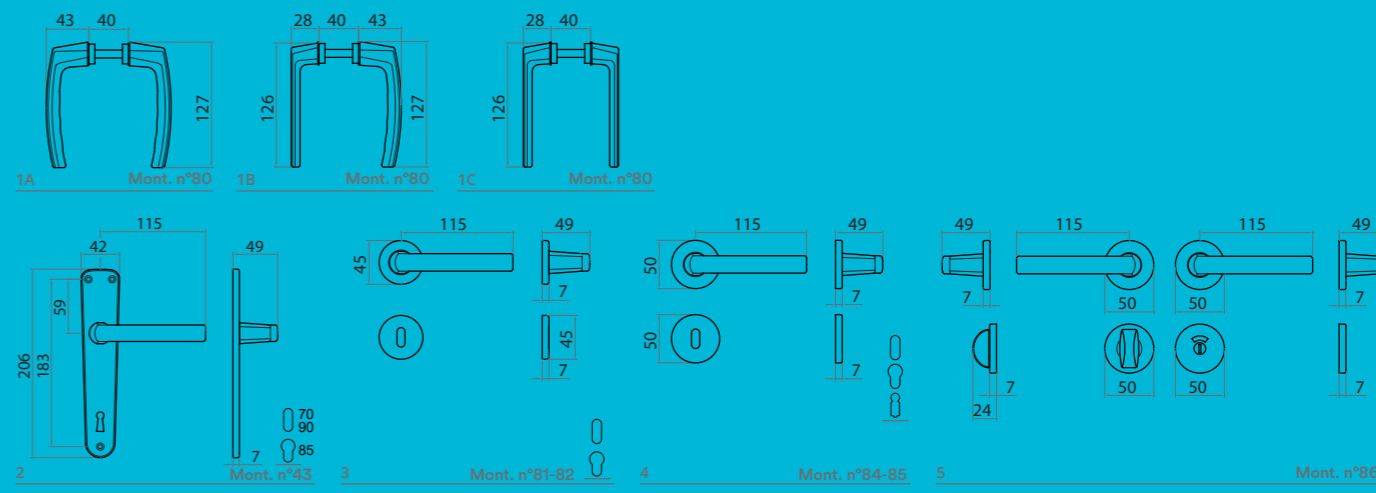

Guarnitura senza molla di ritorno - Handle without spring  
Viti non in dotazione - Screws not provided

### FINESTRA

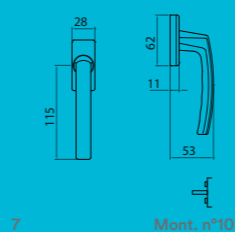

Per istruzioni di montaggio  
scansiona QR code,  
seleziona il numero di  
riferimento e segui le  
istruzioni.  
For assembly instructions  
scan the QR code, select the  
relevant assembly number  
and follow the instructions.

# UNO

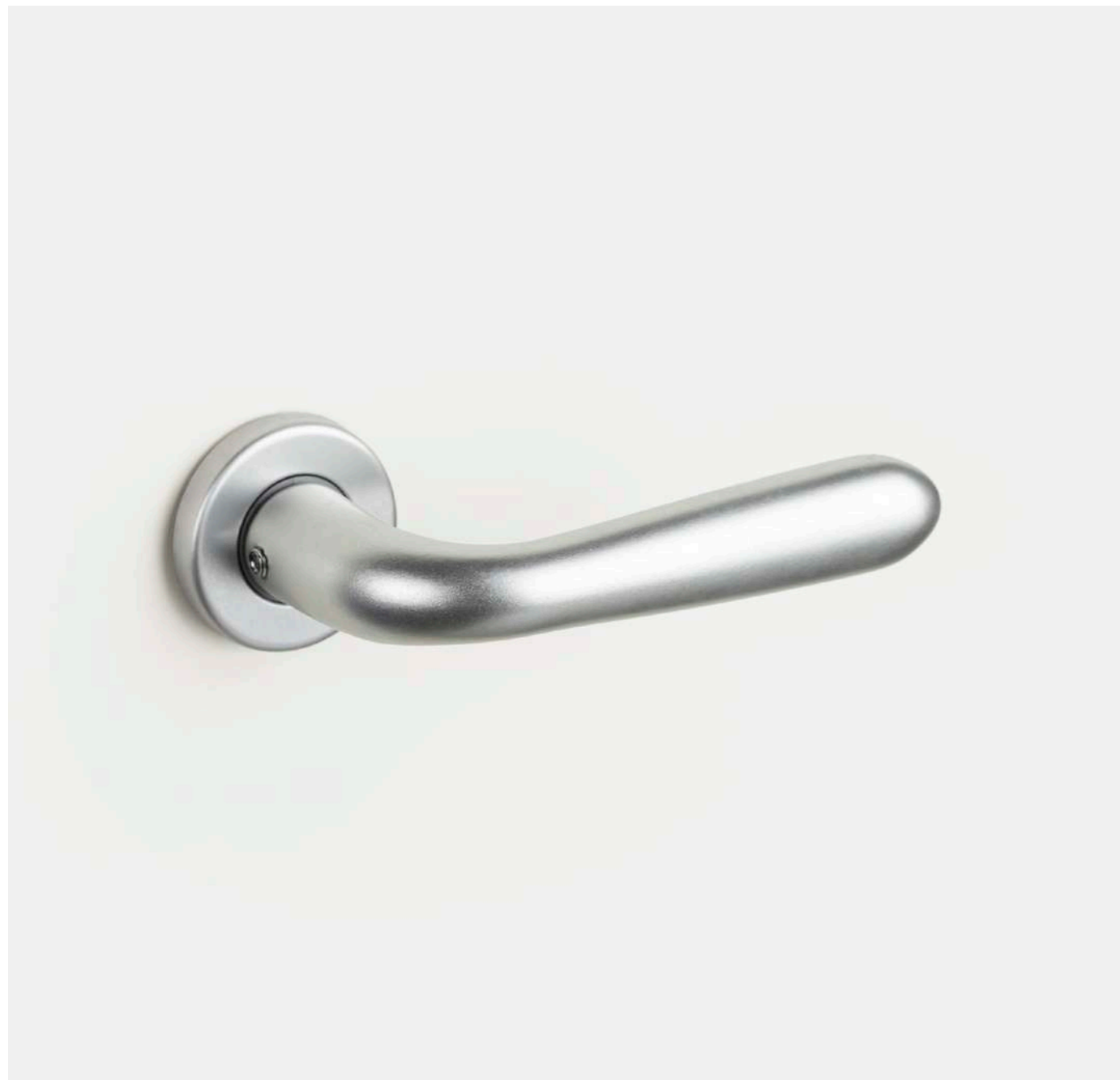

F1

F4

F9

	F1	F3	F4	F9	Conf. Pz.
1 Q8 BIL Coppia maniglie con Q8 (Bilancino) Pair handle with 8mm spindle	77796208001 9,82	77796208003 10,16	77796208004 10,16	77796208009 10,16	10
2 Q8 R 45 Guarnitura Q8 ros. senza bocc. Lever handle 8mm on rose	77796280001 10,77	77796280003 11,87	77796280004 11,87	77796280009 11,87	10
2 Q8 RB 45 Guarnitura Q8 ros./bocc. patent Lever handle 8mm on rose key hole escutcheon	77796281001 11,72	77796281003 13,58	77796281004 13,58	77796281009 13,58	10
2 Q8 RBY 45 Guarnitura Q8 ros./bocc. yale Lever handle 8mm on rose - cyl. hole escutcheon	77796285001 11,72	77796285003 13,58	77796285004 13,58	77796285009 13,58	10
3 Q8 R 50 Guarnitura Q8 ros. senza bocc. Lever handle 8mm on rose	77796230001 10,90	77796230003 12,00	77796230004 12,00	77796230009 12,00	10
3 Q8 RB 50 Guarnitura Q8 ros./bocc. patent Lever handle 8mm on rose key hole escutcheon	77796231001 12,15	77796231003 14,00	77796231004 14,00	77796231009 14,00	10
3 Q8 RBY 50 Guarnitura Q8 ros./bocc. yale Lever handle 8mm on rose - cyl. hole escutcheon	77796235001 12,15	77796235003 14,00	77796235004 14,00	77796235009 14,00	10
4 Q8 RBWC Q6 50 Guarnitura Q8 ros./bocc. Wc Q6 Lever handle 8mm on wc key hole escutcheon 6mm	77796238001 17,15	77796238003 19,14	77796238004 19,14	77796238009 19,14	10

PORTA

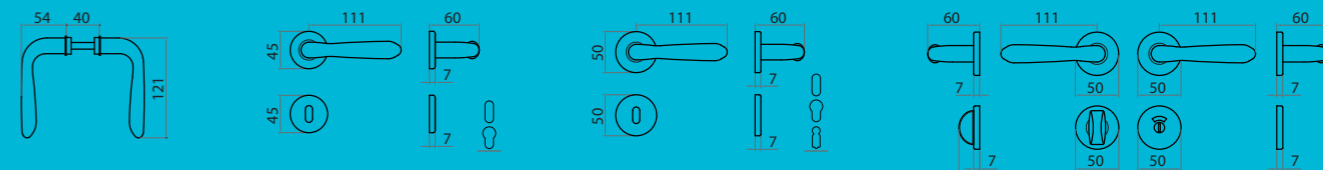

1 Mont. n°80 2 Mont. n°81-82 3 Mont. n°84-85 4 Mont. n°86

Guarnitura senza molla di ritorno - Handle without spring  
Viti non in dotazione - Screws not provided



Per istruzioni di montaggio  
scansiona QR code,  
seleziona il numero di  
riferimento e segui le  
istruzioni.  
For assembly instructions  
scan the QR code, select the  
relevant assembly number  
and follow the instructions.

# 2071



	F1	F3	F4	F9	Conf. Pz.
Q8 BIL	72071208001	72071208003	72071208004	72071208009	
2071 Q8 BIL	15,77	16,65	16,65	16,65	10
Pair handle with 8mm spindle					

PORTA





# 2006 CUORE



	F1	F3	F4	Conf. Pz.
Q8 BIL	72006208001	72006208003	72006208004	
2006 Q8 BIL	12,10	11,00	11,00	10
Pair handle with 8mm spindle				

PORTA

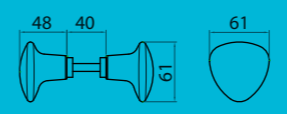

# 2

## Serramenti

## Windows

228 Indice alfabetico serramenti / Alphabetical index windows

230 Alluminio galattico / Galactic Aluminum  
232 Zama / Zamak  
268 Ottone / Brass  
286 Alluminio / Aluminum  
308 Alluminio galattico / Galactic Aluminum  
309 Zama / Zamak  
310 Ottone / Brass  
312 Alluminio / Aluminum

# Indice alfabetico serramenti

141	AL. GALATTICO	231	SEVEN	ALLUMINIO	298
4038	ALLUMINIO	302	SEVEN Q	ZAMA	257
7900	AL. GALATTICO	230	SEVEN Q	ALLUMINIO	299
7900	ALLUMINIO	286	SHARK	ALLUMINIO	300
7900 ALZANTE	AL. GALATTICO	308	SHARK ALZANTE	OTTONE	310
7900 ALZANTE	ALLUMINIO	313	SHARK	ZAMA	258
2005 ITACA	ALLUMINIO	295	SHARK	ZAMA	259
2010 - 3013	ALLUMINIO	304	SWING	ZAMA	260
6008 - 6010	ALLUMINIO	305	TOY	ZAMA	261
ARCHIMEDE	ALLUMINIO	286	TOY Q	ZAMA	261
(BALCONY)	ALLUMINIO	306	UNIVERSAL	ALLUMINIO	301
(BALCONY)	ALLUMINIO	307	UNIVERSALE	ALLUMINIO	303
BAROCCO	OTTONE	268	UNO	OTTONE	284
BRIXIA	ALLUMINIO	288	UNO Z	ZAMA	262
BRIXIA 2	ALLUMINIO	289	VICTORIA	ZAMA	263
CARLO	ALLUMINIO	290	WING	ZAMA	264
CARTER	ZAMA	232	YORK	ZAMA	265
CARTESIO	ZAMA	233	YORK ALZANTE	ZAMA	309
CARTESIO B/W	ZAMA	234	YORK BERRY	ZAMA	266
CARTESIO Q	ZAMA	235	YORK Q	ZAMA	267
CARTESIO Q B/W	ZAMA	236			
CLIP	ZAMA	237			
DELTA	ALLUMINIO	291			
EASY	OTTONE	269			
EASY Q	OTTONE	270			
ELITE	OTTONE	271			
EUROPA ALZANTE	ALLUMINIO	312			
FARFALLA	ZAMA	238			
FERGIE	ZAMA	239			
FLY 24	ALLUMINIO	292			
FLY SCREEN	ALLUMINIO	293			
GABRY	ALLUMINIO	294			
GALILEO	ZAMA	240			
GALILEO Q	ZAMA	241			
GINEVRA	OTTONE	272			
GIOCHI PER CR.	FERRO	285			
GM05	ZAMA	242			
GM07	ZAMA	243			
GM08	ZAMA	244			
GM10	ZAMA	245			
GM11	ZAMA	246			
GOLF	OTTONE	273			
IDEA	ZAMA	247			
IDEA Q	ZAMA	248			
ITACA ALZANTE	ALLUMINIO	314			
KEY	ALLUMINIO	296			
LADY	OTTONE	274			
LEAF	ZAMA	249			
LITZ	ZAMA	250			
MILENA	OTTONE	275			
MILENA ALZANTE	OTTONE	311			
MILENA Z	ZAMA	251			
NION	ZAMA	252			
NION Q	ZAMA	253			
NOVECENTO	OTTONE	276			
PIGNA	OTTONE	277			
R5200	OTTONE	278			
R716	OTTONE	279			
R771	OTTONE	280			
R775	OTTONE	281			
R901	OTTONE	282			
R938	ZAMA	254			
R988	OTTONE	283			
RIALTO	ZAMA	255			
ROOF	ALLUMINIO	297			
SEVEN	ZAMA	256			

# Alphabetical index windows

141	GALACTICAL AL.	231	SEVEN	ALUMINUM	298
4038	ALUMINUM	302	SEVEN Q	ZAMAK	257
7900	GALACTICAL AL.	230	SEVEN Q	ALUMINUM	299
7900	ALUMINUM	286	SHARK	ALUMINUM	300
7900 PULL H.	GALACTICAL AL.	308	SHARK PULL H.	BRASS	310
7900 PULL H.	ALUMINUM	313	SHARK	ZAMAK	258
2005 ITACA	ALUMINUM	295	SHARK	ZAMAK	259
2010 - 3013	ALUMINUM	304	SWING	ZAMAK	260
6008 - 6010	ALUMINUM	305	TOY	ZAMAK	261
ARCHIMEDE	ALUMINUM	287	TOY Q	ZAMAK	261
(BALCONY)	ALUMINUM	306	UNIVERSAL	ALUMINUM	301
(BALCONY)	ALUMINUM	307	UNIVERSALE	ALUMINUM	303
BAROCCO	BRASS	268	UNO	BRASS	284
BRIXIA	ALUMINUM	288	UNO Z	ZAMAK	262
BRIXIA 2	ALUMINUM	289	VICTORIA	ZAMAK	263
CARLO	ALUMINUM	290	WING	ZAMAK	264
CARTER	ZAMAK	232	YORK	ZAMAK	265
CARTESIO	ZAMAK	233	YORK ALZANTE	ZAMAK	309
CARTESIO B/W	ZAMAK	234	YORK BERRY	ZAMAK	266
CARTESIO Q	ZAMAK	235	YORK Q	ZAMAK	267
CARTESIO Q B/W	ZAMAK	236			
CLIP	ZAMAK	237			
DELTA	ALUMINUM	291			
EASY	BRASS	269			
EASY Q	BRASS	270			
ELITE	BRASS	271			
EUROPA PULL H.	ALUMINUM	312			
FARFALLA	ZAMAK	238			
FERGIE	ZAMAK	239			
FLY 24	ALUMINUM	292			
FLY SCREEN	ALUMINUM	293			
GABRY	ALUMINUM	294			
GALILEO	ZAMAK	240			
GALILEO Q	ZAMAK	241			
GINEVRA	BRASS	272			
GIOCHI PER CR.	IRON	285			
GM05	ZAMAK	242			
GM07	ZAMAK	243			
GM08	ZAMAK	244			
GM10	ZAMAK	245			
GM11	ZAMAK	246			
GOLF	BRASS	273			
IDEA	ZAMAK	247			
IDEA Q	ZAMAK	248			
ITACA PULL H.	ALUMINUM	314			
KEY	ALUMINUM	296			
LADY	BRASS	274			
LEAF	ZAMAK	249			
LITZ	ZAMAK	250			
MILENA	BRASS	275			
MILENA PULL H.	BRASS	311			
MILENA Z	ZAMAK	251			
NION	ZAMAK	252			
NION Q	ZAMAK	253			
NOVECENTO	BRASS	276			
PIGNA	BRASS	277			
R5200	BRASS	278			
R716	BRASS	279			
R771	BRASS	280			
R775	BRASS	281			
R901	BRASS	282			
R938	ZAMAK	254			
R988	BRASS	283			
RIALTO	ZAMAK	255			
ROOF	ALUMINUM	297			
SEVEN	ZAMAK	256			

## 7900

ALLUMINIO GALATTICO

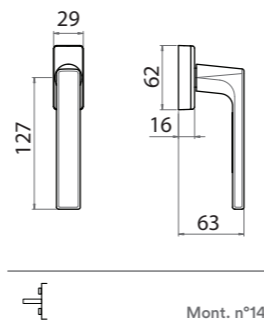

	MERCURY	URANUS	JUPITER	SPACE	Conf. Pz.
1 DK40 BUS, 9,5	77900583033	77900583034	77900583041	77900583076	20
7900 GHTEK DK40 BUS, 9,5	15,25	15,25	15,25	15,25	
window handle DK x 40mm with pins D.9,5					
2 DK45 BUS, 9,5 c/viti	7790058333391	7790058333491	7790058334191	7790058337691	20
7900 GHTEK DK45 BUS, 9,5 c/viti	15,50 ⚡	15,50 ⚡	15,50 ⚡	15,50 ⚡	
window handle DK x 45mm with pins D.9,5 and screws					

⚡ Servizio G48: Articolo a magazzino e disponibile entro 48 dall'elaborazione dell'ordine. In base a disponibilita' e condizioni di vendita.  
G48 service: Item in stock and available within 48 hours of order processing. Based on availability and sales conditions.



Per istruzioni di montaggio scansiona QR code, seleziona il numero di riferimento e segui le istruzioni.  
For assembly instructions scan the QR code, select the relevant assembly number and follow the instructions.

## 141

ALLUMINIO GALATTICO

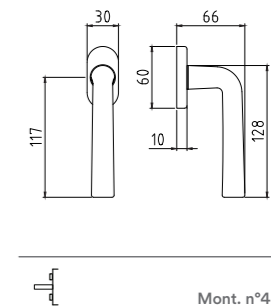

	MERCURY	URANUS	JUPITER	SPACE	Conf. Pz.
1 DK x 40 C/BUSS D.9,5	7014155803395	7014155803495	7014155804195	7014155807695	2
141 DKx40 C/BUSS D.9,5	14,35	14,35	14,35	14,35	
window handle DK x 40 mm with pins D.9,5					
2 DK x 45 C/BUSS D.9,5 C/viti	7014155843395	7014155843495	7014155844195	7014155847695	2
141 DKx45 C/BUSS D.9,5 C/viti	14,65	14,65	14,65	14,65	
window handle DK x 45 mm with pins D.9,5 with screws					



Per istruzioni di montaggio scansiona QR code, seleziona il numero di riferimento e segui le istruzioni.  
For assembly instructions scan the QR code, select the relevant assembly number and follow the instructions.

# CARTER

DESIGN MESSINEO E SETTIMELLI

ZAMA

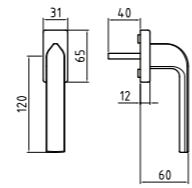

3 **Gioco in ferro**



Mont. n°6

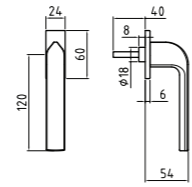

4



Mont. n°7

	ZCL	ZCS	ZNO	Conf. Pz.
3 DK X 40 C/BUSS Martellina DK Q7 x 40 con bussole D. 9,5 gioco in ferro window handle DK x 40mm with pins D.9,5 iron mechanism	66510553807	66510553813	66510553816	2
4 DK X 40 ribassato Martellina DK Q7 x 40 ribassato window handle DK x 40 mm thin mechanism	66510594007	66510594013	66510594016	2



Per istruzioni di montaggio scansiona QR code, seleziona il numero di riferimento e segui le istruzioni.  
For assembly instructions scan the QR code, select the relevant assembly number and follow the instructions.

# CARTESIO

DESIGN FABRIZIO BIANCHETTI

ZAMA

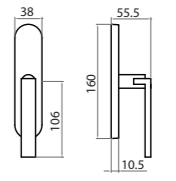

3

Mont. n°140-141

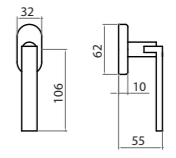

4



Mont. n°4

	ZCL-F1-SAT	Conf. Pz.
3 EZ IM Cremonese gioco EZ imp. maniglia Mechanism for window handle spindle 7 mm	55012456054	2
3 EZQ7 IM Cremonese gioco EZ + Q7 imp. maniglia Mechanism for window handle spindle 7 mm	55012457054	2
3 MART IM Martellina Q7 imp. Maniglia lever window handle	55012550054	2
4 DK X 40 Martellina DK Q7 x 40 window handle DK x 40 mm	55012557054	2
4 DK X 40 C/BUSS Martellina DK Q7 x 40 con bussole D. 9,5 window handle DK x 40mm with pins D.9,5	55012558054	2



Per istruzioni di montaggio scansiona QR code, seleziona il numero di riferimento e segui le istruzioni.  
For assembly instructions scan the QR code, select the relevant assembly number and follow the instructions.

# CARTESIO B/W

DESIGN FABRIZIO BIANCHETTI

ZAMA

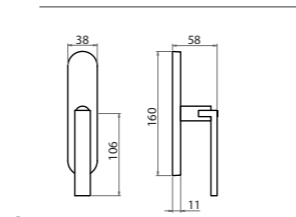

3

Mont. n°140-141

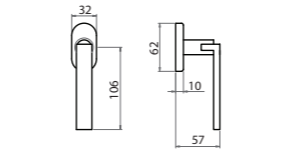

4



Mont. n°4

	ZCL-WHITE	ZCL-BLACK	Conf. Pz.
3 EZ IM Cremonese gioco EZ imp. maniglia Mechanism for window handle spindle 7 mm	55012456077	55012456086	2
	32,74	32,74	
3 EZQ7 IM Cremonese gioco EZ + Q7 imp. maniglia Mechanism for window handle spindle 7 mm	55012457077	55012457086	2
	33,48	33,48	
3 MART IM Martellina Q7 imp. Maniglia lever window handle	55012550077	55012550086	2
	32,74	32,74	
4 DK X 40 Martellina DK Q7 x 40 window handle DK x 40 mm	55012557077	55012557086	2
	31,10	31,10	
4 DK X 40 C/BUSS Martellina DK Q7 x 40 con bussole D. 9,5 window handle DK x 40mm with pins D.9,5	55012558077	55012558086	2
	31,10	31,10	



Per istruzioni di montaggio scansiona QR code, seleziona il numero di riferimento e segui le istruzioni.  
For assembly instructions scan the QR code, select the relevant assembly number and follow the instructions.

# CARTESIO Q

DESIGN FABRIZIO BIANCHETTI

ZAMA

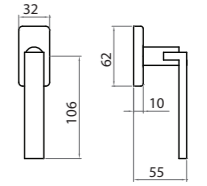

3 DK-1P



Mont. n°6

	ZCL-F1-SAT	Conf. Pz.
3 DK X 40 Martellina DK Q7 x 40 window handle DK x 40 mm	44994557054	2
	31,10	
3 DK X 40 C/BUSS Martellina DK Q7 x 40 con bussole D. 9,5 window handle DK x 40mm with pins D.9,5	44994558054	2
	31,10	



Per istruzioni di montaggio scansiona QR code, seleziona il numero di riferimento e segui le istruzioni.  
For assembly instructions scan the QR code, select the relevant assembly number and follow the instructions.

# CARTESIO Q B/W

DESIGN FABRIZIO BIANCHETTI

ZAMA

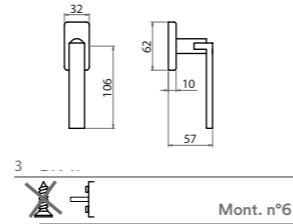

	ZCL-WHITE	ZCL-BLACK	Conf. Pz.
4 DK X 40 Martellina DK Q7 x 40 window handle DK x 40 mm	44994557077	44994557086	2
	31,10	31,10	
4 DK X 40 C/BUSS Martellina DK Q7 x 40 con bussola D. 9,5 window handle DK x 40mm with pins D.9,5	44994558077	44994558086	2
	31,10	31,10	



Per istruzioni di montaggio scansiona QR code, seleziona il numero di riferimento e segui le istruzioni.  
For assembly instructions scan the QR code, select the relevant assembly number and follow the instructions.

# CLIP

DESIGN XXY DESIGN

ZAMA

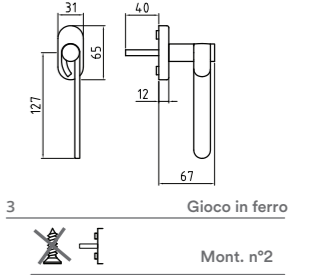

	ZNO-TITANIUM	ZCS-BLACK	ZCL-ZCS	Conf. Pz.
3 DK X 40 C/BUSS Martellina DK Q7 x 40 con bussola D. 9,5 gioco in ferro window handle DK x 40mm with pins D.9,5 iron mechanism	66530549518	66530549521	66530549559	2
	42,59	43,72	48,72	



Per istruzioni di montaggio scansiona QR code, seleziona il numero di riferimento e segui le istruzioni.  
For assembly instructions scan the QR code, select the relevant assembly number and follow the instructions.

# FARFALLA

DESIGN FRANCESCO LUCCHESI

ZAMA

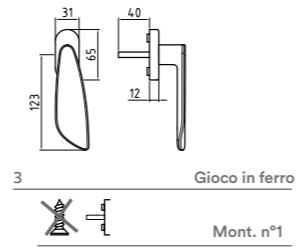

	ZCL	ZCS	ZNO	TITANIUM	Conf. Pz.
3 DK X 40 C/BUSS Martellina DK Q7 x 40 con bussole D. 9,5 gioco in ferro window handle DK x 40mm with pins D.9,5 iron mechanism	66525549507	66525549513	66525549516	66525549554	2
	45,30	40,30	39,17	45,30	



Per istruzioni di montaggio  
scansiona QR code,  
seleziona il numero di  
riferimento e segui le  
istruzioni.  
For assembly instructions  
scan the QR code, select the  
relevant assembly number  
and follow the instructions.

# FERGIE

DESIGN XXY DESIGN

ZAMA

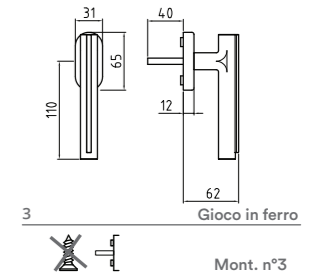

	ZCL	ZCS	ZNO	TITANIUM	Conf. Pz.
3 DK X 40 C/BUSS Martellina DK Q7 x 40 con bussole D. 9,5 gioco in ferro window handle DK x 40mm with pins D.9,5 iron mechanism	66535549507	66535549513	66535549516	66535549554	2
	45,87	40,87	39,74	45,87	



Per istruzioni di montaggio  
scansiona QR code,  
seleziona il numero di  
riferimento e segui le  
istruzioni.  
For assembly instructions  
scan the QR code, select the  
relevant assembly number  
and follow the instructions.



# GALILEO

DESIGN FABRIZIO BIANCHETTI

ZAMA

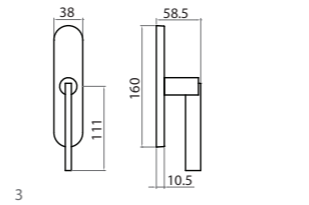

Mont. n°140-141

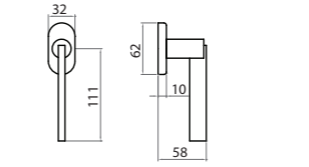

4 DK-1P



Mont. n°4

	ZCL-F1-SAT	Conf. Pz.
3 EZ IM Cremonese gioco EZ imp. maniglia Mechanism for window handle spindle 7 mm	55112456054	2
	32,74	
3 EZQ7 IM Cremonese gioco EZ + Q7 imp. maniglia Mechanism for window handle spindle 7 mm	55112457054	2
	33,48	
3 MART IM Martellina Q7 imp. Maniglia lever window handle	55112550054	2
	32,74	
4 DK X 40 Martellina DK Q7 x 40 window handle DK x 40 mm	55112557054	2
	31,10	
4 DK X 40 C/BUSS Martellina DK Q7 x 40 con bussole D. 9,5 window handle DK x 40mm with pins D.9,5	55112558054	2
	31,10	



Per istruzioni di montaggio scansiona QR code, seleziona il numero di riferimento e segui le istruzioni.  
For assembly instructions scan the QR code, select the relevant assembly number and follow the instructions.

# GALILEO Q

DESIGN FABRIZIO BIANCHETTI

ZAMA

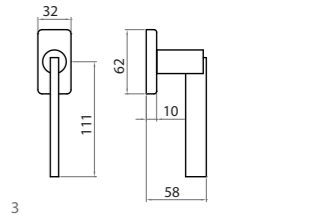

Mont. n°6

	ZCL-F1-SAT	Conf. Pz.
3 DK X 40 Martellina DK Q7 x 40 window handle DK x 40 mm	44996557054	2
	31,10	
3 DK X 40 C/BUSS Martellina DK Q7 x 40 con bussole D. 9,5 window handle DK x 40mm with pins D.9,5	44996558054	2
	31,10	



Per istruzioni di montaggio scansiona QR code, seleziona il numero di riferimento e segui le istruzioni.  
For assembly instructions scan the QR code, select the relevant assembly number and follow the instructions.

# GM05

ZAMA

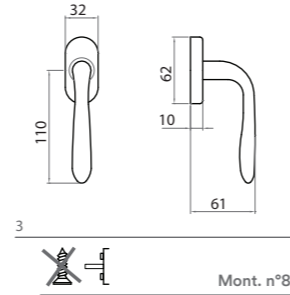

	ZGV	ZCL	GCTOL	ZCS	Conf. Pz.
3 DK X 40 Martellina DK Q7 x 40 window handle DK x 40 mm	6GM58557004	6GM58557007	6GM58557012	6GM58557013	2
	17,38	18,08	14,33	13,08	
3 DK X 40 C/BUSS. Martellina DK Q7 x 40 con bussole D. 9,5 window handle DK x 40mm with pins D.9,5	6GM58558004	6GM58558007	6GM58558012	6GM58558013	2
	13,80	14,50	10,75	9,50	



Per istruzioni di montaggio  
scansiona QR code,  
seleziona il numero di  
riferimento e segui le  
istruzioni.  
For assembly instructions  
scan the QR code, select the  
relevant assembly number  
and follow the instructions.

# GM07

ZAMA

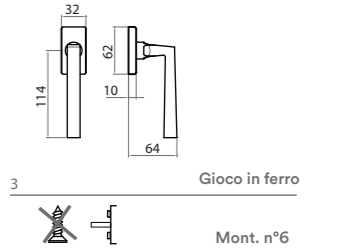

	ZCL	ZCS	Conf. Pz.
3 DK x 40 Martellina DK Q7 x 40 window handle DK x 40 mm	6GM07555007	6GM07555013	2
	23,00	18,00	
3 DK X 40 C/BUS Martellina DK Q7 x 40 con bussole D. 9,5 window handle DK x 40mm with pins D.9,5	6GM07556007	6GM07556013	2
	23,00	18,00	



Per istruzioni di montaggio  
scansiona QR code,  
seleziona il numero di  
riferimento e segui le  
istruzioni.  
For assembly instructions  
scan the QR code, select the  
relevant assembly number  
and follow the instructions.

# GM08

ZAMA

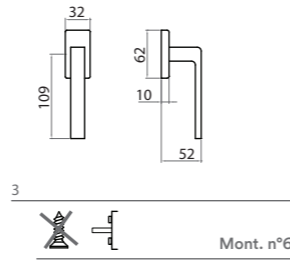

	ZCL	ZCS	Conf. Pz.
3 DK X 40 Martellina DK Q7 x 40 window handle DK x 40 mm	6GM08555007	6GM08555013	2
	25,96	20,96	
3 DK X 40 C/BUSS. Martellina DK Q7 x 40 con bussole D. 9,5 window handle DK x 40mm with pins D.9,5	6GM08556007	6GM08556013	2
	20,14	15,14	



Per istruzioni di montaggio scansiona QR code, seleziona il numero di riferimento e segui le istruzioni.  
For assembly instructions scan the QR code, select the relevant assembly number and follow the instructions.

# GM10

ZAMA

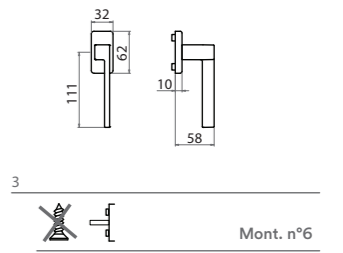

	ZCL	ZCS	ZNO	Conf. Pz.
3 DK X 40 Martellina DK Q7 x 40 window handle DK x 40 mm	6GM10555007	6GM10555013	6GM10555016	2
	28,89	23,89	22,76	
3 DK X 40 C/BUSS. Martellina DK Q7 x 40 con bussole D. 9,5 window handle DK x 40mm with pins D.9,5	6GM10556007	6GM10556013	6GM10556016	2
	28,89	23,89	22,76	



Per istruzioni di montaggio scansiona QR code, seleziona il numero di riferimento e segui le istruzioni.  
For assembly instructions scan the QR code, select the relevant assembly number and follow the instructions.

# GM11

ZAMA

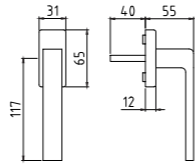

	ZCL	ZCS	Conf. Pz.
3 DK X 40 C/BUSS. Martellina DK Q7 x 40 con bussole D. 9,5 window handle DK x 40mm with pins D.9,5	6GM11553807	6GM11553813	2
	20,28	15,28	



Per istruzioni di montaggio scansiona QR code, seleziona il numero di riferimento e segui le istruzioni.  
For assembly instructions scan the QR code, select the relevant assembly number and follow the instructions.

# IDEA

ZAMA

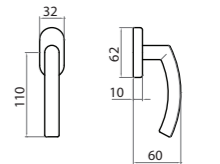
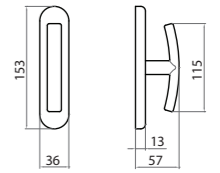

	ZCL	ZCS	ZNS	Conf. Pz.
3 EZ Cremonese gioco EZ Mechanism for window handle spindle 7 mm	66094406007	66094406013	66094406027	2
	33,00	25,00	43,00	
3 EZQ7 Cremonese gioco EZ + Q7 Mechanism for window handle spindle 7 mm	66094407007	66094407013	66094407027	2
	33,59	25,59	41,59	
3 MART Martellina Q7 window handle	66094500007	66094500013	66094500027	2
	33,00	25,00	43,00	
4 DK x 40-35 Martellina DK Q7 x 40-35 window handle DK x 40-35mm	66092577007	66092577013	66092577027	2
	18,84	13,84	23,84	
4 DK x 40-35 C/BUSS Martellina DK Q7 x 40-35 con bussole window handle DK x 40-35 mm with pins D.9,5	66092578007	66092578013	66092578027	2
	18,84	13,84	23,84	



Per istruzioni di montaggio scansiona QR code, seleziona il numero di riferimento e segui le istruzioni.  
For assembly instructions scan the QR code, select the relevant assembly number and follow the instructions.

# IDEA Q

ZAMA

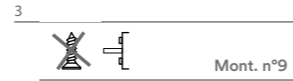
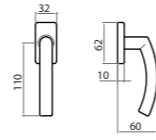

	ZCL	ZCS	ZNS	Conf. Pz.
3 DK x 40-35 Martellina DK Q7 x 40-35 window handle DK x 40-35mm	66080577007	66080577013	66080577027	2
	19,88	14,88	24,88	
3 DK x 40-35 C/BUSS Martellina DK Q7 x 40-35 con bussole window handle DK x 40-35 mm with pins D.9,5	66080578007	66080578013	66080578027	2
	19,88	14,88	24,88	



Per istruzioni di montaggio scansiona QR code, seleziona il numero di riferimento e segui le istruzioni.  
For assembly instructions scan the QR code, select the relevant assembly number and follow the instructions.

# LEAF

DESIGN MESSINEO E SETTIMELLI

ZAMA

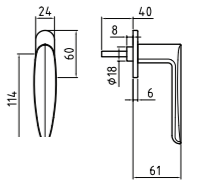
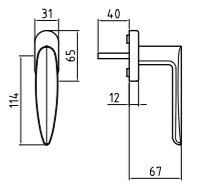

	ZCL	ZCS	ZNO	Conf. Pz.
4 DK X 40 C/BUSS Martellina DK Q7 x 40 con bussole D. 9,5 gioco in ferro window handle DK x 40mm with pins D.9,5 iron mechanism	66505549507	66505549513	66505549516	2
	38,83	33,83	32,70	
5 DK X 40 ribassato Martellina DK Q7 x 40 ribassato window handle DK x 40 mm thin mechanism	66505596007	66505596013	66505596016	2
	38,83	33,83	32,70	



Per istruzioni di montaggio scansiona QR code, seleziona il numero di riferimento e segui le istruzioni.  
For assembly instructions scan the QR code, select the relevant assembly number and follow the instructions.

# LITZ

DESIGN MESSINEO E SETTIMELLI

ZAMA

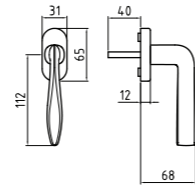

3 | Gioco in ferro



Mont. n°4

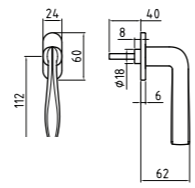

4 | Gioco in ferro



Mont. n°5

	ZCL	ZCS	ZNO	Conf. Pz.
3 DK X 40 C/BUSS Martellina DK Q7 x 40 con bussole D. 9,5 gioco in ferro window handle DK x 40mm with pins D.9,5 iron mechanism	66500549507	66500549513	66500549516	2
	37,10	32,10	30,97	
4 DK X 40 ribassato Martellina DK Q7 x 40 ribassato window handle DK x 40 mm thin mechanism	66500596007	66500596013	66500596016	2
	37,10	32,10	30,97	



Per istruzioni di montaggio scansiona QR code, seleziona il numero di riferimento e segui le istruzioni.  
For assembly instructions scan the QR code, select the relevant assembly number and follow the instructions.

# MILENA Z

ZAMA

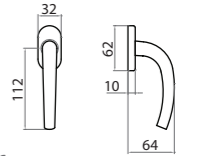

6 | Gioco in ferro

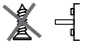

Mont. n°8

	ZCL	GCTOL	ZCS	Conf. Pz.
6 DK X 40 Martellina DK Q7 x 40 window handle DK x 40 mm	66744557007	66744557012	66744557013	2
	17,44	13,69	12,45	
6 DK X 40 C/BUSS. Martellina DK Q7 x 40 con bussole D. 9,5 window handle DK x 40mm with pins D.9,5	66744558007	66744558012	66744558013	2
	17,44	13,69	12,45	



Per istruzioni di montaggio scansiona QR code, seleziona il numero di riferimento e segui le istruzioni.  
For assembly instructions scan the QR code, select the relevant assembly number and follow the instructions.

# NION

ZAMA

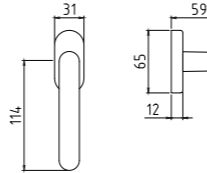
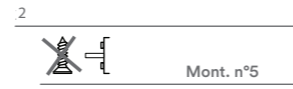
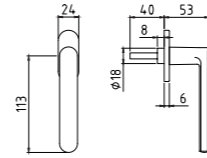

	ZCS	ZNO	Z-BGO	Z-OSO	Conf. Pz.
2 DK X 40 ribassato	R0754596013	R0754596016	R0754596064	R0754596066	2
Martellina DK Q7 x 40 ribassato window handle DK x 40 mm thin mechanism	17,35	15,04	20,22	20,34	
3 DK X 40 C/BUSS	R075400048213	R075400048216	R075400048264	R075400048266	2
Martellina DK Q7 x 40 con bussole D. 9,5 gioco in ferro window handle DK x 40mm with pins D.9,5 iron mechanism	16,43	14,28	20,32	20,44	



Per istruzioni di montaggio scansiona QR code, seleziona il numero di riferimento e segui le istruzioni.  
For assembly instructions scan the QR code, select the relevant assembly number and follow the instructions.

# NION Q

ZAMA



## FINESTRA

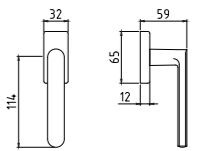
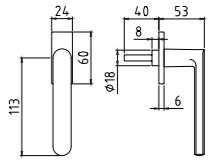

	ZCS	ZNO	Z-BGO	Z-OSO	Conf. Pz.
2 DK X 40 ribassato	R0754594013	R0754594016	R0754594064	R0754594066	2
Martellina DK Q7 x 40 ribassato window handle DK x 40 mm thin mechanism	17,25	14,98	20,13	20,24	
3 DK X 40 C/BUSS	R075400C48213	R075400C48216	R075400C48264	R075400C48266	2
Martellina DK Q7 x 40 con bussole D. 9,5 gioco in ferro window handle DK x 40mm with pins D.9,5 iron mechanism	16,52	14,58	20,59	20,70	



Per istruzioni di montaggio scansiona QR code, seleziona il numero di riferimento e segui le istruzioni.  
For assembly instructions scan the QR code, select the relevant assembly number and follow the instructions.

# R938

ZAMA



## FINESTRA

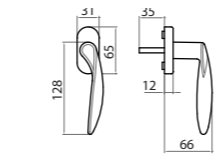

2 DK 4F Gioco in ferro  
 Mont. n°4

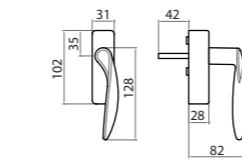

3 RG Mont. n°11  



# RIALTO

DESIGN MESSINEO E SETTIMELLI

ZAMA

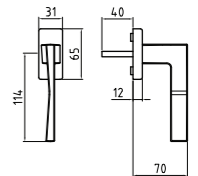

## FINESTRA



3 Gioco in ferro  
 Mont. n°6

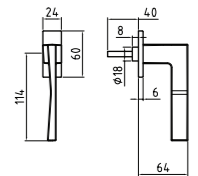

4 Mont. n°7

	ZCL	GCTOL	ZCS	ZNS	Conf. Pz.
4 DK x 35 C/BUSS. Martellina DK Q7x35 c/bussola D.9,5 mm viti metriche window handle DK x 35 mm with pins D.9,5 metric screws	R09380004800790	R09380004801290	R09380004801390	R09380004802790	1
11 DK x 42 C/CHIAVE C/BUSS. Martellina con chiave DK Q7x42 c/bussola D.9,5 mm viti metriche window handle DK x 42mm with key / pins D.9,5 with screws	R093800A4840790	R093800A4841290	R093800A4841390	R093800A4842790	1

	ZCL	ZCS	ZNO	Conf. Pz.
6 DK X 40 C/BUSS Martellina DK Q7 x 40 con bussola D. 9,5 gioco in ferro window handle DK x 40mm with pins D.9,5 iron mechanism	66515553807	66515553813	66515553816	2
7 DK X 40 ribassato Martellina DK Q7 x 40 ribassato window handle DK x 40 mm thin mechanism	66515594007	66515594013	66515594016	2



Per istruzioni di montaggio scansiona QR code, seleziona il numero di riferimento e segui le istruzioni.  
 For assembly instructions scan the QR code, select the relevant assembly number and follow the instructions.



Per istruzioni di montaggio scansiona QR code, seleziona il numero di riferimento e segui le istruzioni.  
 For assembly instructions scan the QR code, select the relevant assembly number and follow the instructions.



# SEVEN

ZAMA

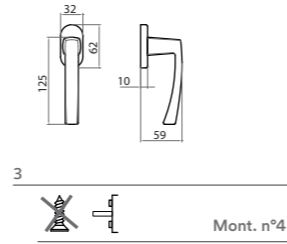

	ZCL	GCTOL	ZCS	ZNS	Conf. Pz.
3 DK x 40 Martellina DK Q7x40 window handle DK x 40 mm	66470557007	66470557012	66470557013	66470557027	2
	25,09	21,34	20,09	30,09	
3 DK X 40 C/BUSS. Martellina DK Q7 x 40 con bussole D.9,5 mm window handle DK x 40mm with pins D.9,5	66470558007	66470558012	66470558013	66470558027	2
	25,09	21,34	20,09	30,09	



Per istruzioni di montaggio  
scansiona QR code,  
seleziona il numero di  
riferimento e segui le  
istruzioni.  
For assembly instructions  
scan the QR code, select the  
relevant assembly number  
and follow the instructions.

# SEVEN Q

ZAMA

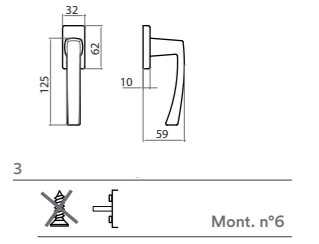

	ZCL	GCTOL	ZCS	ZNS	Conf. Pz.
3 DK x 40 Martellina DK Q7 x 40 window handle DK x 40 mm	66470555007	66470555012	66470555013	66470555027	2
	26,87	23,12	21,87	31,87	
3 DK X 40 C/BUSS. Martellina DK Q7 x 40 con bussole D.9,5 mm window handle DK x 40mm with pins D.9,5	66470556007	66470556012	66470556013	66470556027	2
	26,87	23,12	21,87	31,87	



Per istruzioni di montaggio  
scansiona QR code,  
seleziona il numero di  
riferimento e segui le  
istruzioni.  
For assembly instructions  
scan the QR code, select the  
relevant assembly number  
and follow the instructions.

# SHARK

ZAMA

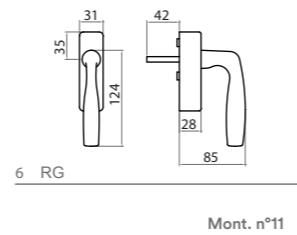
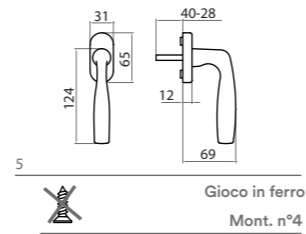
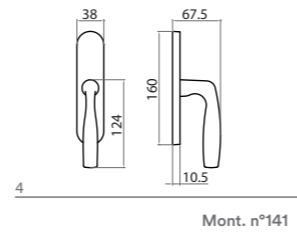

	ZCL	GCTOL	ZCS	ZNS	Conf. Pz.
4 MART IM Martellina Q7 imp. Maniglia lever window handle	66480550007 45,20	66480550012 39,20	66480550013 37,20	66480550027 53,20	2
5 DK x 40 C/BUSS 4 scatti Martellina DK Q7 x 40 c/bussole D.9,5 window handle DK x 40 mm with pins D.9,5	66480549507 23,76	66480549512 20,01	66480549513 18,76	66480549527 28,76	2
5 DK x 40 C/BUSS 8 scatti Martellina DK Q7 x 40 c/bussole D.9,5 window handle DK x 40 mm with pins D.9,5	6648054950708 31,03	6648054951208 27,28	6648054951308 26,03	6648054952708 36,03	2
6 DK x 42 C/CHIAVE C/BUSS. Martellina con chiave DK Q7x42 c/bussole D.9,5 window handle DK x 42mm with key / pins D.9,5	66480563507 111,69	66480563512 107,94	66480563513 106,69	66480563527 116,69	1



Per istruzioni di montaggio scansiona QR code, seleziona il numero di riferimento e segui le istruzioni.  
For assembly instructions scan the QR code, select the relevant assembly number and follow the instructions.

# SWING

DESIGN FRANCESCO LUCCHESI

ZAMA

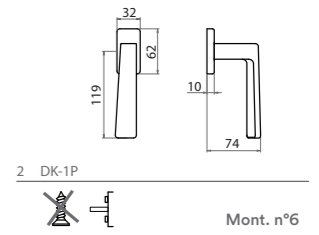

	ZCL	ZCS	ZNO	Conf. Pz.
2 DK X 40 Martellina DK Q7 x 40 window handle DK x 40 mm	66410555007 26,43	66410555013 21,43	66410555016 20,30	2
2 DK X 40 C/BUSS. Martellina DK Q7 x 40 con bussola D. 9,5 window handle DK x 40mm with pins D.9,5	66410556007 26,43	66410556013 21,43	66410556016 20,30	2



Per istruzioni di montaggio scansiona QR code, seleziona il numero di riferimento e segui le istruzioni.  
For assembly instructions scan the QR code, select the relevant assembly number and follow the instructions.

## TOY

ZAMA



## FINESTRA

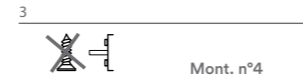
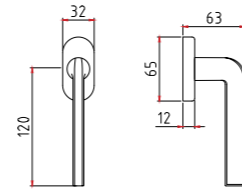
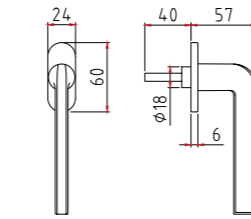

	ZCS	ZNO	Z-BGO	Z-OSO	Conf. Pz.
2 DK X 40 ribassato Martellina DK Q7 x 40 ribassato window handle DK x 40 mm thin mechanism	R0753596013	R0753596016	R0753596064	R0753596066	2
	17,35	15,04	20,22	20,34	
3 DK X 40 C/BUSS Martellina DK Q7 x 40 con bussole D. 9,5 gioco in ferro window handle DK x 40mm with pins D.9,5 iron mechanism	R075300048213	R075300048216	R075300048264	R075300048266	2
	16,43	14,28	20,32	20,44	



Per istruzioni di montaggio scansiona QR code, seleziona il numero di riferimento e segui le istruzioni.  
For assembly instructions scan the QR code, select the relevant assembly number and follow the instructions.

## TOY Q

ZAMA



## FINESTRA

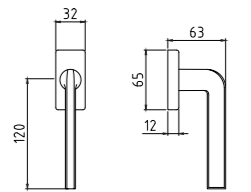
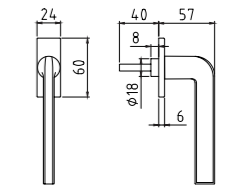

	ZCS	ZNO	Z-BGO	Z-OSO	Conf. Pz.
2 DK X 40 ribassato Martellina DK Q7 x 40 ribassato window handle DK x 40 mm thin mechanism	R0753594013	R0753594016	R0753594064	R0753594066	2
	17,25	14,98	20,13	20,24	
3 DK X 40 C/BUSS Martellina DK Q7 x 40 con bussole D. 9,5 gioco in ferro window handle DK x 40mm with pins D.9,5 iron mechanism	R075300C48213	R075300C48216	R075300C48264	R075300C48266	2
	16,52	14,58	20,59	20,70	



Per istruzioni di montaggio scansiona QR code, seleziona il numero di riferimento e segui le istruzioni.  
For assembly instructions scan the QR code, select the relevant assembly number and follow the instructions.

# UNO Z

ZAMA

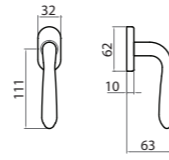

2 DK-2P



Mont. n°8

	ZCL	GCTOL	ZCS	ZNO	ZNS	Conf. Pz.
2 DK X 40 Martellina DK Q7 x 40 window handle DK x 40 mm	66546557007	66546557012	66546557013	66546557016	66546557027	2
	18,05	14,30	13,05	11,92	23,05	
2 DK X 40 C/BUSS. Martellina DK Q7 x 40 con bussole D. 9,5 window handle DK x 40mm with pins D.9,5	66546558007	66546558012	66546558013	66546558016	66546558027	2
	18,05	14,30	13,05	11,92	23,05	



Per istruzioni di montaggio  
scansiona QR code,  
seleziona il numero di  
riferimento e segui le  
istruzioni.  
For assembly instructions  
scan the QR code, select the  
relevant assembly number  
and follow the instructions.

# VICTORIA

ZAMA

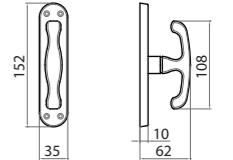

5

Mont. n°146

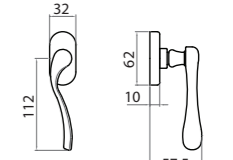

6



Mont. n°4

	GCTOL	OLV	ZGV	OGV	Conf. Pz.
5 MART Martellina Q7 window handle		55010500001		55010500004	2
		31,83		26,93	
6 DK X 40 Martellina DK Q7 x 40 window handle DK x 40 mm	66246557012		66246557004		2
	21,87		24,92		
6 DK X 40 C/BUSS. Martellina DK Q7 x 40 con bussole D. 9,5 window handle DK x 40mm with pins D.9,5	66246558012		66246558004		2
	21,87		24,92		



Per istruzioni di montaggio  
scansiona QR code,  
seleziona il numero di  
riferimento e segui le  
istruzioni.  
For assembly instructions  
scan the QR code, select the  
relevant assembly number  
and follow the instructions.

# WING

ALLUMINIO

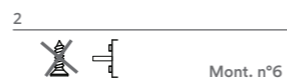
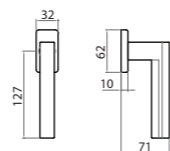

	ACS	ACL	Conf. Pz.
2 DK x 40 Martellina DK Q7 x 40 window handle DK x 40 mm	77792555013	77792555017	2
	51,04	51,04	



Per istruzioni di montaggio scansiona QR code, seleziona il numero di riferimento e segui le istruzioni.  
For assembly instructions scan the QR code, select the relevant assembly number and follow the instructions.

# YORK

ZAMA

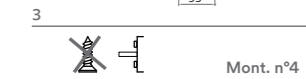
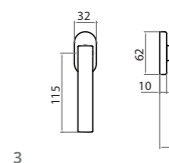

	ZCL	ZCS	ZNS	Conf. Pz.
3 DK X 40 Martellina DK Q7 x 40 window handle DK x 40 mm	66460567007	66460567013	66460567027	2
	24,64	19,64	29,64	
3 DK X 40 C/BUSS. Martellina DK Q7 x 40 con bussola D. 9,5 window handle DK x 40mm with pins D.9,5	66460568007	66460568013	66460568027	2
	24,64	19,64	29,64	



Per istruzioni di montaggio scansiona QR code, seleziona il numero di riferimento e segui le istruzioni.  
For assembly instructions scan the QR code, select the relevant assembly number and follow the instructions.

# YORK BERRY

ZAMA

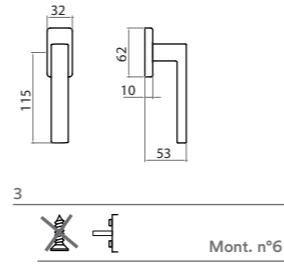

	CHAMPAGNE	NORMANDIA	LORENA	BORGOGNA	Conf. Pz.
3 DK X 40 Martellina DK Q7 x 40 window handle DK x 40 mm	66460557043	66460557044	66460557046	66460557047	2
	33,73	31,00	31,00	31,00	
3 DK X 40 C/BUSS. Martellina DK Q7 x 40 con bussole D. 9,5 window handle DK x 40mm with pins D.9,5	66460558043	66460558044	66460558046	66460558047	2
	33,73	31,00	31,00	31,00	



Per istruzioni di montaggio  
scansiona QR code,  
seleziona il numero di  
riferimento e segui le  
istruzioni.  
For assembly instructions  
scan the QR code, select the  
relevant assembly number  
and follow the instructions.

# YORK Q

ZAMA

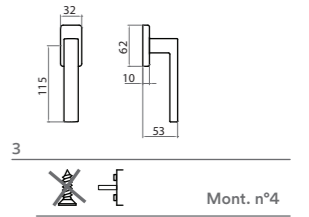

	ZCL	ZCS	ZNO	ZNS	Conf. Pz.
3 DK X 40 Martellina DK Q7 x 40 window handle DK x 40 mm	66460557007	66460557013	66460557016	66460557027	2
	26,43	21,43	20,30	31,43	
3 DK X 40 C/BUSS. Martellina DK Q7 x 40 con bussole D. 9,5 window handle DK x 40mm with pins D.9,5	66460558007	66460558013	66460558016	66460558027	2
	23,01	18,01	16,88	28,01	



Per istruzioni di montaggio  
scansiona QR code,  
seleziona il numero di  
riferimento e segui le  
istruzioni.  
For assembly instructions  
scan the QR code, select the  
relevant assembly number  
and follow the instructions.

# BAROCCO

OTTONE

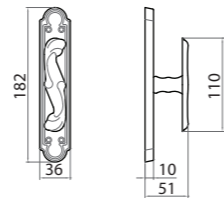

2  
Mont. n°147

	OBR	Conf. Pz.
2 GZ Cremonese gioco GZ Mechanism for window handle spindle 7 mm	44290401000 24,25	10
2 GZP Cremonese gioco GZ + PERNI Mechanism for window handle spindle 7 mm	44290402000 24,85	10
2 GZQ7 Cremonese gioco GZ + Q7 Mechanism for window handle spindle 7 mm	44290403000 24,85	10
2 MART Martellina Q7 window handle	44290500000 23,21	10



Per istruzioni di montaggio scansiona QR code, seleziona il numero di riferimento e segui le istruzioni.  
For assembly instructions scan the QR code, select the relevant assembly number and follow the instructions.

# EASY

OTTONE

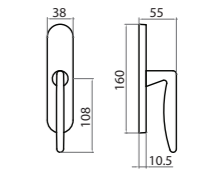

3  
Mont. n°140-141

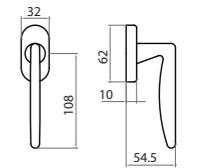

4  
Mont. n°8

	OLV	OCS	OCL	Conf. Pz.
3 EZ IM Cremonese gioco EZ imp. maniglia Mechanism for window handle spindle 7 mm	55014456001 45,75	55014456003 43,75	55014456007 51,75	2
3 EZQ7 IM Cremonese gioco EZ + Q7 imp. maniglia Mechanism for window handle spindle 7 mm	55014457001 47,38	55014457003 45,38	55014457007 53,38	2
3 MART IM Martellina Q7 imp. Maniglia lever window handle	55014550001 47,38	55014550003 45,38	55014550007 53,38	2
4 DK X 40 Martellina DK Q7 x 40 window handle DK x 40 mm	55014557001 35,62	55014557003 34,37	55014557007 39,37	2
4 DK X 40 C/BUSS Martellina DK Q7 x 40 con bussole D. 9,5 window handle DK x 40mm with pins D.9,5	55014558001 35,62	55014558003 34,37	55014558007 39,37	2



Per istruzioni di montaggio scansiona QR code, seleziona il numero di riferimento e segui le istruzioni.  
For assembly instructions scan the QR code, select the relevant assembly number and follow the instructions.

# EASY Q

OTTONE

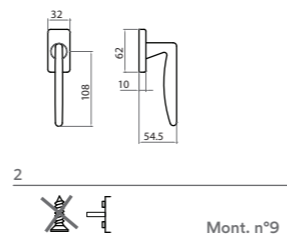

	OLV	OCS	OCL	Conf. Pz.
2 DK X 40-35 Martellina DK Q7 x 40 window handle DK x 40 mm	55062557001	55062557003	55062557007	2
	37,26	36,01	41,01	
2 DK X 40-35 C/BUSS. Martellina DK Q7 x 40 con bussole D. 9,5 window handle DK x 40mm with pins D.9,5	55062558001	55062558003	55062558007	2
	37,26	36,01	41,01	



Per istruzioni di montaggio scansiona QR code, seleziona il numero di riferimento e segui le istruzioni.  
For assembly instructions scan the QR code, select the relevant assembly number and follow the instructions.

# ELITE

OTTONE

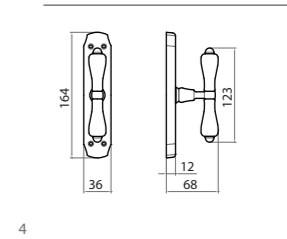

	OBR	OLV	OLD	Conf. Pz.
4 MART Martellina Q7 window handle	55194500000	55194500001	55194500028	2
	44,48	39,58	39,58	
5 DK X 40 Martellina DK Q7 x 40 window handle DK x 40 mm	55194557000	55194557001	55194557028	2
	45,01	41,96	41,96	
5 DK X 40 C/BUSS. Martellina DK Q7 x 40 con bussole D. 9,5 window handle DK x 40mm with pins D.9,5	55194558000	55194558001	55194558028	2
	45,01	41,96	41,96	



Per istruzioni di montaggio scansiona QR code, seleziona il numero di riferimento e segui le istruzioni.  
For assembly instructions scan the QR code, select the relevant assembly number and follow the instructions.



# GINEVRA

OTTONE

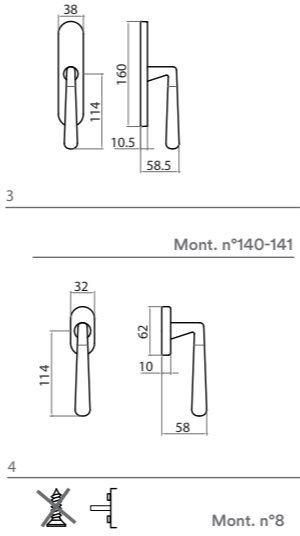

	OLS	OCL/OCS	Conf. Pz.
3 EZ IM Cremonese gioco EZ imp. maniglia Mechanism for window handle spindle 7 mm	55846456002 40,77	5584645600703 38,54	2
3 EZQ7 IM Cremonese gioco EZ + Q7 imp. maniglia Mechanism for window handle spindle 7 mm	55846457002 41,37	5584645700703 39,13	2
3 MART IM Martellina Q7 imp. Maniglia lever window handle	55846550002 40,77	5584655000703 38,54	2
4 DK x 40-35 Martellina DK Q7 x 40 window handle DK x 40 mm	55846557002 40,77	5584655700703 31,55	2
4 DK x 40-35 C/BUSS. Martellina DK Q7 x 40 con bussole D. 9,5 window handle DK x 40mm with pins D.9,5	55846558002 40,77	5584655800703 31,55	2



# GOLF

OTTONE

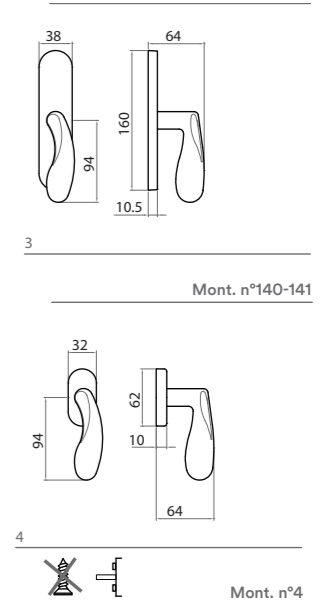

	OLV	OCS	OCL	Conf. Pz.
3 EZ IM Cremonese gioco EZ imp. maniglia Mechanism for window handle spindle 7 mm	55146456001 87,41	55146456003 85,41	55146456007 93,41	2
3 EZQ7 IM Cremonese gioco EZ + Q7 imp. maniglia Mechanism for window handle spindle 7 mm	55146457001 88,01	55146457003 86,01	55146457007 94,01	2
3 MART IM Martellina Q7 imp. Maniglia lever window handle	55146550001 87,41	55146550003 85,41	55146550007 93,41	2
4 DK X 40 Martellina DK Q7 x 40 window handle DK x 40 mm	55146557001 86,66	55146557003 85,41	55146557007 90,41	2

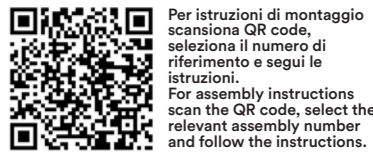

# LADY

OTTONE

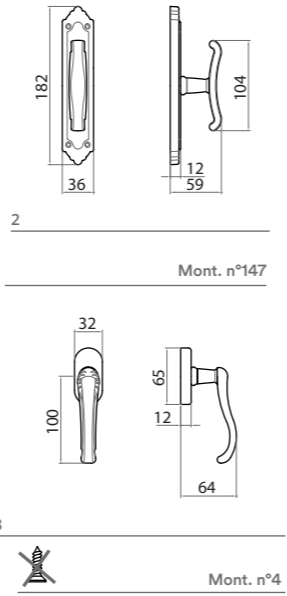

	OF	Conf. Pz.
2 GZ Cremonese gioco GZ Mechanism for window handle spindle 7 mm	44394401006 21,43	6
2 GZP Cremonese gioco GZ + PERNI Mechanism for window handle spindle 7 mm	44394402006 22,17	6
2 GZQ7 Cremonese gioco GZ + Q7 Mechanism for window handle spindle 7 mm	44394403006 22,17	6
3 MART Martellina Q7 window handle	44394500006 20,53	6
3 DK x 40 Martellina DK Q7 x 40 window handle DK x 40 mm	44394555006 21,43	2



Per istruzioni di montaggio scansiona QR code, seleziona il numero di riferimento e segui le istruzioni.  
For assembly instructions scan the QR code, select the relevant assembly number and follow the instructions.

# MILENA

OTTONE

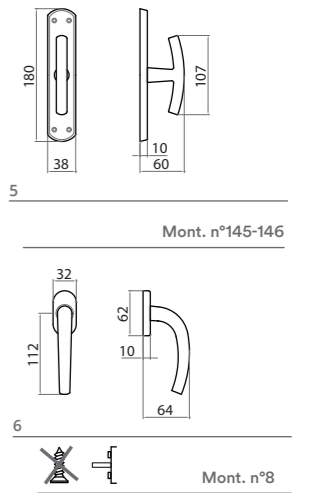

	OLV	OCS	OGV	OCL	OS	Conf. Pz.
5 EZ Cremonese gioco EZ Mechanism for window handle spindle 7 mm	55744406001 29,86	55744406003 27,86	55744406004 34,76	55744406007 35,86	55744406008 29,86	2
5 EZQ7 Cremonese gioco EZ + Q7 Mechanism for window handle spindle 7 mm	55744407001 30,60	55744407003 28,60	55744407004 35,50	55744407007 36,60	55744407008 30,60	2
5 MART Martellina Q7 window handle	55744500001 25,48	55744500003 23,48	55744500004 30,38	55744500007 31,48	55744500008 25,48	2
6 DK x 40-35 Martellina DK Q7 x 40-35 window handle DK x 40-35mm	55744577001 24,94	55744577003 23,69	55744577004 27,99	55744577007 28,69	55744577008 24,94	2
6 DK x 40-35 C/BUSS Martellina DK Q7 x 40-35 con bussole window handle DK x 40-35 mm with pins D.9,5	55744578001 21,56	55744578003 20,31	55744578004 24,61	55744578007 25,31	55744578008 21,56	2



Per istruzioni di montaggio scansiona QR code, seleziona il numero di riferimento e segui le istruzioni.  
For assembly instructions scan the QR code, select the relevant assembly number and follow the instructions.

# NOVECENTO

OTTONE

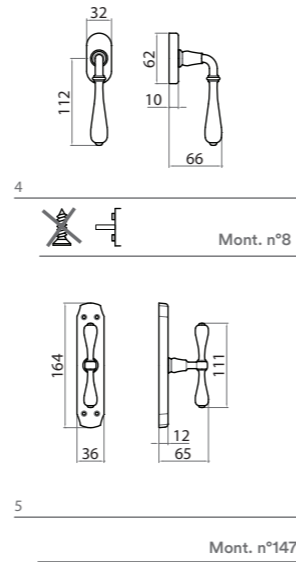

	OBR	OLV	OCL	OLD	OFA	Conf. Pz.
4 MART Martellina Q7 window handle	55196500000	55196500001	55196500007	55196500028	55196500029	2
	39,42	34,52	40,52	34,52	48,52	
5 DK x 40-35 Martellina DK Q7 x 40-35 window handle DK x 40-35mm	55196577000	55196577001	55196577007	55196577028	55196577029	2
	39,95	36,90	40,65	36,90	45,65	
5 DK x 40-35 C/BUSS Martellina DK Q7 x 40-35 con bussole window handle DK x 40-35 mm with pins D.9,5	55196578000	55196578001	55196578007	55196578028	55196578029	2
	39,95	36,90	40,65	36,90	45,65	



Per istruzioni di montaggio scansiona QR code, seleziona il numero di riferimento e segui le istruzioni.  
For assembly instructions scan the QR code, select the relevant assembly number and follow the instructions.

# PIGNA

OTTONE

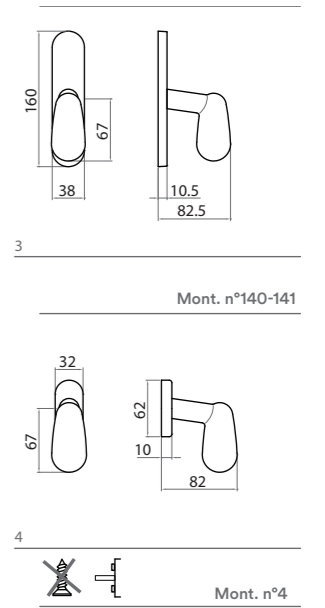

	OLV	OCS	OCL	Conf. Pz.
3 EZ IM Cremonese gioco EZ imp. maniglia Mechanism for window handle spindle 7 mm	55442456001	55442456003	55442456007	2
	88,01	86,01	94,01	
3 EZQ7 IM Cremonese gioco EZ + Q7 imp. maniglia Mechanism for window handle spindle 7 mm	55442457001	55442457003	55442457007	2
	88,60	86,60	94,60	
3 MART IM Martellina Q7 imp. Maniglia lever window handle	55442550001	55442550003	55442550007	2
	88,01	86,01	94,01	
4 DK X 40 Martellina DK Q7 x 40 window handle DK x 40 mm	55442557001	55442557003	55442557007	2
	36,07	34,82	39,82	
4 DK X 40 C/BUSS. Martellina DK Q7 x 40 con bussole D. 9,5 window handle DK x 40mm with pins D.9,5	55442558001	55442558003	55442558007	2
	36,07	34,82	39,82	



Per istruzioni di montaggio scansiona QR code, seleziona il numero di riferimento e segui le istruzioni.  
For assembly instructions scan the QR code, select the relevant assembly number and follow the instructions.

# R5200

OTTONE

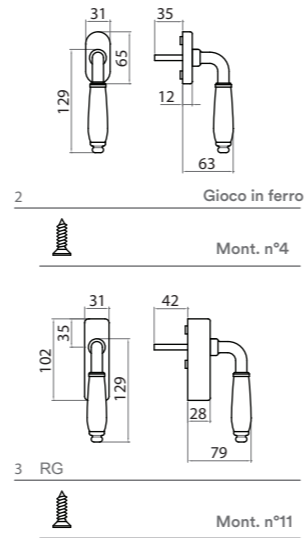

	OCS-PB	OCL-PB	OFA-NO	ONL-NO	Conf. Pz.
2 DK x 35 VM C/BUSS. Martellina DK Q7x35 c/bussole D.9,5 mm viti metriche window handle DK x 35 mm with pins D.9,5 metric screws	R5200000480C390	R5200000480C790	R5200000480UF90	R5200000480UN90	1
	41,37	46,37	51,37	51,37	
3 DK x 42 C/CHIAVE VM C/BUSS. Martellina con chiave DK Q7x42 c/bussole D.9,5 mm viti metriche window handle DK x 42mm with key / pins D.9,5 with screws	R520000A484C390	R520000A484C790	R520000A484UF90	R520000A484UN90	1
	119,78	124,78	129,78	129,78	



Per istruzioni di montaggio scansiona QR code, seleziona il numero di riferimento e segui le istruzioni.  
For assembly instructions scan the QR code, select the relevant assembly number and follow the instructions.

# R716

OTTONE

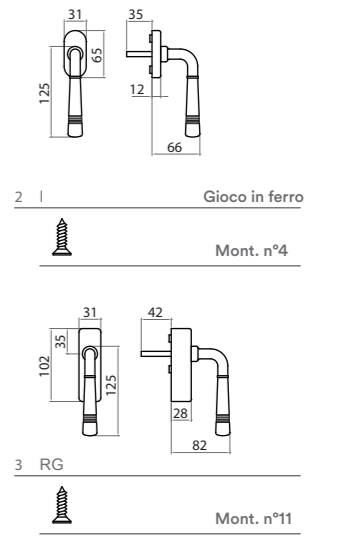

	OLV	OCL	ONS	OLD	OFA	OANT	Conf. Pz.
2 DK x 35 C/BUSS. Martellina DK Q7x35 c/bussole D.9,5 mm viti metriche window handle DK x 35 mm with pins D.9,5 metric screws	R07160004800190	R07160004800790	R07160004802790	R07160004802890	R07160004802990	R07160004804290	1
	26,31	30,06	35,06	22,35	31,10	31,10	
3 DK x 42 C/CHIAVE C/BUSS. Martellina con chiave DK Q7x42 c/bussole D.9,5 mm viti metriche window handle DK x 42mm with key / pins D.9,5 with screws	R071600A4840190	R071600A4840790	R071600A4842790	R071600A4842890	R071600A4842990	R071600A4844290	1
	104,87	108,62	113,62	103,15	111,90	111,90	



Per istruzioni di montaggio scansiona QR code, seleziona il numero di riferimento e segui le istruzioni.  
For assembly instructions scan the QR code, select the relevant assembly number and follow the instructions.

# R771

OTTONE

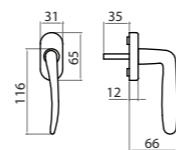

2 [  Gioco in ferro  
Mont. n°4

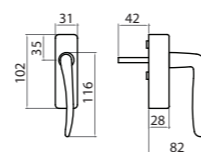

3 RG  Mont. n°11

	OLV	OCS	OCL	ONS	Conf. Pz.
3 DK x 35 C/BUSS. Martellina DK Q7x35 c/bussole D.9,5 mm viti metriche window handle DK x 35 mm with pins D.9,5 metric screws	R07710004800190	R07710004800390	R07710004800790	R07710004802790	1
	28,18	26,93	31,93	36,93	
4 DK x 42 C/CHIAVE C/BUSS. Martellina con chiave DK Q7x42 c/bus D.9,5 mm viti metr window handle DK x 42mm with key / pins D.9,5 with screws	R077100A4840190	R077100A4840390	R077100A4840790	R077100A4842790	1
	106,45	105,20	110,20	115,20	



Per istruzioni di montaggio  
scansiona QR code,  
seleziona il numero di  
riferimento e segui le  
istruzioni.  
For assembly instructions  
scan the QR code, select the  
relevant assembly number  
and follow the instructions.

# R775

OTTONE

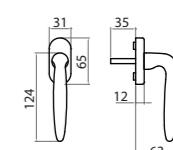

2 I  Gioco in ferro  
Mont. n°4

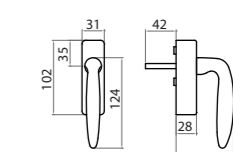

3 RG  Mont. n°11

	ZCL	GCTOL	ZCS	ZNS	Conf. Pz.
2 DK x 35 C/BUSS. Martellina DK Q7x35 c/bussole D.9,5 mm viti metriche window handle DK x 35 mm with pins D.9,5 metric screws	R07750004800790	R07750004801290	R07750004801390	R07750004802790	1
	36,10	32,35	31,10	41,10	
3 DK x 42 C/CHIAVE C/BUSS. Martellina con chiave DK Q7x42 c/bussole D.9,5 mm viti metric window handle DK x 42mm with key / pins D.9,5 with screws	R077500A4840790	R077500A4841290	R077500A4841390	R077500A4842790	1
	114,37	110,62	109,37	119,37	



Per istruzioni di montaggio  
scansiona QR code,  
seleziona il numero di  
riferimento e segui le  
istruzioni.  
For assembly instructions  
scan the QR code, select the  
relevant assembly number  
and follow the instructions.

# R901

OTTONE

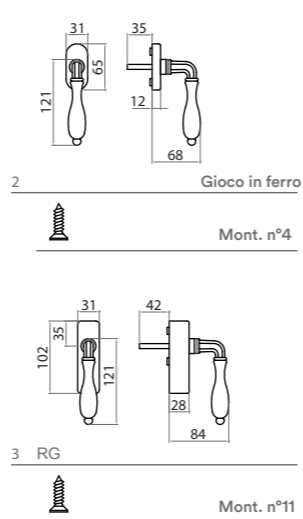

	OLV	OCL	OLD	OFA	OANT	Conf. Pz.
2 DK x 35 VM C/BUSS. Martellina DK Q7x35 c/bussole D.9,5 mm viti metriche window handle DK x 35 mm with pins D.9,5 metric screws	R09010004800190	R09010004800790	R09010004802890	R09010004802990	R09010004804290	1
DK x 42 C/CHIAVE VM C/BUSS.	R090100A4840190	R090100A4840790	R090100A4842890	R090100A4842990	R090100A4844290	1
3 Martellina con chiave DK Q7x42 c/bussole D.9,5 mm viti metriche window handle DK x 42mm with key / pins D.9,5 with screws	121,87	125,62	121,87	130,62	130,62	1



Per istruzioni di montaggio scansiona QR code, seleziona il numero di riferimento e segui le istruzioni.  
For assembly instructions scan the QR code, select the relevant assembly number and follow the instructions.

# R988

OTTONE

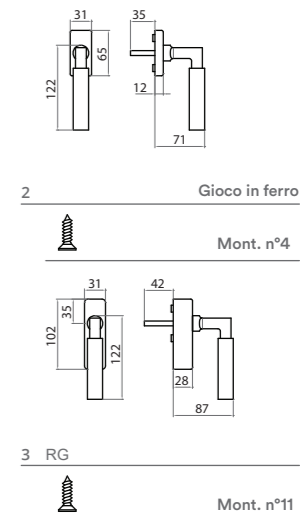

	OCS	OCL	ONS	ONL	OCL-EB	ONL-EB	Conf. Pz.
2 DK X 35 C/BUSS. Martellina DK Q7x35 c/bussole D.9,5 mm viti metriche window handle DK x 35 mm with pins D.9,5 metric screws	R098800C4800390	R098800C4800790	R098800C4802790	R098800C4803090	R098800C480E790	R098800C480EN90	1
3 DK X 42 C/CHIAVE C/BUSS. Martellina con chiave DK Q7x42 c/bussole D.9,5 mm viti metriche window handle DK x 42mm with key / pins D.9,5 with screws	R098800A4840390	R098800A4840790	R098800A4842790	R098800A4843090	R098800A484E790	R098800A484EN90	1



Per istruzioni di montaggio scansiona QR code, seleziona il numero di riferimento e segui le istruzioni.  
For assembly instructions scan the QR code, select the relevant assembly number and follow the instructions.

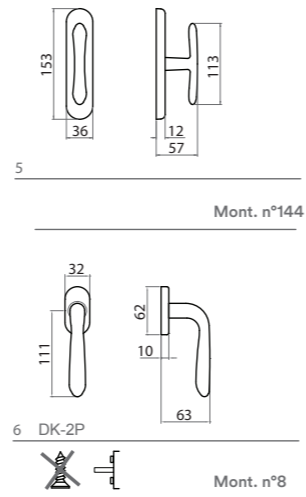

	OLV	OCS	OGV	OCL	Conf. Pz.
3 CREM/MART SG Cremonese-martellina Q7 senza gioco Window handle without mechanism	55796400001	55796400003	55796400004	55796400007	2
3 DK X 40 Martellina DK Q7 x 40 window handle DK x 40 mm	55796557001	55796557003	55796557004	55796557007	2
3 DK X 40 C/BUSS. Martellina DK Q7 x 40 con bussole D. 9,5 window handle DK x 40mm with pins D.9,5	55796558001	55796558003	55796558004	55796558007	2



Per istruzioni di montaggio scansiona QR code, seleziona il numero di riferimento e segui le istruzioni.  
For assembly instructions scan the QR code, select the relevant assembly number and follow the instructions.

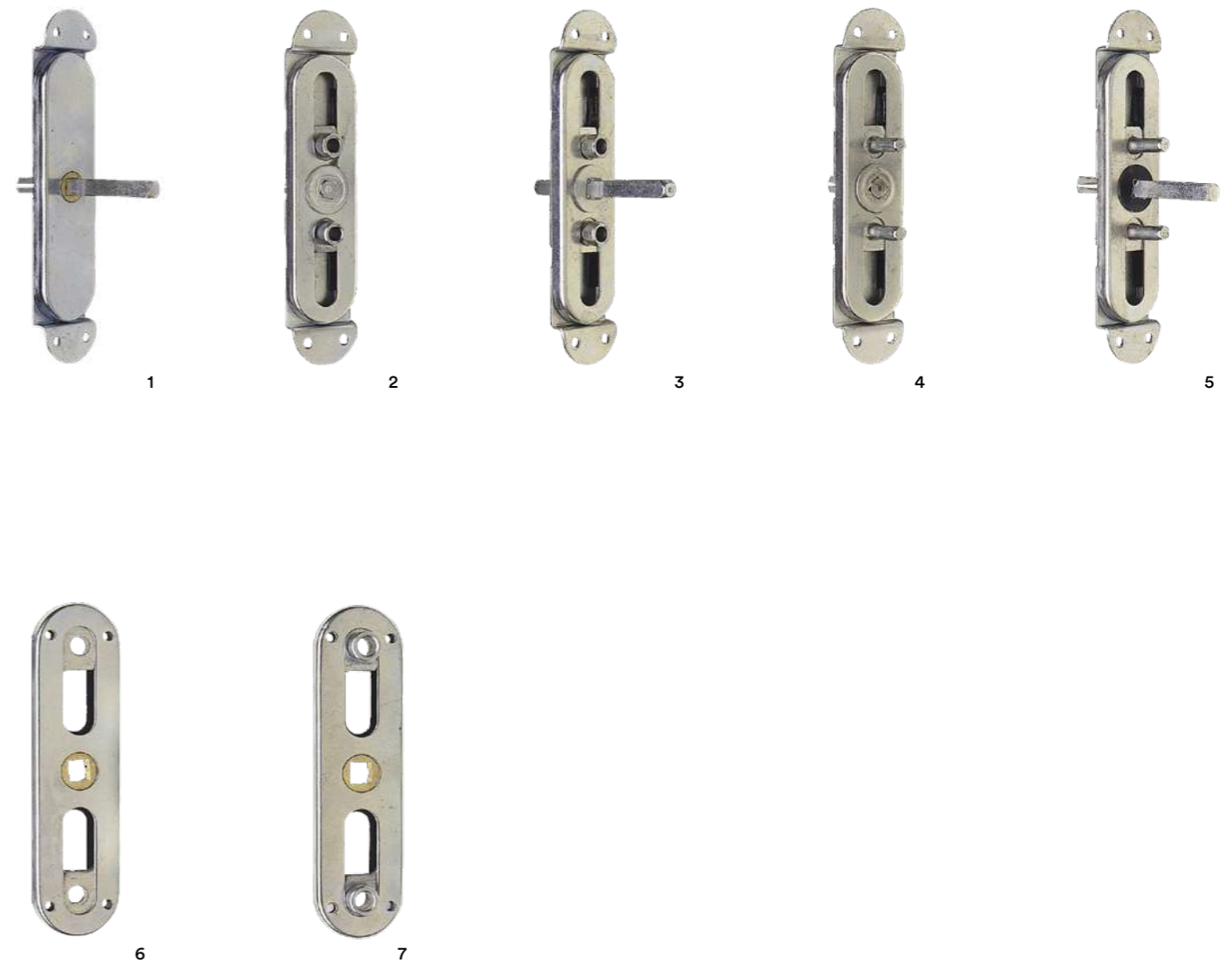

	ZB	Conf. Pz.
1 GIOCO MARTELLINA Q.7 Gioco martellina Q.7 Window mechanism	13350000070	10
2 GIOCO EZ Gioco EZ Window mechanism	13340600070	10
3 GIOCO EZ Q.7 Gioco EZ Q.7 Window mechanism	13340700070	10
4 GIOCO GRAZ PERNI Gioco graz perni Window mechanism	13340200070	10
5 GIOCO GRAZ PERNI Q.7 Gioco graz perni Q.7 Window mechanism	13340900070	10
6 GIOCO GRAZ JOLLY DA APPLICARE Gioco graz jolly da applicare Window mechanism	13341005070	10
7 GIOCO EZ JOLLY DA APPLICARE Gioco EZ jolly da applicare Window mechanism	13341105070	10

## 7900

ALLUMINIO

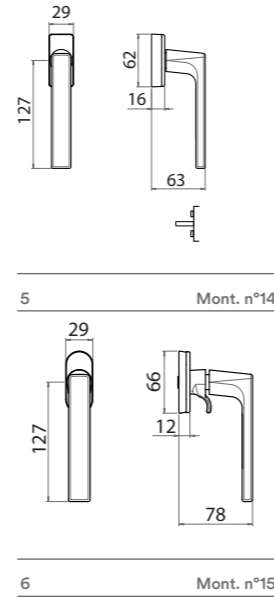

	F1	F3	F4	F9	Conf. Pz.
5 DK40-35 BUS. 9,5 7900 GHTEK DK40-35 BUS. 9,5 window handle DK x 40mm with pins D.9,5	77900583001	77900583003	77900583004	77900583009	20
	9,02	9,39	9,39	9,39	
6 DK X 40 BUS. 9,5 SECURPULL Martellina DK Q7 x 40 BUSS. 9,5 SECURPULL window handle DK x 40 mm with pins D.9,5 SECURPULL	77900575001	77900575003	77900575004	77900575009	20
	10,62	10,99	10,99	10,99	

	RAL9010	GCTOL	ANO	F1-SAT	Conf. Pz.
5 DK40-35 BUS. 9,5 7900 GHTEK DK40-35 BUS. 9,5 window handle DK x 40mm with pins D.9,5	77900583007	77900583012	77900583016	77900583033	20
	8,81	14,23	9,96	15,25	
6 DK X 40 BUS. 9,5 SECURPULL 7900 DK Q7 x 40 BUSS. 9,5 SECURPULL window handle DK x 40 mm with pins D.9,5 SECURPULL	77900575007	77900575012	77900575016	77900575033	20
	10,41	15,09	11,81	13,83	



Per istruzioni di montaggio  
scansiona QR code,  
seleziona il numero di  
riferimento e segui le  
istruzioni.  
For assembly instructions  
scan the QR code, select the  
relevant assembly number  
and follow the instructions.

## ARCHIMEDE

ALLUMINIO

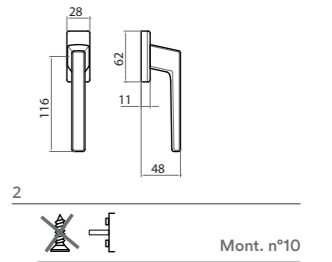

	F1-SAT	Conf. Pz.
2 DK x 40 Martellina DK Q7 x 40 window handle DK x 40 mm	7769655033	2
	12,95	
2 DK X 40 C/BUS Martellina DK Q7 x 40 con bussole D. 9,5 window handle DK x 40mm with pins D.9,5	77696556033	2
	12,95	

	F1	F3	F4	Conf. Pz.
2 DK X 33 C/BUSS D.9,5 ARCHIMEDE DKx33 8SC BUS. 9,5 window handle DK x 33mm with pins D.9,5	7400855830158	7400855830358	7400855830458	100
	6,60	6,97	6,97	
2 DK X 35 C/BUSS D.9,5 ARCHIMEDE DKx35 8SC BUS. 9,5 window handle DK x 35 mm with pins D.9,5	7400855850158	7400855850358	7400855850458	100
	6,60	6,97	6,97	
2 DK X 40 C/BUSS D.9,5 ARCHIMEDE DKx40 8SC BUS. 9,5 window handle DK x 40 mm with pins D.9,5	7408855800158	7400855800358	7400855800458	100
	6,60	6,97	6,97	
2 DK X 45 C/BUSS D.9,5 ARCHIMEDE DKx45 8SC BUS. 9,5 window handle DK x 45 mm with pins D.9,5	7408855840158	7400855840358	7400855840458	100
	6,60	6,97	6,97	



Per istruzioni di montaggio  
scansiona QR code,  
seleziona il numero di  
riferimento e segui le  
istruzioni.  
For assembly instructions  
scan the QR code, select the  
relevant assembly number  
and follow the instructions.



# BRIXIA

ALLUMINIO

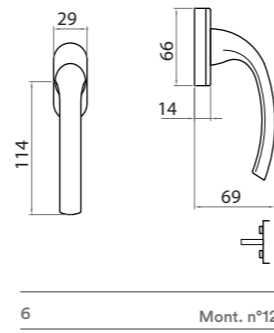

	F1	F3	F4	F9	Conf. Pz.
6 DKx33 8SC BUS. 9,6 BRIXIA DKx33 8SC BUS. 9,5	7743855830158	7743855830358	7743855830458	7743855830958	100
	6,60	6,97	6,97	6,97	
6 DKx35 8SC BUS. 9,6 BRIXIA DKx35 8SC BUS. 9,5	7743855850158	7743855850358	7743855850458	7743855850958	100
	6,60	6,97	6,97	6,97	
6 DKx40 8SC BUS. 9,6 BRIXIA DKx40 8SC BUS. 9,5	7743855800158	7743855800358	7743855800458	7743855800958	100
	6,60	6,97	6,97	6,97	
6 DKx45 8SC BUS. 9,6 BRIXIA DKx45 8SC BUS. 9,5	7743855840158	7743855840358	7743855840458	7743855840958	100
	6,60	6,97	6,97	6,97	
	RAL9010	RAL1013	ANO	RAL9016	Conf. Pz.
6 DKx33 8SC BUS. 9,6 BRIXIA DKx33 8SC BUS. 9,5	7743855830758	7743855831058	7743855831658	7743855838058	100
	6,39	7,54	7,54	6,39	
6 DKx35 8SC BUS. 9,6 BRIXIA DKx35 8SC BUS. 9,5	7743855850758	7743855851058	7743855851658	7743855858058	100
	6,39	7,54	7,54	6,39	
6 DKx40 8SC BUS. 9,6 BRIXIA DKx40 8SC BUS. 9,5	7743855800758	7743855801058	7743855801658	7743855808058	100
	6,39	7,54	7,54	6,39	
6 DKx45 8SC BUS. 9,6 BRIXIA DKx45 8SC BUS. 9,5	7743855840758	7743855841058	7743855841658	7743855848058	100
	6,39	7,54	7,54	6,39	



Per istruzioni di montaggio scansiona QR code, seleziona il numero di riferimento e segui le istruzioni.  
For assembly instructions scan the QR code, select the relevant assembly number and follow the instructions.

# BRIXIA 2

ALLUMINIO

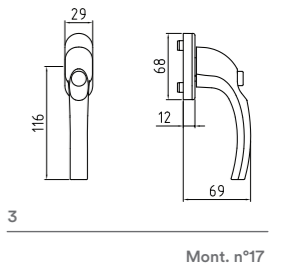
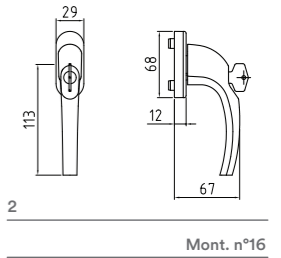
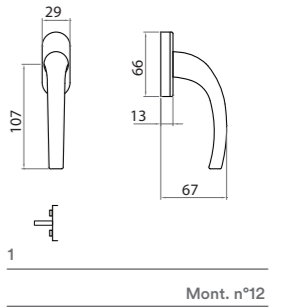

	F1	F3	F4	Conf. Pz.
1 DKx33 8SC BUS. 9,5 BRIXIA/2 DKx33 8SC BUS. 9,5 window handle DK x 33mm with pins D.9,5	7743355830158	7743355830358	7743355830458	100
	4,48	4,85	4,85	
1 DKx35 8SC BUS. 9,5 BRIXIA/2 DKx35 8SC BUS. 9,5 window handle DK x 35mm with pins D.9,5	7743355850158	7743355850358	7743355850458	100
	4,48	4,85	4,85	
1 DKx40 8SC BUS. 9,5 BRIXIA/2 DKx40 8SC BUS. 9,5 window handle DK x 40mm with pins D.9,5	7743355800158	7743355800358	7743355800458	100
	4,48	4,85	4,85	
1 DKx45 8SC BUS. 9,5 BRIXIA/2 DKx45 8SC BUS. 9,5 window handle DK x 45mm with pins D.9,5	7743355840158	7743355840358	7743355840458	100
	4,48	4,85	4,85	
2 DK X 40 C/BUSS D.9,5 BRIXIA/2 con chiave DK Q7 x 40 con bussole D. 9,5 window handle DK x 40mm with pins D.9,5	77433563501	77433563503	77433563504	5
	23,12	24,48	24,48	
3 DK X 40 C/BUSS D.9,5 BRIXIA/2 con pulsante DK Q7 x 40 con bussole D. 9,5 window handle DK x 40mm with pins D.9,5	77433562501	77433562503	77433562504	5
	19,30	27,70	21,32	

	RAL9010	RAL1013	ANO	RAL9016	Conf. Pz.
1 DKx33 8SC BUS. 9,5 BRIXIA/2 DKx33 8SC BUS. 9,5 window handle DK x 33mm with pins D.9,5	7743355830758	7743355831058	7743355831658	7743355838058	100
	4,27	5,42	5,42	4,27	
1 DKx35 8SC BUS. 9,5 BRIXIA/2 DKx35 8SC BUS. 9,5 window handle DK x 35mm with pins D.9,5	7743355850758	7743355851058	7743355851658	7743355858058	100
	4,27	5,42	5,42	4,27	
1 DKx40 8SC BUS. 9,5 BRIXIA/2 DKx40 8SC BUS. 9,5 window handle DK x 40mm with pins D.9,5	7743355800758	7743355801058	7743355801658	7743355808058	100
	4,27	5,42	5,42	4,27	
1 DKx45 8SC BUS. 9,5 BRIXIA/2 DKx45 8SC BUS. 9,5 window handle DK x 45mm with pins D.9,5	7743355840758	7743355841058	7743355841658	7743355848058	100
	4,27	5,42	5,42	4,27	
2 DK X 40 C/BUSS D.9,5 BRIXIA/2 con chiave DK Q7 x 40 con bussole D. 9,5 window handle DK x 40mm with pins D.9,5	77433563607	77433563510	77433563516	77433563580	5
	21,11	27,44	27,44	21,11	
3 DK X 40 C/BUSS D.9,5 BRIXIA/2 con pulsante DK Q7 x 40 con bussole D. 9,5 window handle DK x 40mm with pins D.9,5	77433562507	77433562510	77433562516	77433562580	5
	18,44			18,44	

# CARLO

ALLUMINIO

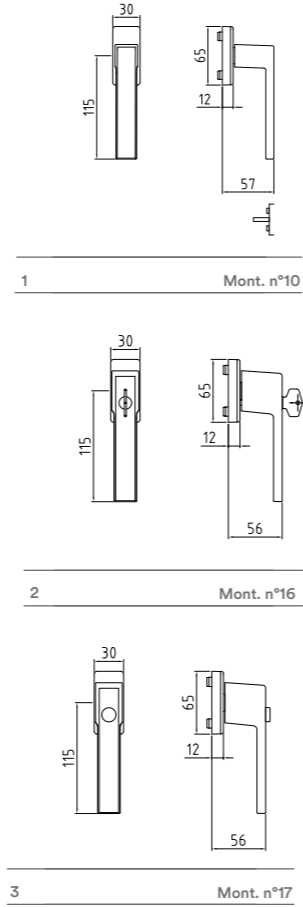

	F1	F3	F4	F9	Conf. Pz.
1 DK X 35 C/BUSS D.9,5 CARLO DKX35 8SC RET BUS.9,5 window handle DK x 35mm with pins D.9,5	7750255650108	7750255650308	7750255650408	7750255650908	100
	6,61	7,89	7,89	7,89	
1 DK X 40 C/BUSS D.9,5 CARLO DK Q7 x 40 con bussole D. 9,5 window handle DK x 40mm with pins D.9,5	7750255600108	7750255600308	7750255600408	7750255600908	20
	6,61	7,89	7,89	10,25	
1 DK X 45 C/BUSS D.9,5 CARLO DKX45 8SC RET BUS.9,5 window handle DK x 45mm with pins D.9,5	7750255640108	7750255640308	7750255640408	7750255640908	100
	6,61	7,89	7,89	7,89	
1 DK X 50 C/BUSS D.9,5 CARLO DKX50 8SC RET BUS.9,5 window handle DK x 50mm with pins D.9,5	7750255660108	7750255660308	7750255660408	7750255660908	100
	6,61	7,89	7,89	7,89	
2 DK X 45 C/BUSS D.9,5 CARLO con chiave DK Q7 x 45 con bussole D. 9,5 window handle DK x 45mm with pins D.9,5	77502563301	77502563303	77502563304	77502563309	5
	27,52	29,61	29,61	38,44	
2 DK X 40 C/BUSS D.9,5 CARLO con chiave DK Q7 x 40 con bussole D. 9,5 window handle DK x 40mm with pins D.9,5	77502563501	77502563503	77502563504		5
	27,52	29,61	29,61		
3 DK X 40 C/BUSS D.9,5 CARLO con pulsante DK Q7 x 40 con bussole D. 9,5 window handle DK x 40mm with pins D.9,5	77502562501	77502562503	77502562504	77502562509	5
	23,41		25,14	32,70	
	RAL9010	RAL1013	ANO	RAL9016	Conf. Pz.
1 DK X 35 C/BUSS D.9,5 CARLO DKX35 8SC RET BUS.9,5 window handle DK x 35mm with pins D.9,5	7750255650708	7750255651008	7750255651608	7750255658008	100
	5,59	8,50	8,50	5,59	
1 DK X 40 C/BUSS D.9,5 CARLO DK Q7 x 40 con bussole D. 9,5 window handle DK x 40mm with pins D.9,5	7750255600708	7750255601008	7750255601608	7750255608008	20
	5,59	8,50	8,50	5,59	
1 DK X 45 C/BUSS D.9,5 CARLO DKX45 8SC RET BUS.9,5 window handle DK x 45mm with pins D.9,5	7750255640708	7750255641008	7750255641608	7750255648008	100
	5,59	8,50	8,50	5,59	
1 DK X 50 C/BUSS D.9,5 CARLO DKX50 8SC RET BUS.9,5 window handle DK x 50mm with pins D.9,5	7750255660708	7750255661008	7750255661608	7750255668008	100
	5,59	8,50	8,50	5,59	
2 DK X 45 C/BUSS D.9,5 CARLO con chiave DK Q7 x 45 con bussole D. 9,5 window handle DK x 45mm with pins D.9,5	77502563307	77502563310	77502563316	77502563380	5
	26,20	35,65	35,65	26,20	
2 DK X 40 C/BUSS D.9,5 CARLO con chiave DK Q7 x 40 con bussole D. 9,5 window handle DK x 40mm with pins D.9,5	77502563507	77502563510	77502563516	77502563580	5
	26,20	35,65	35,65	26,20	
3 DK X 40 C/BUSS D.9,5 CARLO con pulsante DK Q7 x 40 con bussole D. 9,5 window handle DK x 40mm with pins D.9,5	77502562507	77502562510	77502562516	77502562580	5
			39,41	28,19	

# DELTA

ALLUMINIO

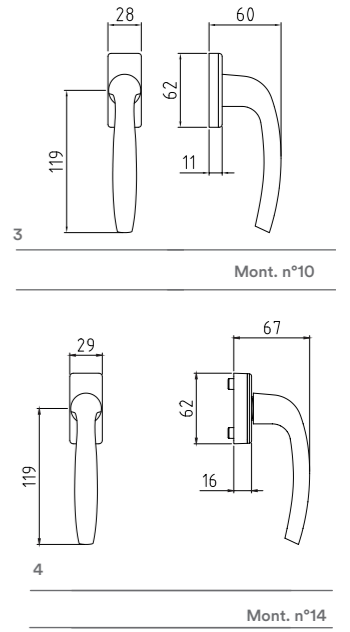

	F1	F3	F4	RAL9010	F9	ANO	Conf. Pz.
3 DK x 45 C/BUSS D.9,5 DELTA DK X 45 C/BUSS D.9,5 window handle DK x 45 mm with pins D.9,5	7721055600158	7721055600358	7721055600458	7721055600758	7721055600958	7721055601658	100
	6,60	6,97	6,97	6,39	7,58	7,54	
4 DK X 45 BUS. 9,5 GHTECH DELTA DK X 45 BUS. 9,5 GHTECH window handle DK x 45 mm with pins D.9,5 GHTECH	77210583001	77210583003	77210583004	77210583007	77210583009	77210583016	10
	9,32	9,32	9,32	9,02	10,70	10,65	



Per istruzioni di montaggio scansiona QR code, seleziona il numero di riferimento e segui le istruzioni.  
For assembly instructions scan the QR code, select the relevant assembly number and follow the instructions.

# FLY 24

ALLUMINIO

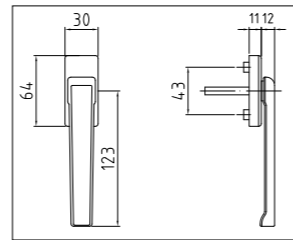

1

Mont. n°12

- 1 DKx40 FLY 24  
Martellina FLY 24 DK Q7 x 40 con bussole D. 9,5  
window handle DK

	F1	F4	Conf. Pz.
	7747955600108	7747955600408	
	8,50	9,30	



Per istruzioni di montaggio  
scansiona QR code,  
seleziona il numero di  
riferimento e segui le  
istruzioni.  
For assembly instructions  
scan the QR code, select the  
relevant assembly number  
and follow the instructions.

# FLY SCREEN

ALLUMINIO

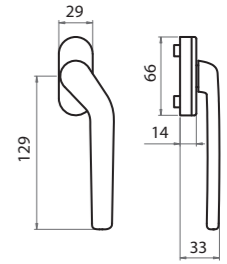

1

Mont. n°12

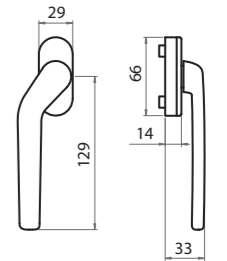

2

Mont. n°12

- 1 DK X 40 FLY SCREEN  
Martellina FLY SCREEN DX DK Q7 x 40 con bussole D. 9,5  
window handle DX DK x 40mm FLY SCREEN
- 2 DK X 40 FLY SCREEN  
Martellina FLY SCREEN SX DK Q7 x 40 con bussole D. 9,5  
window handle SX DK x 40mm FLY SCREEN

	F1	F4	Conf. Pz.
	77478558001	77478558004	20
	7,11	7,48	
	77478559001	77478559004	20
	7,11	7,48	



Per istruzioni di montaggio  
scansiona QR code,  
seleziona il numero di  
riferimento e segui le  
istruzioni.  
For assembly instructions  
scan the QR code, select the  
relevant assembly number  
and follow the instructions.

# GABRY

ALLUMINIO

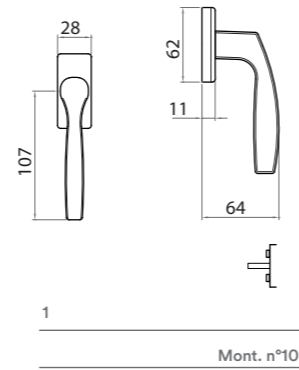

	F1	F3	F4	Conf. Pz.
1 DK X 33 C/BUSS D.9,5 GABRY TN DKX33 RETT BUS window handle DK x 33mm with pins D.9,5	7740055600158	7740055600358	7740055600458	100
	6,60	6,97	6,97	
1 DK X 35 C/BUSS D.9,5 GABRY TN DKX35 RETT BUS window handle DK x 35mm with pins D.9,5	7740055650158	7740055650358	7740055650458	100
	6,60	6,97	6,97	
1 DK X 40 C/BUSS D.9,5 GABRY TN DKX40 RETT BUS window handle DK x 40mm with pins D.9,5	7740055630158	7740055630358	7740055630458	100
	6,60	6,97	6,97	
1 DK X 45 C/BUSS D.9,5 GABRY TN DKX45 RETT BUS window handle DK x 45mm with pins D.9,5	7740055640158	7740055640358	7740055640458	100
	6,60	6,97	6,97	



Per istruzioni di montaggio scansiona QR code, seleziona il numero di riferimento e segui le istruzioni.  
For assembly instructions scan the QR code, select the relevant assembly number and follow the instructions.

# 2005 ITACA

ALLUMINIO

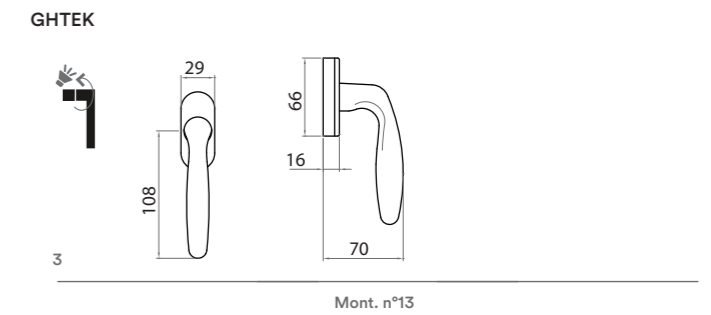
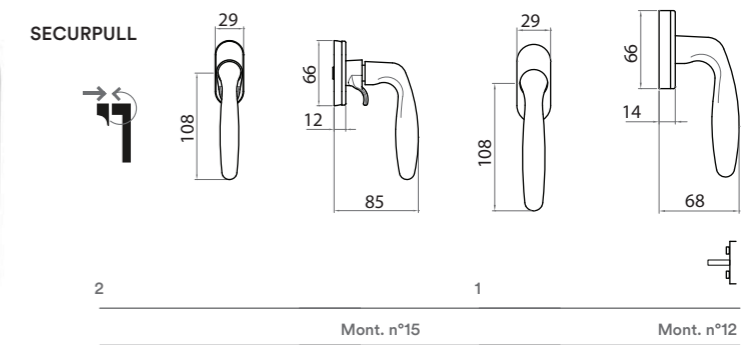

	F1	F3	F4	F9	Conf. Pz.
1 DK X 33 C/BUSS D.9,5 ITACA DKX33 BUS window handle DK x 33mm with pins D.9,5	7200555830158	7200555830358	7200555830458	7200555830958	100
	6,60	6,97	6,97	6,97	
1 DK X 35 C/BUSS D.9,5 ITACA DKX35 BUS window handle DK x 35mm with pins D.9,5	7200555850158	7200555850358	7200555850458	7200555850958	100
	6,60	6,97	6,97	6,97	
1 DK X 40 C/BUSS D.9,5 ITACA DKX40 BUS window handle DK x 40mm with pins D.9,5	7200555800158	7200555800358	7200555800458	7200555800958	100
	6,60	6,97	6,97	6,97	
1 DK X 45 C/BUSS D.9,5 ITACA DKX45 BUS window handle DK x 45mm with pins D.9,5	7200555840158	7200555840358	7200555840458	7200555840958	100
	6,60	6,97	6,97	6,97	
2 DK X 40 SECURPULL ITACA SECURPULL DK40 window handle DK x 40mm SECURPULL	72005575001	72005575003	72005575004	72005575009	20
	10,62	10,99	10,99	10,99	
3 DK X 40-35 GHTECH ITACA GHTEK DK40-35 window handle DK x 40mm GHTECH	72005574001	72005574003	72005574004	72005574009	20
	9,32	9,32	9,32	10,70	



Per istruzioni di montaggio scansiona QR code, seleziona il numero di riferimento e segui le istruzioni.  
For assembly instructions scan the QR code, select the relevant assembly number and follow the instructions.

# KEY

ALLUMINIO

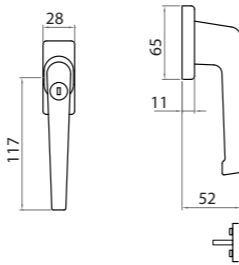

Mont. n°16

	F1	F3	F4	Conf. Pz.
3 DK X 33 C/BUSS D.9,5 KEY DKx33 RETT BUS window handle DK x 33mm with pins D.9,5	77062556001	77062556003	77062556004	10
	19,04	19,41	19,41	



Per istruzioni di montaggio  
scansiona QR code,  
seleziona il numero di  
riferimento e segui le  
istruzioni.  
For assembly instructions  
scan the QR code, select the  
relevant assembly number  
and follow the instructions.

# ROOF

ALLUMINIO

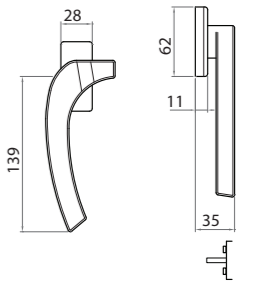

Mont. n°10

	ACH	Conf. Pz.
3 DK S/FERRO ROOF DK S/F window handle DK	77040554521	20
	8,48	



Per istruzioni di montaggio  
scansiona QR code,  
seleziona il numero di  
riferimento e segui le  
istruzioni.  
For assembly instructions  
scan the QR code, select the  
relevant assembly number  
and follow the instructions.

# SEVEN

ALLUMINIO

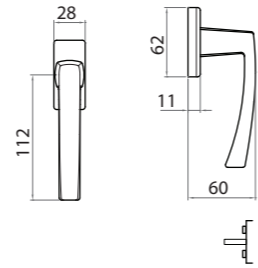

Mont. n°10

	F1	F3	F4	F9	Conf. Pz.
DK X 33 C/BUSS D.9,5	7747055630158	7747055630358	7747055630458	7747055630958	
SEVEN DKX33 8SC RETT C/BUSS D.9,5 window handle DK x 33mm with pins D.9,5	6,60	6,97	6,97	6,97	100
DK X 35 C/BUSS D.9,5	7747055650158	7747055650358	7747055650458	7747055650958	
SEVEN DKX35 8SC RETT C/BUSS D.9,5 window handle DK x 35mm with pins D.9,5	6,60	6,97	6,97	6,97	100
DK X 40 C/BUSS D.9,5	7747055600158	7747055600358	7747055600458	7747055600958	
SEVEN DKX40 8SC RETT C/BUSS D.9,5 window handle DK x 40mm with pins D.9,5	6,60	6,97	6,97	6,97	100
DK X 45 C/BUSS D.9,5	7747055640158	7747055640358	7747055640458	7747055640958	
SEVEN DKX45 8SC RETT C/BUSS D.9,5 window handle DK x 45mm with pins D.9,5	6,60	6,97	6,97	6,97	100



Per istruzioni di montaggio scansiona QR code, seleziona il numero di riferimento e segui le istruzioni.  
For assembly instructions scan the QR code, select the relevant assembly number and follow the instructions.

# SEVEN Q

ALLUMINIO

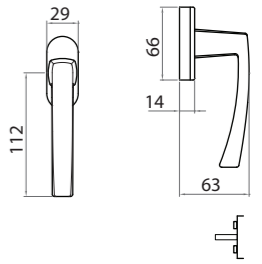

Mont. n°12

	F1	F3	F4	F9	Conf. Pz.
DK X 33 C/BUSS D.9,5	7747055630158	7747055630358	7747055630458	7747055630958	
SEVEN DKX33 8SC RETT C/BUSS D.9,5 window handle DK x 33mm with pins D.9,5	6,60	6,97	6,97	6,97	100
DK X 35 C/BUSS D.9,5	7747055650158	7747055650358	7747055650458	7747055650958	
SEVEN DKX35 8SC RETT C/BUSS D.9,5 window handle DK x 35mm with pins D.9,5	6,60	6,97	6,97	6,97	100
DK X 40 C/BUSS D.9,5	7747055600158	7747055600358	7747055600458	7747055600958	
SEVEN DKX40 8SC RETT C/BUSS D.9,5 window handle DK x 40mm with pins D.9,5	6,60	6,97	6,97	6,97	100
DK X 45 C/BUSS D.9,5	7747055640158	7747055640358	7747055640458	7747055640958	
SEVEN DKX45 8SC RETT C/BUSS D.9,5 window handle DK x 45mm with pins D.9,5	6,60	6,97	6,97	6,97	100



Per istruzioni di montaggio scansiona QR code, seleziona il numero di riferimento e segui le istruzioni.  
For assembly instructions scan the QR code, select the relevant assembly number and follow the instructions.

# SHARK

ALLUMINIO

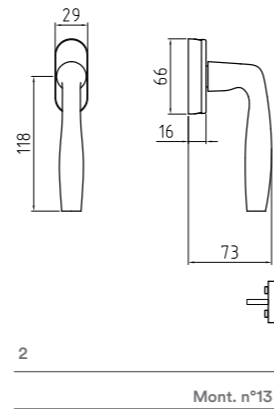
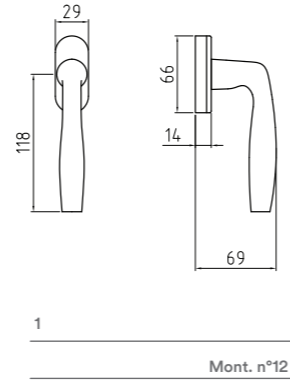

	F1	F3	F4	F9	Conf. Pz.
1 DKx33 8SC BUS. 9,5 SHARK DKx33 8SC BUS. 9,5 window handle DK x 33mm with pins D.9,5	7708055830158	7708055830358	7708055830458	7708055830958	100
	6,60	6,97	6,97	6,97	
1 DKx35 8SC BUS. 9,5 SHARK DKx35 8SC BUS. 9,5 window handle DK x 35mm with pins D.9,5	7708055850158	7708055850358	7708055850458	7708055850958	100
	6,60	6,97	6,97	6,97	
1 DKx40 8SC BUS. 9,5 SHARK DKx40 8SC BUS. 9,5 window handle DK x 40mm with pins D.9,5	7708055800158	7708055800358	7708055800458	7708055800958	100
	6,60	6,97	6,97	6,97	
1 DKx45 8SC BUS. 9,5 SHARK DKx45 8SC BUS. 9,5 window handle DK x 45mm with pins D.9,5	7708055840158	7708055840358	7708055840458	7708055840958	100
	6,60	6,97	6,97	6,97	
2 DK X 40-35 GHTECH SHARK GHTEK DK40-35 window handle DK x 40mm GHTECH	77080574001	77080574003	77080574004	77080574009	20
	9,32	9,32	9,32	10,70	
2 DK X 40-35 BUS. 9,5 GHTECH SHARK GHTEK DK40-35 BUS. 9,5 window handle DK x 40 mm with pins D.9,5 GHTECH	77080584001	77080584003	77080584004	77080584009	20
	9,02	9,39	9,39	9,39	



Per istruzioni di montaggio scansiona QR code, seleziona il numero di riferimento e segui le istruzioni.  
For assembly instructions scan the QR code, select the relevant assembly number and follow the instructions.

# UNIVERSAL

ALLUMINIO

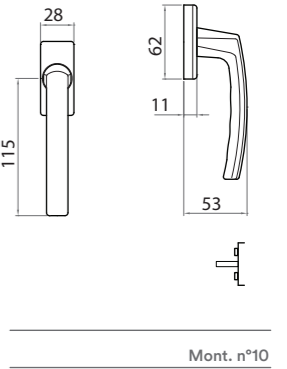

	F1	F3	F4	F9	Conf. Pz.
3 DKx33 8SC BUS. 9,5 UNIVERSAL DKx33 8SC BUS. 9,5 window handle DK x 33mm with pins D.9,5	7748655830158	7748655830358	7748655830458	7748655830958	100
	6,60	6,97	6,97	6,97	
3 DKx35 8SC BUS. 9,5 UNIVERSAL DKx35 8SC BUS. 9,5 window handle DK x 35mm with pins D.9,5	7748655850158	7748655850358	7748655850458	7748655850958	100
	6,60	6,97	6,97	6,97	
3 DKx40 8SC BUS. 9,5 UNIVERSAL DKx40 8SC BUS. 9,5 window handle DK x 40mm with pins D.9,5	7748655800158	7748655800358	7748655800458	7748655800958	100
	6,60	6,97	6,97	6,97	
3 DKx45 8SC BUS. 9,5 UNIVERSAL DKx45 8SC BUS. 9,5 window handle DK x 45mm with pins D.9,5	7748655840158	7748655840358	7748655840458	7748655840958	100
	6,60	6,97	6,97	6,97	



Per istruzioni di montaggio scansiona QR code, seleziona il numero di riferimento e segui le istruzioni.  
For assembly instructions scan the QR code, select the relevant assembly number and follow the instructions.

# 4038

ALLUMINIO

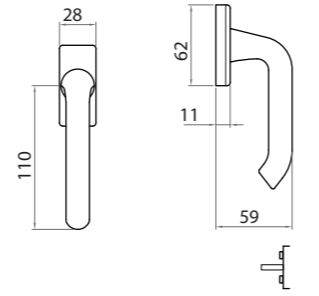

Mont. n°10

	F1	F3	F4	Conf. Pz.
DKx33 8SC BUS. 9,5	7403855830158	7403855830358	7403855830458	
4038 DKx33 8SC BUS. 9,5	6,60	6,97	6,97	100
window handle DK x 33mm with pins D.9,5				
DKx35 8SC BUS. 9,5	7403855850158	7403855850358	7403855850458	
4038 DKx35 8SC BUS. 9,5	6,60	6,97	6,97	100
window handle DK x 35mm with pins D.9,5				
DKx40 8SC BUS. 9,5	7403855800158	7403855800358	7403855800458	
4038 DKx40 8SC BUS. 9,5	6,60	6,97	6,97	100
window handle DK x 40mm with pins D.9,5				
DKx45 8SC BUS. 9,5	7403855840158	7403855840358	7403855840458	
4038 DKx45 8SC BUS. 9,5	6,60	6,97	6,97	100
window handle DK x 45mm with pins D.9,5				



Per istruzioni di montaggio scansiona QR code, seleziona il numero di riferimento e segui le istruzioni.  
For assembly instructions scan the QR code, select the relevant assembly number and follow the instructions.

# UNIVERSALE

ALLUMINIO

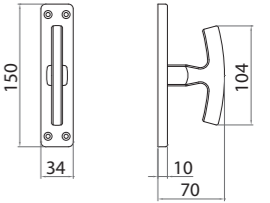

Mont. n°145

	F1	F3	F4	Conf. Pz.
CREM/MART SG	77442400001	77442400003	77442400004	
CREM-MART SG UNIV Alox	9,08	9,08	9,08	10
Window handle without mechanism				
MART	77442500001	77442500003	77442500004	
MART UNIV ALOX	7,30	9,37	7,30	10
window handle				



	ZB	Conf. Pz.
1 GIOCO EZ	13340605070	
GIOCO EZ (062)	3,20	10
Window mechanism		
2 GIOCO EZQ7	13340705070	
GIOCO EZ+Q7	4,90	10
Window mechanism		
3 GIOCO GRAZ	13340305070	
GIOCO GRAZ FORI	2,64	10
Window mechanism		
4 GIOCO GRAZ PERNI	13340205070	
GIOCO GRAZ PERNI	4,75	10
Window mechanism		
5 GIOCO GRAZ Q7	13340315070	
GIOCO GRAZ FORI+Q7	4,07	10
Window mechanism		



Per istruzioni di montaggio scansiona QR code, seleziona il numero di riferimento e segui le istruzioni.  
For assembly instructions scan the QR code, select the relevant assembly number and follow the instructions.



## 2010

ALLUMINIO

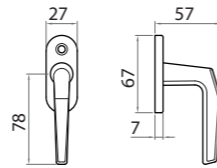

	F1	F3	F4	F9	Conf. Pz.
MART Q7 IM ROV	72010521001	72010521003	72010521004	72010521009	20
2010 MART Q7 ROV *	5,65	6,02	6,02	6,02	
lever window handle on oval rose					

## 6008

ALLUMINIO

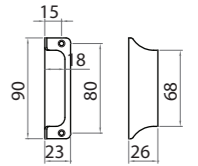

	F1	F3	F4	Conf. Pz.
MANIGLIETTA	76008612001	76008612003	76008612004	20
6008 MANIGLIETTA	5,21	5,21	5,21	
Small handle				

## 3013

ALLUMINIO

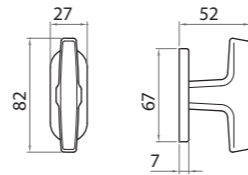

	F1	F3	F4	F9	Conf. Pz.
MART Q7 ROV	73013521001	73013521003	73013521004	73013521009	20
3013 MART Q7 ROV *	5,65	6,02	6,02	6,02	
window handle					

## 6010

ALLUMINIO

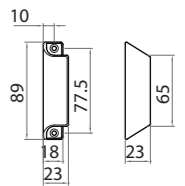

	F1	F3	F4	Conf. Pz.
MANIGLIETTA	76010612001	76010612003	76010612004	20
6010 MANIGLIETTA	6,10	6,10	6,10	
Small handle				

# 7900 BALCONY

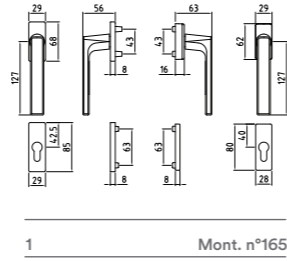

	F1	F3	F4	F9	Conf. Pz.
1 BALCONY DOOR G.ra ros bocc yale per porta balcone Q7 - viti pass Lever handle 7mm on rect rose key hole esc metrich-thread screw	77900217301	77900217303	77900217304	77900217309	
	46,38		47,74	54,90	
	RAL9010	GCTOL	ANO	F1-SAT	Conf. Pz.
1 BALCONY DOOR G.ra ros bocc yale per porta balcone Q7 - viti pass Lever handle 7mm on rect rose key hole esc metrich-thread screw	77900217307	77900217312	77900217316	77900217333	
		73,70	54,90	56,77	

# BRIXIA BALCONY

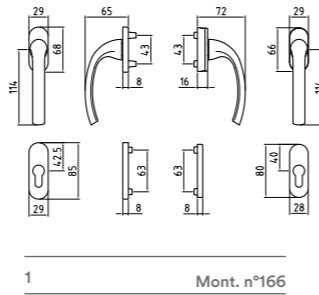

	F1	F3	F4	F9	Conf. Pz.
1 BALCONY DOOR G.ra ros bocc yale per porta balcone Q7 - viti pass Lever handle 7mm on rect rose key hole esc metrich-thread screw	77438227301	77438227303	77438227304	77438227309	
	43,65		45,01	50,20	
	RAL9010	RAL1013	ANO	RAL9016	Conf. Pz.
1 BALCONY DOOR G.ra ros bocc yale per porta balcone Q7 - viti pass Lever handle 7mm on rect rose key hole esc metrich-thread screw	77438227307	77438227310	77438227316	77438227380	
			50,20	50,20	



Per istruzioni di montaggio scansiona QR code, seleziona il numero di riferimento e segui le istruzioni.  
For assembly instructions scan the QR code, select the relevant assembly number and follow the instructions.

# CARLO BALCONY

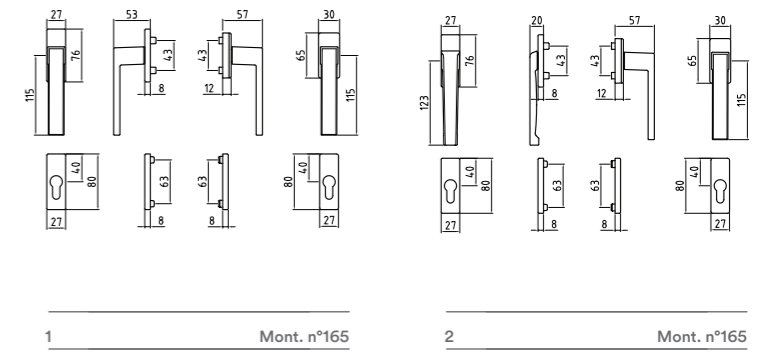

	F1	F4	F9	F3	Conf. Pz.
1 BALCONY DOOR G.ra ros bocc yale per porta balcone Q7 - viti pass Lever handle 7mm on rect rose key hole esc metrich-thread screw	77502217301	77502217304	77502217309		
	60,14	62,99	62,99		
2 BALCONY DOOR G.ra ros bocc yale per porta balcone Q7 - est rib viti pass Lever handle 7mm on rect rose key hole esc metrich-thread screw	77502217501	77502217504	77502217509		
	62,99	65,84	65,84		
	RAL9010	RAL1013	ANO	RAL9016	Conf. Pz.
1 BALCONY DOOR G.ra ros bocc yale per porta balcone Q7 - viti pass Lever handle 7mm on rect rose key hole esc metrich-thread screw	77502217307	77502217310	77502217316	77502217380	
			77,73	57,91	
2 BALCONY DOOR G.ra ros bocc yale per porta balcone Q7 - est rib viti pass Lever handle 7mm on rect rose key hole esc metrich-thread screw	77502217507	77502217510	77502217516	77502217580	
			81,29	60,75	

# ITACA BALCONY

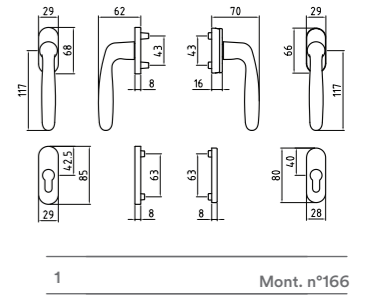

	F1	F4	F9	ANO	RAL9016	Conf. Pz.
1 BALCONY DOOR G.ra ros bocc yale per porta balcone Q7 - viti pass Lever handle 7mm on rect rose key hole esc metrich-thread screw	72005227301	72005227304	72005227309	72005227316	72005227380	
	46,38	47,74	54,90	54,90	54,90	



Per istruzioni di montaggio scansiona QR code, seleziona il numero di riferimento e segui le istruzioni.  
For assembly instructions scan the QR code, select the relevant assembly number and follow the instructions.

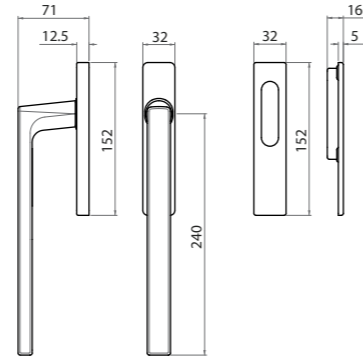

	MERCURY	URANUS	JUPITER	SPACE	Conf. Pz.
SCATTO MAN PC CONCH. Maniglione a scatto placca chiusa con conchiglia Pull handle for sliding door - closed plate	77900601033 62,00 ⚡	77900601034 62,00 ⚡	77900601041 62,00 ⚡	77900601076 62,00 ⚡	1

⚡ Servizio G48: Articolo a magazzino e disponibile entro 48 dall'elaborazione dell'ordine. In base a disponibilita' e condizioni di vendita.  
G48 service: Item in stock and available within 48 hours of order processing. Based on availability and sales conditions.

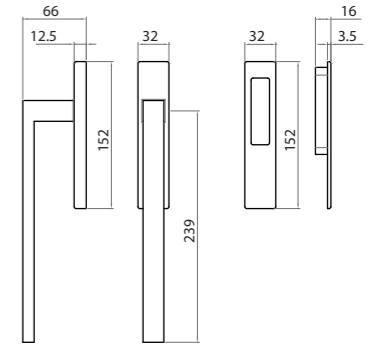

	ZCL	ZCS	ZNO	RAL9010	Conf. Pz.
SCATTO MAN PC CONCH. Maniglione a scatto placca chiusa con conchiglia Pull handle for sliding door - closed plate	66460601007 91,36	66460601013 91,36 ⚡	66460601016 86,06 ⚡	66460601063 86,06 ⚡	1
SCATTO MAN PC PY Maniglione a scatto placca yale Pull handle for sliding door w/cyl. Hole	66460601507 73,51	66460601513 73,51	66460601516 60,98	66460601563 60,98	1
SCATTO MANCP Q 10 PC Coppia maniglioni a scatto Q10 placca chiusa Pair pull handle with 10mm spindle + blind plate	66460620007 143,00	66460620013 143,00	66460620016 119,49	66460620063 119,49	1
SCATTO MANCP Q 10 PY Coppia maniglioni a scatto Q10 placca yale Pair pull handle with 10mm spindle + cyl. plate	66460620507 143,00	66460620513 143,00	66460620516 117,75	66460620563 117,75	1
CONCH MAN SCATTO Conchiglia per maniglione a scatto handle for sliding door	66460680907 14,14	66460680913 14,14	66460680916 13,32	66460680963 13,32	1

⚡ Servizio G48: Articolo a magazzino e disponibile entro 48 dall'elaborazione dell'ordine. In base a disponibilita' e condizioni di vendita.  
G48 service: Item in stock and available within 48 hours of order processing. Based on availability and sales conditions.

# SHARK

OTTONE

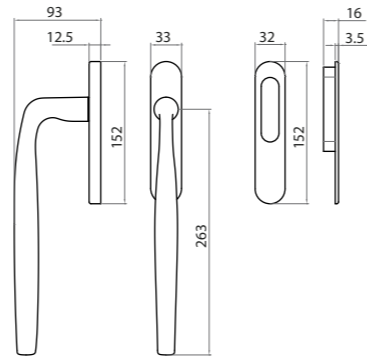

	OLV	OCS	OCL	Conf. Pz.
SCATTO MAN PC CONCH. Maniglione a scatto placca chiusa con conchiglia Pull handle for sliding door - closed plate	55480601001	55480601003	55480601007	1
	146,12	153,12	153,12	
SCATTO MAN PC PY Maniglione a scatto placca yale Pull handle for sliding door w/cyl. Hole	55480601501	55480601503	55480601507	1
	131,99	137,94	137,94	
SCATTO MANCP Q 10 PC Coppia maniglioni a scatto Q10 placca chiusa Pair pull handle with 10mm spindle + blind plate	55480620001	55480620003	55480620007	1
	249,98	262,93	262,93	
SCATTO MANCP Q 10 PY Coppia maniglioni a scatto Q10 placca yale Pair pull handle with 10mm spindle + cyl. plate	55480620501	55480620503	55480620507	1
	249,98	262,93	262,93	

# MILENA

OTTONE

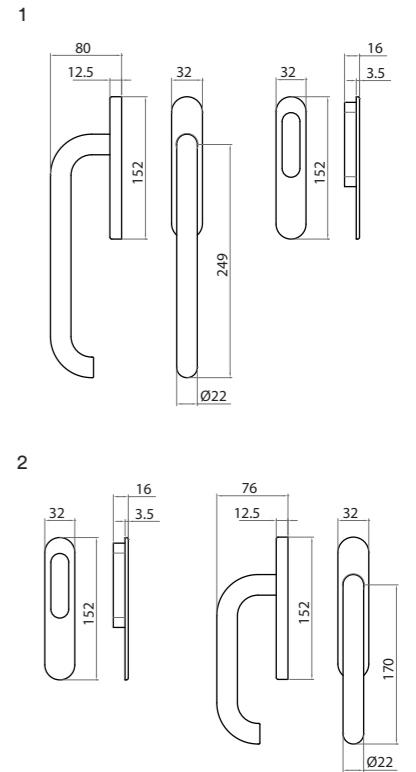

	OLV	OCS	OGV	OCL	OS	Conf. Pz.
1 SCATTO MAN PC CONCH. Maniglione a scatto placca chiusa con conchiglia Pull handle for sliding door - closed plate	55980601001	55980601003	55980601004	55980601007	55980601008	1
	135,26	137,19	135,26	137,19	135,26	
1 SCATTO MAN PC PY Maniglione a scatto placca yale Pull handle for sliding door w/cyl. Hole	55980601501	55980601503	55980601504	55980601507	55980601508	1
	123,21	125,44	123,21	125,44	123,21	
1 SCATTO MANCP Q 10 PC Coppia maniglioni a scatto Q10 placca chiusa Pair pull handle with 10mm spindle + blind plate	55980620001	55980620003	55980620004	55980620007	55980620008	1
	242,54	246,86	242,54	246,86	242,54	
1 SCATTO MANCP Q 10 PY Coppia maniglioni a scatto Q10 placca yale Pair pull handle with 10mm spindle + cyl. plate	55980620501	55980620503	55980620504	55980620507	55980620508	1
	242,54	246,86	242,54	246,86	242,54	
1 SCATTO MI MAN PC CONCH. Maniglione a scatto mignon placca chiusa con conchiglia Pull handle for sliding doors with sliding handle	55980605001	55980605003	55980605004	55980605007	55980605008	1
	142,25	144,04	142,25	144,04	142,25	
2 SCATTO MI MAN PC PY Maniglione a scatto mignon placca yale Pull handle for sliding door oval rose	55980605501	55980605503	55980605504	55980605507	55980605508	1
	129,75	131,84	129,75	131,84	129,75	
2 CONCH MAN SCATTO Conchiglia per maniglione a scatto handle for sliding door	55980680901	55980680903	55980680904	55980680907	55980680908	4
	13,84	14,03	13,84	14,03	13,84	

# EUROPA

ALLUMINIO

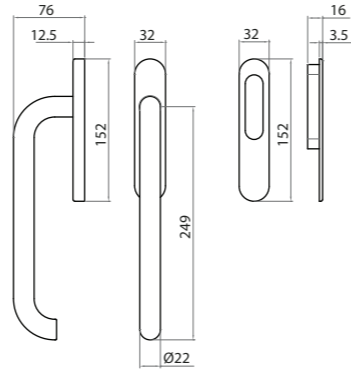

	F1	F4	GCTOL	F1-SAT	Conf. Pz.
<b>SCATTO MAN PC CONCH.</b>	77980601001	77980601004	77980601012	77980601033	
Maniglione a scatto placca chiusa con conchiglia	68,60	68,60	87,49	87,49	1
Pull handle for sliding door - closed plate					
<b>SCATTO MAN PC PY</b>	77980601501	77980601504	77980601512	77980601533	
Maniglione a scatto placca yale	60,56	60,56	77,23	77,23	1
Pull handle for sliding door w/cyl. Hole					
<b>SCATTO MANCP Q 10 PC</b>	77980620001	77980620004	77980620012	77980620033	
Coppia maniglioni a scatto Q10 placca chiusa	120,97	120,97	154,31	154,31	1
Pair pull handle with 10mm spindle + blind plate					
<b>SCATTO MANCP Q 10 PY</b>	77980620501	77980620504	77980620512	77980620533	
Coppia maniglioni a scatto Q10 placca yale	120,97	120,97	154,31	154,31	1
Pair pull handle with 10mm spindle + cyl. plate					
<b>CONCH MAN SCATTO</b>	77980680901	77980680904	77980680912	77980680933	
Conchiglia per maniglione a scatto	9,23	9,23	9,97	9,97	1
handle for sliding door					
<b>CONCH MAN SCATTO</b>	77980680901	77980680904	77980680912	77980680933	
Conchiglia per maniglione a scatto	9,23	9,23	9,97	9,97	1
handle for sliding door					

# 7900

ALLUMINIO

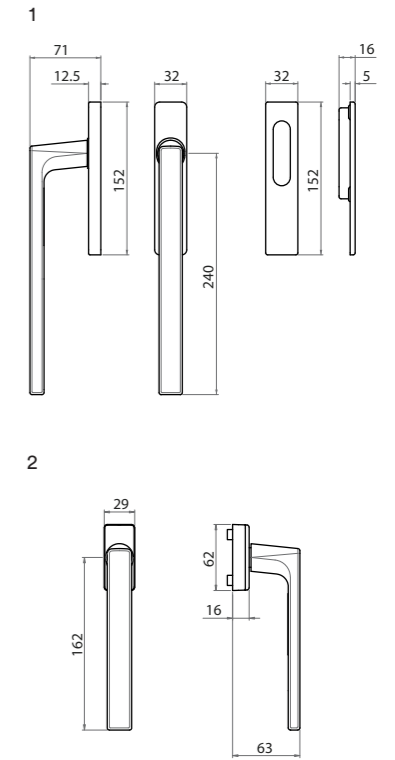

	F1	F3	F4	F9	Conf. Pz.
<b>1 SCATTO MAN PC CONCH.</b>	77900601001	77900601003	77900601004	77900601009	
Maniglione a scatto placca chiusa con conchiglia	45,50	44,64	44,64	51,34	1
Pull handle for sliding door - closed plate					
<b>1 SCATTO MAN PC PY</b>	77900601501	77900601503	77900601504	77900601509	
Maniglione a scatto placca yale	39,56	39,56	39,56	45,48	1
Pull handle for sliding door w/cyl. Hole					
<b>1 SCATTO MANCP Q 10 PC</b>	77900620001	77900620003	77900620004	77900620009	
Coppia maniglioni a scatto Q10 placca chiusa	76,26	76,26	76,26	87,69	1
Pair pull handle with 10mm spindle + blind plate					
<b>1 SCATTO MANCP Q 10 PY</b>	77900620501	77900620503	77900620504	77900620509	
Coppia maniglioni a scatto Q10 placca yale	76,26	76,26	76,26	87,69	1
Pair pull handle with 10mm spindle + cyl. Plate					
<b>2 COMPLANARE DKX40 C/BUS</b>	77900554201	77900554203	77900554204	77900554209	
Maniglione dk per complanare	9,92	9,92	9,92	11,43	1
window handle with 7mm spindle for sliding door					

	RAL9010	GCTOL	ANO	F1-SAT	Conf. Pz.
<b>1 SCATTO MAN PC CONCH.</b>	77900601007	77900601012	77900601016	77900601033	
Maniglione a scatto placca chiusa con conchiglia	47,33	62,83	47,33	62,00 ⚡	1
Pull handle for sliding door - closed plate					
<b>1 SCATTO MAN PC PY</b>	77900601507	77900601512	77900601516	77900601533	
Maniglione a scatto placca yale	40,72	55,27	40,72	45,88	1
Pull handle for sliding door w/cyl. Hole					
<b>1 SCATTO MANCP Q 10 PC</b>	77900620007	77900620012	77900620016	77900620033	
Coppia maniglioni a scatto Q10 placca chiusa	80,85	106,54	80,85	88,46	1
Pair pull handle with 10mm spindle + blind plate					
<b>1 SCATTO MANCP Q 10 PY</b>	77900620507	77900620512	77900620516	77900620533	
Coppia maniglioni a scatto Q10 placca yale	80,85	106,54	80,85	88,46	1
Pair pull handle with 10mm spindle + cyl. plate					
<b>2 COMPLANARE DKX40 C/BUS</b>	77900554207	77900554212	77900554216	77900554233	
Maniglione dk per complanare	10,80	15,46	10,80	13,44	1
window handle with 7mm spindle for sliding door					

⚡ Servizio G48: Articolo a magazzino e disponibile entro 48 dall'elaborazione dell'ordine. In base a disponibilita' e condizioni di vendita.  
G48 service: Item in stock and available within 48 hours of order processing. Based on availability and sales conditions.

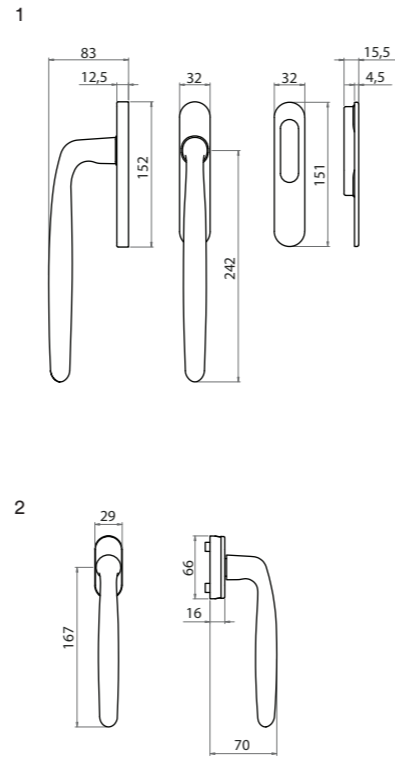

	F1	F3	F4	F9	Conf. Pz.
1 SCATTO MAN PC CONCH. Maniglione a scatto placca chiusa con conchiglia Pull handle for sliding door - closed plate	72005601001 47,99	72005601003 47,99	72005601004 47,99	72005601009 55,18	1
1 SCATTO MAN PC PY Maniglione a scatto placca yale Pull handle for sliding door w/cyl. Hole	72005601501 40,82	72005601503 40,82	72005601504 40,82	72005601509 46,93	1
1 SCATTO MANCP Q 10 PC Coppia maniglioni a scatto Q10 placca chiusa Pair pull handle with 10mm spindle + blind plate	72005620001 76,92	72005620003 76,92	72005620004 76,92	72005620009 88,45	1
1 SCATTO MANCP Q 10 PY Coppia maniglioni a scatto Q10 placca yale Pair pull handle with 10mm spindle + cyl. Plate	77905620501 76,92	77905620503 76,92	77905620504 76,92	77905620509 88,45	1
2 COMPLANARE DKX40 C/BUS Maniglione dk per complanare window handle with 7mm spindle for sliding door	72005552201 9,71	72005552203 9,71	72005552204 9,71	72005552209 11,16	1

	RAL9010	GCTOL	ANO	F1-SAT	Conf. Pz.
1 SCATTO MAN PC CONCH. Maniglione a scatto placca chiusa con conchiglia Pull handle for sliding door - closed plate	72005601007 49,46	72005601012 58,88	72005601016 49,46	72005601033 54,45	1
1 SCATTO MAN PC PY Maniglione a scatto placca yale Pull handle for sliding door w/cyl. Hole	72005601507 42,30	72005601512 47,99	72005601516 42,30	72005601533 46,07	1
1 SCATTO MANCP Q 10 PC Coppia maniglioni a scatto Q10 placca chiusa Pair pull handle with 10mm spindle + blind plate	72005620007 78,85	72005620012 90,35	72005620016 78,85	72005620033 85,16	1
1 SCATTO MANCP Q 10 PY Coppia maniglioni a scatto Q10 placca yale Pair pull handle with 10mm spindle + cyl. plate	77905620507 78,85	77905620512 90,35	77905620516 78,85	77905620533 85,16	1
2 COMPLANARE DKX40 C/BUS Maniglione dk per complanare window handle with 7mm spindle for sliding door	72005552207 10,12	72005552212 14,38	72005552216 10,12	77900552233 12,46	1

# 3

**Accessori per  
porte e finestre**

**Accessories for  
doors and windows**

318 Rosette Ottone / Brass roses  
326 Nottolini Ottone / Brass knobs  
329 Rosette e placche Alluminio / Aluminum roses and plates  
342 Giochi DK / DK mechanism  
343 Ferri / Spindles  
346 Viti / Screws

## ROS 45X9

OTTONE



FORO/HOLE Ø16MM

- SUPPORTO IN POLIMERO
- MOLLA TRADIZIONALE DX O SX
- MANIGLIA SOLIDALE
- NON PREDISPOSTA PER VITI PASSANTI

- PLASTIC SUPPORT
- STANDARD SPRING LH/RH
- HANDLE FIXED ON THE ROSE
- NOT AVAILABLE FOR THROUGH BOLTS

	OLV	OCS	OGV	OCL	OS	Conf. Pz.
ROS TONDA COP	55748531001	55748531003	55748531004	55748531007	55748531008	10
MILENA ROS TONDA COP	3,05	4,17	3,05	4,17	3,05	10
<i>Rund rose</i>						
BOC PAT	55748631001	55748631003	55748631004	55748631007	55748631008	10
MILENA BOC TONDA PAT	3,05	4,17	3,05	4,17	3,05	10
<i>Round key escutcheon</i>						
BOC YALE	55748635001	55748635003	55748635004	55748635007	55748635008	10
MILENA BOC TONDA YAL	3,05	4,17	3,05	4,17	3,05	10
<i>Round cyl. Escutcheon</i>						

## ROS 50x7-0005

OTTONE

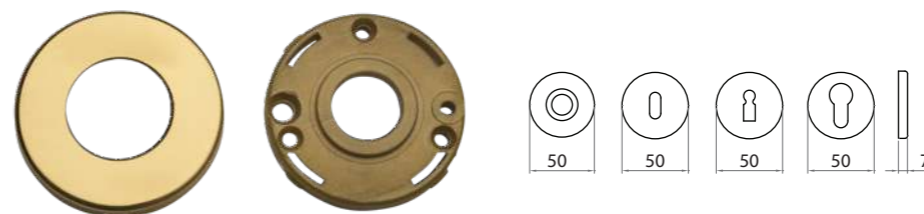

FORO/HOLE Ø16-18MM

- SUPPORTO IN POLIMERO
- MOLLA TRADIZIONALE DX O SX
- MANIGLIA SOLIDALE
- PREDISPOSTA PER VITI PASSANTI INT. MM 38 AUTOFIETTANTI O METRICHE

- PLASTIC SUPPORT
- STANDARD SPRING LH/RH
- HANDLE FIXED ON THE ROSE
- AVAILABLE FOR THROUGH BOLTS - SELF DRILLING SCREW/METRIC SCREWS

### SISTEMI DI MONTAGGIO DISPONIBILI



VL: VITI LEGNO  
VL: WOOD SCREWS

VPA: VITI PASSANTI AUTOFIETTANTI  
VPA: THROUGH BOLTS SELF-DRILLING SCREWS

VPM: VITI PASSANTI METRICHE  
VPM: THROUGH BOLTS METRIC SCREWS

ATTACCO RAPIDO  
FAST CONNECTION

RIF. CATALOGO

DISPONIBILE SU RICHIESTA

DISPONIBILE SU RICHIESTA

DISPONIBILE SU RICHIESTA

## ROS 45X9 NOVECENTO

OTTONE



FORO/HOLE Ø16MM

- SUPPORTO IN POLIMERO
- MOLLA TRADIZIONALE DX O SX
- MANIGLIA SOLIDALE
- NON PREDISPOSTA PER VITI PASSANTI

- PLASTIC SUPPORT
- STANDARD SPRING LH/RH
- HANDLE FIXED ON THE ROSE
- NOT AVAILABLE FOR THROUGH BOLTS

	OBR	OLV	OCL	OLD	OFA	Conf. Pz.
ROS 45x9 C/RIGA	55198531000	55198531001	55198531007	55198531028	55198531029	10
NOVECENTO ROS 45X9 FD22 C/RIGA	3,41	4,02	4,43	4,02	4,68	10
<i>Rund rose with line</i>						
BOC PAT	55198631000	55198631001	55198631007	55198631028	55198631029	10
NOVECENTO BOC 45X9 PAT C/RIGA	3,41	4,02	4,43	4,02	4,68	10
<i>Round key escutcheon</i>						
BOC YALE	55198635000	55198635001	55198635007	55198635028	55198635029	10
NOVECENTO BOC 45X9 YALE C/RIGA	3,41	4,02	4,43	4,02	4,68	10
<i>Round cyl. Escutcheon</i>						

	OLV	OCS	OGV	OCL	OS	Conf. Pz.
ROS TONDA COP 50	55748531301	55748531303	55748531304	55748531307	55748531308	10
ROS.50x7 COPRIVITE	3,42	4,54	3,42	4,54	3,42	10
<i>Rund rose</i>						
BOC PAT	55748631301	55748631303	55748631304	55748631307	55748631308	10
BOC.50x7 SINGOLA PAT	3,42	4,54	3,42	4,54	3,42	10
<i>Round key escutcheon</i>						
BOC BB	55748631201	55748631203	55748631204	55748631207	55748631208	10
BOC.50x7 SINGOLA BB	3,42	4,54	3,42	4,54	3,42	10
<i>Escutcheon BB key hole</i>						
BOC YALE	55748635301	55748635303	55748635304	55748635307	55748635308	10
BOC.50x7 SINGOLA YALE	3,42	4,54	3,42	4,54	3,42	10
<i>Round cyl. Escutcheon</i>						

	ONS	OLD	OFA	ONL	OANT	Conf. Pz.
ROS TONDA COP 50	55748531327	55748531328	55748531329	55748531330	55748531342	10
ROS.50x7 COPRIVITE	4,46	3,42	4,76	4,46	3,20	10
<i>Round rose</i>						
BOC PAT	55748631327	55748631328	55748631329	55748631330	55748631342	10
BOC.50x7 SINGOLA PAT	4,46	3,42	4,76	4,46	3,20	10
<i>Round key escutcheon</i>						
BOC BB	55748631227	55748631228	55748631229	55748631230	55748631242	10
BOC.50x7 SINGOLA BB	4,46	3,42	4,76	4,46	3,20	10
<i>Escutcheon BB key hole</i>						
BOC YALE	55748635327	55748635328	55748635329	55748635330	55748635342	10
BOC.50x7 SINGOLA YALE	4,46	3,42	4,76	4,46	3,20	10
<i>Round cyl. Escutcheon</i>						

## ROS 545

OTTONE



FORO/HOLE Ø16MM

- SUPPORTO IN POLIMERO
- MOLLA TRADIZIONALE DX O SX
- MANIGLIA SOLIDALE
- PREDISPOSTA PER VITI PASSANTI INTER. MM 38 AUTOFIETTANTI O METRICHE

- PLASTIC SUPPORT
- STANDARD SPRING LH/RH
- HANDLE FIXED ON THE ROSE
- AVAILABLE FOR THROUGH BOLTS - SELF DRILLING SCREW/METRIC SCREWS

	OLS	ONL/ONS	OCL/OCS	Conf. Pz.
ROS	R054553106502	R054553106557	R054553106559	10
545 SINGOLA ROS.F16 COLLO 24	2,98	3,57	3,42	10
<i>Rund rose</i>				
BOC PAT	R054563106502	R054563106557	R054563106559	10
545 SINGOLA BOC.PAT	2,98	3,57	3,42	10
<i>Round key escutcheon</i>				
BOC YALE	R054563506502	R054563506557	R054563506559	10
545 SINGOLA BOC.PZ	2,98	3,57	3,42	10
<i>Round cyl. Escutcheon</i>				



## ROS 52x10-575

OTTONE



- SUPPORTO IN POLIMERO CON MOLLA
- AMBIDESTRA INSERITA
- MANIGLIA STACCATA
- PREDISPOSTA PER VITI PASSANTI INT. MM 38 AUTOFILETTANTI O METRICHE
- PLASTIC SUPPORT WITH SPRING LOADED LH/RH
- DETACHED HANDLE
- AVAILABLE FOR THROUGH BOLTS - SELF DRILLING SCREW/METRIC SCREWS

	ONS	OLD	OFA	ONL	OANT	Conf. Pz.
ROS TONDA COP 50	55748531327	55748531328	55748531329	55748531330	55748531342	
ROS.50x7 COPRIVITE	4,46	3,42	4,76	4,46	3,20	10
Round rose						
BOC PAT	55748631327	55748631328	55748631329	55748631330	55748631342	
BOC.50x7 SINGOLA PAT	4,46	3,42	4,76	4,46	3,20	10
Round key escutcheon						
BOC BB	55748631227	55748631228	55748631229	55748631230	55748631242	
BOC.50x7 SINGOLA BB	4,46	3,42	4,76	4,46	3,20	10
Escutcheon BB key hole						

## ROS GOLF

OTTONE



- SUPPORTO IN OTTONE
- MOLLA TRADIZIONALE DX O SX
- MANIGLIA SOLIDALE
- NON PREDISPOSTA PER VITI PASSANTI
- BRASS SUPPORT
- STANDARD SPRING LH/RH
- HANDLE FIXED ON THE ROSE
- NOT AVAILABLE FOR THROUGH BOLTS

	OLV	OCS	OCL	Conf. Pz.
ROS	55148531001	55148531003	55148531007	
GOLF ROS	12,20	14,28	14,28	10
Round rose				
BOC PAT	55148631001	55148631003	55148631007	
GOLF BOC PAT	12,20	14,28	14,28	10
Round key escutcheon				
BOC YALE	55148635001	55148635003	55148635007	
GOLF BOC YALE	12,20	14,28	14,28	10
Round cyl. Escutcheon				

## ROS 61

OTTONE



- MONOBLOCCO
- NON PREDISPOSTA PER MOLLA
- MANIGLIA STACCATA
- PREDISPOSTA PER VITI PASSANTI INT. MM 38 METRICHE
- SOLID ROSE
- NOT AVAILABLE FOR SPRING
- DETACHED HANDLE
- AVAILABLE FOR THROUGH BOLTS METRIC SCREWS

	OLV	Conf. Pz.
ROS	R006100000001	
61 ROSETTA OT F.20 C/FV	7,29	10
Round rose		
BOC BB	R006264126501	
61 SINGOLA BOC.BB VV	7,29	10
Escutcheon BB key hole		
BOC PZ	R006264506501	
61 SINGOLA BOC.PZ VV	7,29	10
Round cyl. Escutcheon		

## ROS 45x10 V.V.

OTTONE



- MONOBLOCCO
- NON PREDISPOSTA PER MOLLA
- MANIGLIA SOLIDALE
- NON PREDISPOSTA PER VITI PASSANTI
- SOLID ROSE
- NOT AVAILABLE FOR SPRING
- FIXED HANDLE
- NOT AVAILABLE FOR THROUGH BOLTS

	OBR	OLV	OCL	OLD	OFA	Conf. Pz.
ROS	55198541000	55198541001	55198541007	55198541028	55198541029	
ROS.900 MM.45 V.V.	7,89	7,89	8,63	7,89	9,82	10
Round rose						
BOC PAT	55198641000	55198641001	55198641007	55198641028	55198641029	
BOC.900 MM45 V.V. PATENT	7,89	7,89	8,63	7,89	9,82	10
Round key escutcheon						
BOC YALE	55198645000	55198645001	55198645007	55198645028	55198645029	
BOC.900 MM45 V.V. YALE	7,89	7,89	8,63	7,89	9,82	10
Round cyl. Escutcheon						

## ROS 45x45x10

OTTONE

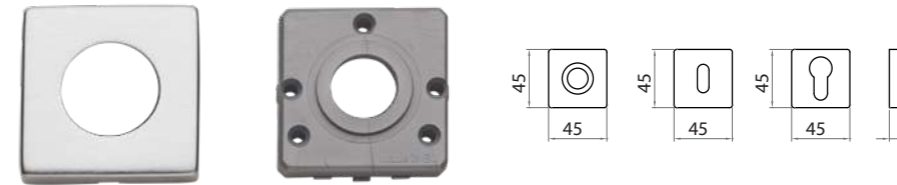

- SUPPORTO IN POLIMERO
- MOLLA TRADIZIONALE DX O SX
- MANIGLIA SOLIDALE
- NON PREDISPOSTA PER VITI PASSANTI
- PLASTIC SUPPORT
- STANDARD SPRING LH/RH
- FIXED HANDLE
- AVAILABLE FOR THROUGH BOLTS

	OCS	OCL	Conf. Pz.
ROS	55448553003	55448553007	
ROS. Q45X45 QUADRA ASSEMB. F16	3,57	3,57	10
square rose			
BOC PAT	55448653003	55448653007	
BOC.45X45 PAT	3,57	3,57	10
square key escutcheon			
BOC YALE	55448655503	55448655507	
BOC.45X45 YALE	3,57	3,57	10
square cyl. Escutcheon			

# ROS 50x50x10 - 574

OTTONE / ALLUMINIO

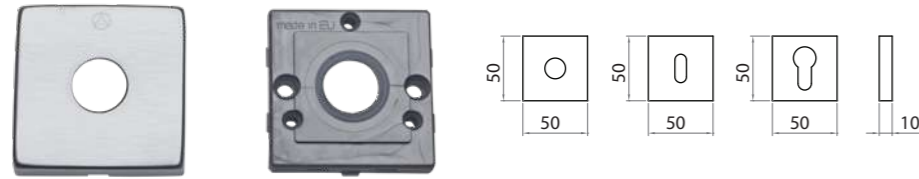

- SUPPORTO IN POLIMERO
- MOLLA TRADIZIONALE DX O SX
- MANIGLIA SOLIDALE
- PREDISPOSTA PER VITI PASSANTI INT. MM 38 AUTOFIETTANTI O METRICHE

- PLASTIC SUPPORT
- STANDARD SPRING LH/RH
- HANDLE FIXED ON THE ROSE
- AVAILABLE FOR THROUGH BOLTS - SELF DRILLING SCREW/METRIC SCREWS

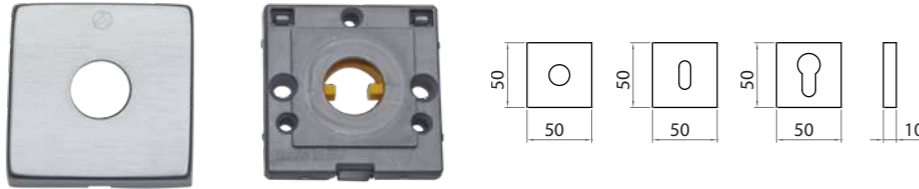

- SUPPORTO IN POLIMERO CON MOLLA AMBIDESTRA INSERITA
- MANIGLIA STACCATA
- PREDISPOSTA PER VITI PASSANTI INT. MM 38 AUTOFIETTANTI O METRICHE

- PLASTIC SUPPORT WITH SPRING LOADED LH/RH
- DETACHED HANDLE
- AVAILABLE FOR THROUGH BOLTS - SELF DRILLING SCREW/METRIC SCREWS

	OLV	OCS	OCL	ONS	Conf. Pz.
ROS	55448551201	55448551203	55448551207	55448551227	10
ROS.50X50 QUADRA ASSEMBL. F16 collo 21 singola s/molla square rose	5,51	6,25	6,25	6,55	10
ROS	55448551001	55448551003	55448551007	55448551027	10
ROS.50X50 QUADRA ASSEMBL. F16 collo 21 singola c/molla square rose	9,23	9,97	9,97	10,27	10
BOC PAT	55448651001	55448651003	55448651007	55448651027	10
BOC.50X50 QUADRA ASSEMBL. PAT square key escutcheon	5,51	6,25	6,25	6,55	10
BOC YALE	55448655001	55448655003	55448655007	55448655027	10
BOC.50X50 QUADRA ASSEMBL. YAL square cyl. Escutcheon	5,51	6,25	6,25	6,55	10

# ROS 544

OTTONE

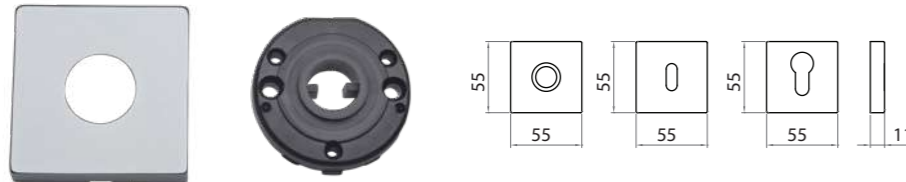

- SUPPORTO IN POLIMERO CON MOLLA AMBIDESTRA INSERITA
- MANIGLIA STACCATA
- PREDISPOSTA PER VITI PASSANTI INT. MM 38 AUTOFIETTANTI O METRICHE

- PLASTIC SUPPORT WITH SPRING LOADED LH/RH
- DETACHED HANDLE
- AVAILABLE FOR THROUGH BOLTS - SELF DRILLING SCREW/METRIC SCREWS

	ZCL	ZCS	ZNS	ZNL	Conf. Pz.
ROS	R054400006507	R054400006513	R054400006527	R054400006530	10
ROS 544 ZAMA C/M DX/SX square rose	11,61	11,61	12,05	12,05	10
BOC BB	R054465106507	R054465106513	R054465106527	R054465106530	10
544 SINGOLA BOC.PAT RASATA Escutcheon BB key hole	7,89	7,89	8,33	8,33	10
BOC PZ	R054465506507	R054465506513	R054465506527	R054465506530	10
544 SINGOLA BOC.PZ RASATA Round cyl. Escutcheon	7,89	7,89	8,33	8,33	10

# ROS 30x30

OTTONE

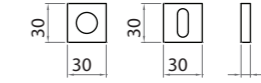

- SUPPORTO IN POLIMERO CON MOLLA AMBIDESTRA INSERITA
- MANIGLIA STACCATA
- NON PREDISPOSTA PER VITI PASSANTI

- PLASTIC SUPPORT WITH SPRING LOADED LH/RH
- DETACHED HANDLE
- NOT AVAILABLE FOR THROUGH BOLTS

	OCS	OCL	F1-SAT	Conf. Pz.
ROS	55448552803	55448552807	77498552833	10
ROS.30x30 QUADRA F.16 OT C/MOLLA square rose	5,46	5,46	5,21	10
BOC PAT	55448652803	55448652807	77498652833	10
BOC.30X30 QUADRA ASSEMBL. PAT	3,57	3,57	3,27	10

# ROS 30x30

OTTONE

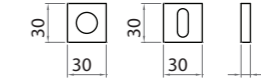

- SUPPORTO IN POLIMERO CON MOLLA AMBIDESTRA INSERITA
- MANIGLIA STACCATA
- NON PREDISPOSTA PER VITI PASSANTI

- PLASTIC SUPPORT WITH SPRING LOADED LH/RH
- DETACHED HANDLE
- NOT AVAILABLE FOR THROUGH BOLTS

	OCS	OCL	F1-SAT	Conf. Pz.
ROS	55448552803	55448552807	77498552833	10
ROS.30x30 QUADRA F.16 OT C/MOLLA square rose	5,46	5,46	5,21	10
BOC PAT	55448652803	55448652807	77498652833	10
BOC.30X30 QUADRA ASSEMBL. PAT	3,57	3,57	3,27	10

# ROS 30x60-0006

OTTONE



D. FORO 24MM

D. FORO 16MM

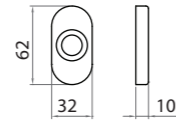

- SUPPORTO IN POLIMERO
- PREDISPOSTA PER MOLLA TRADIZIONALE DX O SX CON MANIGLIA SOLIDALE
- PLASTIC SUPPORT
- AVAILABLE FOR STANDARD SPRING LH/RH



D. FORO 16MM

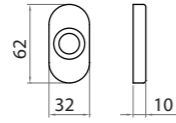

- SUPPORTO IN POLIMERO CON MOLLA AMBIDESTRA INSERITA
- MANIGLIA STACCATA
- PLASTIC SUPPORT WITH SPRING LOADED LH/RH
- DETACHED HANDLE

	OLV	OCS	OGV	OCL	OS	Conf. Pz.
ROS	55498521001	55498521003	55498521004	55498521007	55498521008	
ROS OVALE COP.30X60 F24 c/inserto F16 oval rose	8,18	9,23	8,18	9,23	8,18	10
ROS	55498521301	55498521303	55498521304	55498521307	55498521308	
ROS OVALE COP.30X60 c/molla dx/sx oval rose	10,66	11,71	10,66	11,71	10,66	10
BOC PAT	55498621001	55498621003	55498621004	55498621007	55498621008	
BOC COP OVALE PAT oval key escutcheon	8,18	9,23	8,18	9,23	8,18	10
BOC YALE	55498625001	55498625003	55498625004	55498625007	55498625008	
BOC COP OVALE YAL oval cyl. Escutcheon	8,18	9,23	8,18	9,23	8,18	10

# ROS 30x60-00C6



D. FORO 24MM

D. FORO 16MM

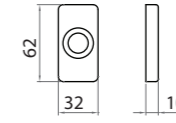

- SUPPORTO IN POLIMERO
- MANIGLIA STACCATA
- PREDISPOSTA PER MOLLA TRADIZIONALE DX O SX CON MANIGLIA SOLIDALE
- PLASTIC SUPPORT
- DETACHED HANDLE
- AVAILABLE FOR STANDARD SPRING LH/RH WITH FIXED HANDLE



D. FORO 16MM

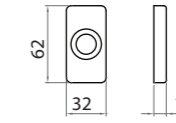

- SUPPORTO IN POLIMERO CON MOLLA AMBIDESTRA INSERITA
- MANIGLIA STACCATA
- PLASTIC SUPPORT WITH SPRING LOADED LH/RH
- DETACHED HANDLE

	OLV	OCS	OCL	Conf. Pz.
ROS	55448511501	55448511503	55448511507	
ROS RETT. 30X60x9,5 FD24 s/molla Rectangular rose	5,21	5,80	5,80	10
ROS	55448511601	55448511603	55448511607	
ROS RETT. 30X60x9,5 FD16 c/molla Rectangular rose	7,69	8,28	8,28	10
BOC PATENT	55448611501	55448611503	55448611507	
BOC.30X60 RETT. ASSEMBL. PAT rectangular key escutcheon	5,21	5,80	5,80	10
BOC YALE	55448615501	55448615503	55448615507	
BOC.30X60 RETT. ASSEMBL. YALE rectangular cyl. Escutcheon	5,21	5,80	5,80	10

## MILENA

OTTONE

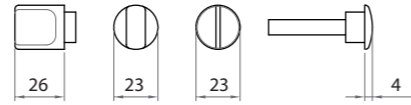

	OGV	OCL	OS	ONS	ONL	Conf. Pz.
NOTT WC Q6	55448229004	55448229007	55448229008	55448229027	55448229030	2
MILENA NOTT WC Q6 Toilet set - spindle 6 mm without rose	12,20	16,37	12,20	17,11	16,37	

## MEZZALUNA

OTTONE

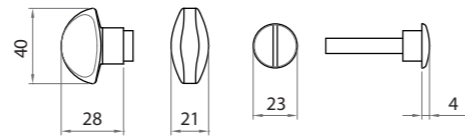

	ZCL	GCTOL	ZCS	ZNS-M9	ZNL-M7	Conf. Pz.
NOTT WC Q6	66748229007	66748229012	66748229013	66748229027	66748229030	2
MEZZALUNA+MILENA NOTT. WC Q6 Toilet set - spindle 6 mm without rose	13,98	13,42	13,32	14,79	13,98	
NOTT WC Q8	66748229807	66748229812	66748229813	66748229827	66748229830	2
MEZZALUNA+MILENA NOTT. WC Q8 Toilet set - spindle 8 mm without rose	13,98	13,42	13,32	14,79	13,98	

## GOLF

OTTONE

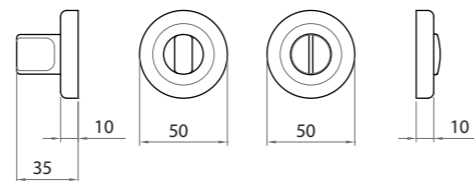

	OLV	OCS	OCL	Conf. Pz.
NOTT RWC	55148638001	55148638003	55148638007	2
GOLF NOTT RWC Q6 Toilet set - spindle 8 mm without rose	38,69	46,72	46,72	

## MILENA

OTTONE

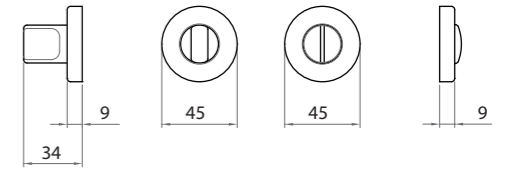

	OLV	OCS	OGV	OCL	OS	Conf. Pz.
NOTT RWC 45x9	55448638001	55448638003	55448638004	55448638007	55448638008	2
MILENA NOTT RWC Toilet set Q 6 with rose	13,55	17,61	13,55	17,61	13,55	
NOTT RWC 50x7	55448638301	55448638303	55448638304	55448638307	55448638308	2
MILENA NOTT RWC50x7 Q6 Toilet set Q 6 with rose	13,95	18,10	13,95	18,10	13,95	
NOTT RWC 50x10	55448639801	55448639803	55448639804	55448639807	55448639808	2
MILENA NOTT RWC52x10 Toilet set Q 6 with rose	14,34	18,59	14,34	18,59	14,44	

## NOVECENTO

OTTONE

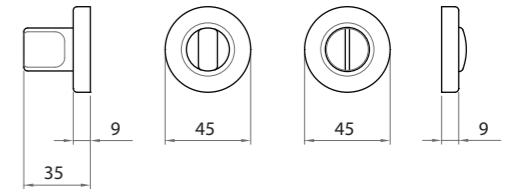

	OBR	OLV	OCL	OLD	OFA	Conf. Pz.
NOTT RWC	55198638000	55198638001	55198638007	55198638028	55198638029	2
NOVECENTO NOTT RWC Toilet set - spindle 6 mm with rose	17,07	20,09	22,51	20,09	21,75	

## MILENA

OTTONE

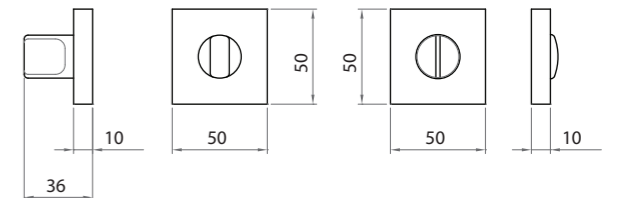

	OLV	OCS	OCL	ONS	Conf. Pz.
NOTT RWC	55448668001	55448668003	55448668007	55448668027	2
MILENA ROS.50X50 QUADRA CON NOTTOLINO Toilet set Q 6 with rose	19,27	21,58	21,58	22,32	

## FRAME

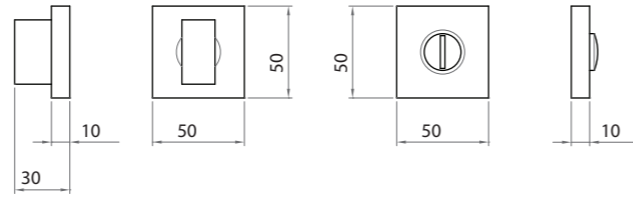

ALLUMINIO

	ACL	F1-SAT	Conf. Pz.
NOTT RWC NOTT. FRAME ROS."Q" ASSEMBL. Toilet set Q 6 with rose	77472658017	77472658033	2
	32,88	26,64	

## WING

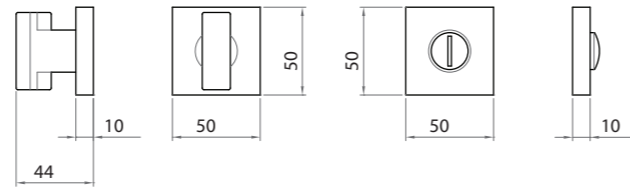

OTTONE

	ZCL	ZCS	Conf. Pz.
NOTT RWC NOTT. WING RQWC Toilet set Q 6 with rose	66792658007	66792658013	2
	31,40	31,40	

## ROS 50x50

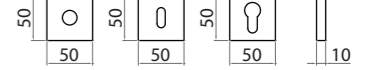
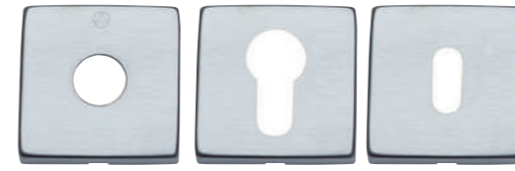

ALLUMINIO

	F1	F3	F4	F9	F1-SAT	Conf. Pz.
COPPIA ROS.Q 50x50 F.18 Coppia rosette quadre 50x50 F.18 pair of square roses 50x50 18mm hole	77498554001	77498554003	77498554004	77498554009	77498554033	10
	3,93	4,40	4,40	4,40	9,52	
ROS ROS.50X50 QUADRA ASSEMBL. F16 singola c/molla square rose	77498551001	77498551003	77498551004	77498551009	77498551033	10
					8,48	
COPPIA BOC.Q 50x50 PAT Coppia bocchette quadre 50x50 patent Pair square escutcheons 50x50 key hole	77498651101	77498651103	77498651104	77498651109	77498651133	10
	3,93	4,40	4,40	4,40	9,52	
COPPIA BOC.Q 50x50 YALE Coppia bocchette quadre 50x50 Yale Pair square escutcheons 50x50 cyl. hole	77498655101	77498655103	77498655104	77498655109	77498655133	10
	3,93	4,40	4,40	4,40	9,52	

## ROS 45x7



ALLUMINIO

	F3	F4	F9	GCTOL	F1-SAT	Conf. Pz.
COPPIA ROS 45x7 F.18 Coppia rosette 45x7 F.18 pair of round roses 45x7 18mm hole	77448531003	77448531004	77448531009	77448531012	77448531033	10
	2,32	2,32	2,32	4,18	1,60	
COPPIA BOC 45x7 PAT Coppia bocchette 45x7 patent Pair escutcheons 45x7 key hole	77448631003	77448631004	77448631009	77448631012	77448631033	10
	2,32	2,32	2,32	4,18	1,60	
COPPIA BOC 45x7 YALE Coppia bocchette 45x7 Yale Pair escutcheons 45x7 key hole	77448635003	77448635004	77448635009	77448635012	77448635033	10
	2,32	2,32	2,32	4,18	1,60	

## ROS 45x7 VITI A VISTA

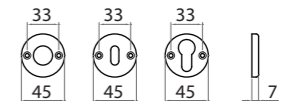

ALLUMINIO

	F1	F3	F4	F9	Conf. Pz.
COPPIA ROS 45x7 F.20 V.V. Coppia rosette 45x7 F.20 viti vista pair of round roses 45x7 18mm hole	77448541001	77448541003	77448541004	77448541009	10
	3,05	3,05	3,05	3,57	
COPPIA BOC 45x7 PAT V.V. Coppia bocchette 45x7 patent viti vista Pair escutcheons 45x7 key hole	77448641001	77448641003	77448641004	77448641009	10
	3,05	3,05	3,05	3,57	
COPPIA BOC 45x7 YALE V.V. Coppia bocchette 45x7 Yale viti vista Pair escutcheons 45x7 cyl. hole	77448645001	77448645003	77448645004	77448645009	10
	3,05	3,05	3,05	3,57	

# ROS 50x7

ALLUMINIO

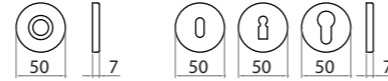

## SISTEMI DI MONTAGGIO DISPONIBILI

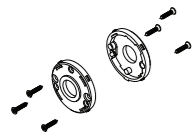

VL: VITI LEGNO  
VL: WOOD SCREWS

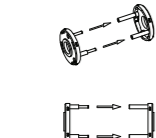

INT. MM38  
ATTACCO RAPIDO  
FAST CONNECTION

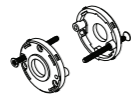

VPA: VITI PASSANTI AUTOFILETTANTI  
VPA: THROUGH BOLTS SELF-DRILLING  
SCREWS

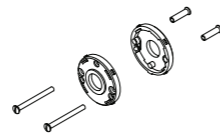

VPM: VITI PASSANTI METRICHE  
VPM: THROUGH BOLTS METRIC  
SCREWS

RIF. CATALOGO

RIF. CATALOGO

DISPONIBILE SU RICHIESTA

DISPONIBILE SU RICHIESTA

	F1	F3	F4	F9	GCTOL	F1-SAT	Conf. Pz.
COPPIA ROS. 50x7 F.18 Coppia rosette 50x7 F18 pair of round roses 50x7 18mm hole	77448531401	77448531403	77448531404	77448531409	77448531412	77448531433	10
	1,68	2,46	2,46	2,46	3,90	1,82	
COPPIA ROS. 50x7 F.18 Coppia rosette 50x7 F18 ATTACCO RAPIDO pair of round roses 50x7 18mm hole speed connection	77448531401AR	77448531403AR	77448531404AR	77448531409AR	77448531412AR	77448531433AR	10
	2,04	2,82	2,82	2,82	4,26	2,12	
COPPIA ROS. 50x7 F.16 Coppia rosette 50x7 F16 ATTACCO RAPIDO pair of round roses 50x7 16mm hole speed connection	77448532201AR	77448532203AR	77448532204AR	77448532209AR	77448532212AR	77448532233AR	10
	2,04	2,82	2,82	2,82	4,26	2,18	
COPPIA BOC 50x7 PAT Coppia bocchette 50x7 patent Pair escutcheons 50x7 key hole	77448631301	77448631303	77448631304	77448631309	77448631312	77448631333	10
	1,68	2,46	2,46	2,46	3,90	1,82	
COPPIA BOC 50x7 PAT Coppia bocchette 50x7 patent attacco rapido Pair escutcheons 50x7 key hole speed connection	77448631301AR	77448631303AR	77448631304AR	77448631309AR	77448631312AR	77448631333AR	10
	2,04	2,82	2,82	2,82	4,26	2,18	
COPPIA BOC 50x7 BB Coppia bocchette 50x7 BB Pair escutcheons 50x7 BB key hole	77448631701	77448631703	77448631704	77448631709	77448631712	77448631733	10
	1,68	2,46	2,46	2,46	3,90	1,82	
COPPIA BOC 50x7 YALE Coppia bocchette 50x7 Yale Pair escutcheons 50x7 cyl. hole	77448635401	77448635403	77448635404	77448635409	77448635412	77448635433	10
	1,68	2,46	2,46	2,46	3,90	1,82	
COPPIA BOC 50x7 YALE Coppia bocchette 50x7 Yale attacco rapido Pair escutcheons 50x7 cyl. Hole speed connection	77448635401AR	77448635403AR	77448635404AR	77448635409AR	77448635412AR	77448635433AR	10
	2,04	2,82	2,82	2,82	4,26	2,18	

# ROS 50x7 VITI A VISTA

ALLUMINIO

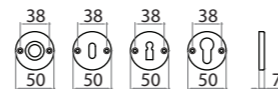
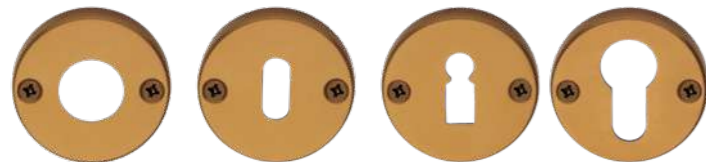

	F1	F3	F4	F9	Conf. Pz.
COPPIA ROS 50x7 F.20 V.V. Coppia rosette 50x7 F.20 viti vista pair of round roses 45x7 18mm hole	77448543001	77448543003	77448543004	77448543009	10
	1,36	2,32	2,32	2,32	
COPPIA BOC 50x7 PAT V.V. Coppia bocchette 50x7 patent viti vista Pair escutcheons 45x7 key hole	77448643001	77448643003	77448643004	77448643009	10
	1,36	2,32	2,32	2,32	
COPPIA BOC 50x7 YALE V.V. Coppia bocchette 50x7 Yale viti vista Pair escutcheons 50x7 cyl. hole	77448647001	77448647003	77448647004	77448647009	10
	1,36	2,32	2,32	2,32	
COPPIA BOC 50x7 BB V.V. Coppia bocchette 50x7 BB viti vista Pair escutcheons 50x7 BB hole	77448644001	77448644003	77448644004	77448644009	10
	1,36	2,32	2,32	2,32	

# ROS 52x10

ALLUMINIO



	F1	F3	F4	F9	GCTOL	F1-SAT	Conf. Pz.
COPPIA ROS. 52x10 F.18 Coppia rosette 52x10 F18 pair of round roses 52x7 18mm hole	77398531301	77398531303	77398531304	77398531309	77398531312	77398531333	10
	2,36	2,90	2,90	2,90	4,32	3,18	
COPPIA BOC 52x10 PAT Coppia bocchette 52x10 patent Pair escutcheons 52x10 key hole	77398631301	77398631303	77398631304	77398631309	77398631312	77398631333	10
	2,36	2,90	2,90	2,90	4,32	3,18	
COPPIA BOC 52x10 BB Coppia bocchette 52x10 BB Pair escutcheons 52x10 BB key hole	77398631701	77398631703	77398631704	77398631709	77398631712	77398631733	10
	2,36	2,90	2,90	2,90	4,32	3,18	
COPPIA BOC 52x10 YALE Coppia bocchette 52x10 Yale Pair escutcheons 52x10 cyl hole	77398635301	77398635303	77398635304	77398635309	77398635312	77398635333	10
	2,36	2,90	2,90	2,90	4,32	3,18	

# ROS 30x60

ALLUMINIO

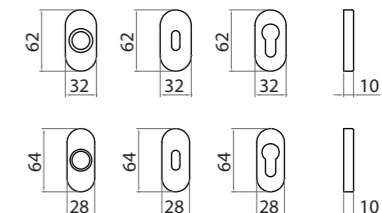
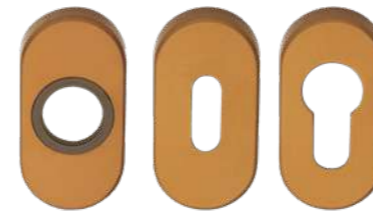

	F1	F3	F4	F9	GCTOL	F1-SAT	Conf. Pz.
COPPIA ROS 30x60 F.18 OVALE Coppia rosette 30x60 F.18 ovali pair of oval roses 30x60 18mm hole	77398521001	77398521003	77398521004	77398521009	77398521012	77398521033	10
	2,15	2,68	2,68	2,68	4,80	2,97	
COPPIA BOC 30x60 PAT OVALE Coppia bocchette 30x60 patent ovali Pair oval escutcheons 30x60 key hole	77398621001	77398621003	77398621004	77398621009	77398621012	77398621033	10
	2,15	2,68	2,68	2,68	4,80	2,97	
COPPIA BOC 30x60 YALE OVALE Coppia bocchette 30x60 Yale ovali Pair oval escutcheons 30x60 cyl. hole	77398625001	77398625003	77398625004	77398625009	77398625012	77398625033	10
	2,15	2,68	2,68	2,68	4,80	2,97	

## ROS 28x64

ALLUMINIO

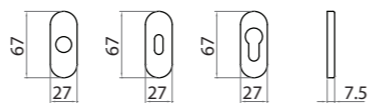

	F1	F3	F4	F9	GCTOL	F1-SAT	Conf. Pz.
COPPIA ROS 28x64 F.18 OVALE Coppia rosette 28x64 F.18 ovali pair of oval roses 28x64 18mm hole	77398522001	77398522003	77398522004	77398522009	77398522012	77398522033	10
COPPIA BOC 28X64 PAT OVALE Coppia bocchette 28x64 patent ovali Pair oval escutcheons 28x64 key hole	77398621501	77398621503	77398621504	77398621509	77398621512	77398621533	10
COPPIA BOC 28x64 YALE OVALE Coppia bocchette 28x64 Yale ovali Pair oval escutcheons 28x64 cyl. hole	77398625501	77398625503	77398625504	77398625509	77398625512	77398625533	10

## ROS 28x68 VITI A VISTA

ALLUMINIO

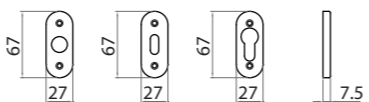

	F1	F3	F4	F9	Conf. Pz.
COPPIA ROS 28x68 F.20 OV V.V. Coppia rosette 28x68 F.20 ovali viti vista pair of oval roses 28x68 20mm hole	77448521001	77448521003	77448521004	77448521009	10
COPPIA BOC 28x68 PAT OV V.V. Coppia bocchette 28x68 patent ovali viti vista Pair oval escutcheons 28x64 key hole	77448621001	77448621003	77448621004	77448621009	10
COPPIA BOC 28x68 YALE OV V.V. Coppia bocchette 28x68 Yale ovali viti vista Pair oval escutcheons 28x64 cyl. hole	77448625001	77448625003	77448625004	77448625009	10

## ROS 30x60-00C6

ALLUMINIO

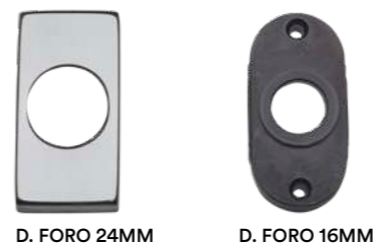

D. FORO 24MM

D. FORO 16MM

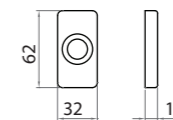

- SUPPORTO IN POLIMERO
- MANIGLIA STACCATA
- PREDISPOSTA PER MOLLA TRADIZIONALE DX O SX CON MANIGLIA SOLIDALE
- PLASTIC SUPPORT
- DETACHED HANDLE
- AVAILABLE FOR STANDARD SPRING LH/RH WITH FIXED HANDLE



D. FORO 16MM

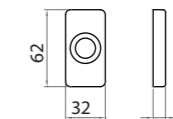

- SUPPORTO IN POLIMERO CON MOLLA AMBIDESTRA INSERITA
- MANIGLIA STACCATA
- PLASTIC SUPPORT WITH SPRING LOADED LH/RH
- DETACHED HANDLE

	F1	F3	F4	F9	GCTOL	F1-SAT	Conf. Pz.
ROS coppia coppia ROS.RETT 30x60x9.5 ASSEMBL. s/molla pair of rectangular rose	77498511501	77498511503	77498511504	77498511509	77498511512	77498511533	10
ROS coppia coppia ROS.RETT 30x60x9.5 ASSEMBL. c/molla dx/sx pair of rectangular roses with spring	77498511401	77498511403	77498511404	77498511409	77498511412	77498511433	10
BOC PATENT coppia coppia BOC.RETT PATENT 30x60x9.5 ASSEMBL. pair of rectangular key hole escutcheons	77498611501	77498611503	77498611504	77498611509	77498611512	77498611533	10
BOC YALE coppia coppia BOC.RETT YALE 30x60x9.5 ASSEMBL. pair of rectangular cyl.hole escutcheons	77498615501	77498615503	77498615504	77498615509	77498615512	77498615533	10

## ROS 50x50x10 - 574

ALLUMINIO

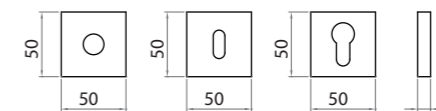

- SUPPORTO IN POLIMERO
- MOLLA TRADIZIONALE DX O SX
- MANIGLIA SOLIDALE
- PREDISPOSTA PER VITI PASSANTI INT. MM 38 AUTOFILETTANTI O METRICHE

- PLASTIC SUPPORT
- STANDARD SPRING LH/RH
- HANDLE FIXED ON THE ROSE
- AVAILABLE FOR THROUGH BOLTS - SELF DRILLING SCREW/METRIC SCREWS

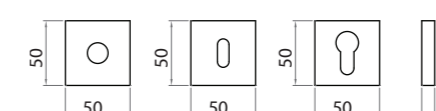

- SUPPORTO IN POLIMERO CON MOLLA AMBIDESTRA INSERITA
- MANIGLIA STACCATA
- PREDISPOSTA PER VITI PASSANTI INT. MM 38 AUTOFILETTANTI O METRICHE

- PLASTIC SUPPORT WITH SPRING LOADED LH/RH
- DETACHED HANDLE
- AVAILABLE FOR THROUGH BOLTS - SELF DRILLING SCREW/METRIC SCREWS

	ACL	F1-SAT	Conf. Pz.
ROS ROS.50X50 QUADRA ASSEMBL. F16 singola s/molla square rose	77498551817	77498551833	10
ROS ROS.50X50 QUADRA ASSEMBL. F16 singola c/molla square rose	77498551017	77498551033	10
BOC PAT BOC.50x50 PAT QUADRA ASSEMBL. square key escutcheon	77498651017	77498651033	10
BOC YALE BOC.50x50 YALE QUADRA ASSEMBL. square cyl. Escutcheon	77498655017	77498655033	10

# NOTTOLINI WC

ALLUMINIO

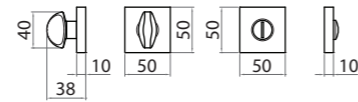

	F1	F3	F4	F9	Conf. Pz.
NOTT WC Q6 R50x50 Nottolino WC Q6 rosetta 50x50 Toilet set - spindle 6 mm with rose 50 x 50	77448668001	77448668003	77448668004	77448668009	10
	8,36	8,97	8,97	8,97	

# NOTTOLINI WC

ALLUMINIO

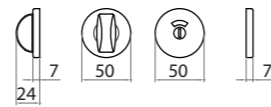
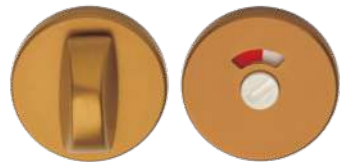

	F1	F3	F4	F9	Conf. Pz.
NOTT WC Q6 R50x7 Nottolino WC Q6 rosetta 50x7 Toilet set - spindle 6 mm with rose 50 x 7	77448638001	77448638003	77448638004	77448638009	10
	6,30	7,25	7,25	7,25	

# NOTTOLINI WC

ALLUMINIO

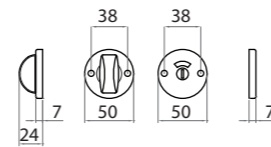
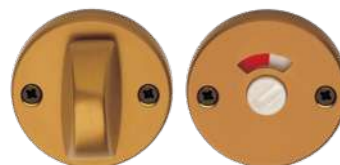

	F1	F3	F4	F9	Conf. Pz.
NOTT WC Q6 R50x7 V.V. Nottolino WC Q6 rosetta 50x7 viti vista Toilet set - spindle 6 mm with rose 50x7 visible screws	77448648001	77448648003	77448648004	77448648009	10
	6,30	7,25	7,25	7,25	

# PLACCA B

ALLUMINIO

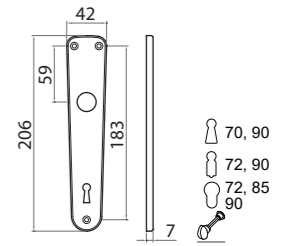

	F1	F3	F4	F9	Conf. Pz.
COPPIA PLACCHE B CH 90 PLACCA B P90 (coppia) pair of plate B hole CH 90	79010851001	79010851003	79010851004	79010851009	10
	3,60	4,36	4,36	4,36	
COPPIA PLACCHE B CH 70 PLACCA B P70 (coppia) pair of plate B hole CH 70	79010857001	79010857003	79010857004	79010857009	10
	3,60	4,36	4,36	4,36	
COPPIA PLACCHE B BB 72 PLACCA B P72 BB (coppia) pair of plate B hole BB 72	79010851601	79010851603	79010851604	79010851609	10
	3,60	4,36	4,36	4,36	
COPPIA PLACCHE B BB 90 PLACCA B P90 BB (coppia) pair of plate B hole BB 90	79010851201	79010851203	79010851204	79010851209	10
	3,60	4,36	4,36	4,36	
COPPIA PLACCHE B YALE 72 PLACCA B PY72 (coppia) pair of plate B hole cyl. 72	79010855601	79010855603	79010855604	79010855609	10
	3,60	4,36	4,36	4,36	
COPPIA PLACCHE B YALE 85 PLACCA B PY85 (coppia) pair of plate B hole cyl. 85	79010855001	79010855003	79010855004	79010855009	10
	3,60	4,36	4,36	4,36	
COPPIA PLACCHE B YALE 90 PLACCA B PY90 (coppia) pair of plate B hole cyl. 90	79010855901	79010855903	79010855904	79010855909	10
	3,60	4,36	4,36	4,36	
COPPIA PLACCHE B WC72 PLACCA B WC72 Q6 (coppia) pair of plate B hole wc 72	79010088601	79010088603	79010088604	79010088609	10
	8,57	9,46	9,46	9,46	
COPPIA PLACCHE B WC90 PLACCA B WC90 Q6 (coppia) pair of plate B hole wc 90	79010088001	79010088003	79010088004	79010088009	10
	8,57	9,46	9,46	9,46	



## PLACCA I

ALLUMINIO

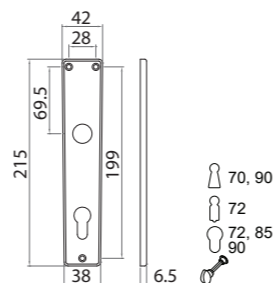

	F1	F3	F4	F9	Conf. Pz.
COPPIA PLACCHE I CH 90 PLACCA I P90 (coppia) pair of plate I hole CH 90	79060851001	79060851003	79060851004	79060851009	10
COPPIA PLACCHE I CH 70 PLACCA I P70 (coppia) pair of plate I hole CH 70	79060857001	79060857003	79060857004	79060857009	10
COPPIA PLACCHE I BB 72 PLACCA I P72 BB (coppia) pair of plate I hole BB 72	79060851601	79060851603	79060851604	79060851609	10
COPPIA PLACCHE I BB 90 PLACCA I P90 BB (coppia) pair of plate I hole BB 90	79060851201	79060851203	79060851204	79060851209	10
COPPIA PLACCHE I YALE 72 PLACCA I PY72 (coppia) pair of plate I hole cyl. 72	79060855601	79060855603	79060855604	79060855609	10
COPPIA PLACCHE I YALE 85 PLACCA I YA85 (coppia) pair of plate I hole cyl. 85	79060855001	79060855003	79060855004	79060855009	10
COPPIA PLACCHE I YALE 90 PLACCA I PY90 (coppia) pair of plate I hole cyl. 90	79060855901	79060855903	79060855904	79060855909	10
COPPIA PLACCHE I WC72 PLACCA I WC72 Q6 (coppia) pair of plate I hole wc 72	79060088601	79060088603	79060088604	79060088609	10
COPPIA PLACCHE I WC90 PLACCA I WC90 Q6 (coppia) pair of plate I hole wc 90	79060088001	79060088003	79060088004	79060088009	10

## PLACCA S2

ALLUMINIO

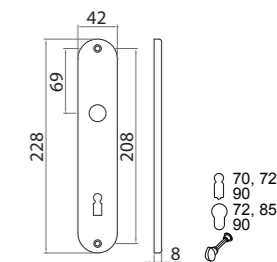

	F1	F3	F4	F9	Conf. Pz.
COPPIA PLACCHE S 2FV BB 70 PLACCA S P70BB 2VITI (coppia) pair of plate S 2FV hole BB 70	79120857201	79120857203	79120857204	79120857209	10
COPPIA PLACCHE S 2FV BB 72 PLACCA S P72BB 2VITI (coppia) pair of plate S 2FV hole BB 72	79120851601	79120851603	79120851604	79120851609	10
COPPIA PLACCHE S 2FV BB 90 PLACCA S P90BB 2VITI (coppia) pair of plate S 2FV hole BB90	79120851201	79120851203	79120851204	79120851209	10
COPPIA PLACCHE S 2FV YALE 72 PLACCA S PY72 2VITI (coppia) pair of plate S 2FV hole cyl.72	79120855601	79120855603	79120855604	79120855609	10
COPPIA PLACCHE S 2FV YALE 85 PLACCA S YA85 2VITI (coppia) pair of plate S 2FV hole cyl.85	79120855001	79120855003	79120855004	79120855009	10
COPPIA PLACCHE S 2FV YALE 90 PLACCA S PY90 2VITI (coppia) pair of plate S 2FV hole cyl.90	79120855901	79120855903	79120855904	79120855909	10
COPPIA PLACCHE S 2FV WC72 PLACCA S WC72 Q6 (coppia) pair of plate S 2FV wc 72	79120088601	79120088603	79120088604	79120088609	10
COPPIA PLACCHE S 2FV WC90 PLACCA S WC90 Q6 (coppia) pair of plate S 2FV wc 90	79120088001	79120088003	79120088004	79120088009	10

# PLACCA S4



ALLUMINIO

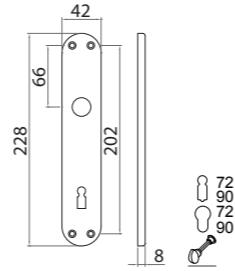

	F1	F3	F4	F9	Conf. Pz.
COPPIA PLACCHE S 4FV BB 72 PLACCA S P72BB 4VITI (coppia) pair of plate S 4FV hole BB72	79130851601	79130851603	79130851604	79130851609	10
COPPIA PLACCHE S 4FV BB 90 PLACCA S P90BB 4VITI (coppia) pair of plate S 4FV hole BB90	79130851201	79130851203	79130851204	79130851209	10
COPPIA PLACCHE S 4FV YALE 72 PLACCA S PY72 4VITI (coppia) pair of plate S 4FV hole cyl. 72	79130855601	79130855603	79130855604	79130855609	10
COPPIA PLACCHE S 4FV YALE 90 PLACCA S PY90 4VITI (coppia) pair of plate S 4FV hole cyl. 90	79130855901	79130855903	79130855904	79130855909	10
COPPIA PLACCHE S 4FV WC72 PLACCA S WC72 Q6 (coppia) pair of plate S 4FV wc 72	79130088601	79130088603	79130088604	79130088609	10
COPPIA PLACCHE S 4FV WC90 PLACCA S WC90 Q6 (coppia) pair of plate S 4FV wc 90	79130088001	79130088003	79130088004	79130088009	10

# PLACCA X

ALLUMINIO

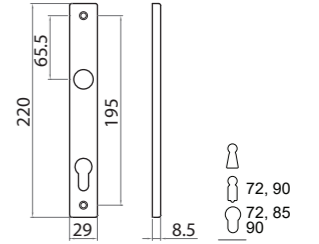

	F1	F3	F4	F9	Conf. Pz.
COPPIA PLACCHE X CH 90 Coppia placche X foro CH 90 pair of plate X hole CH90	79180851001	79180851003	79180851004	79180851009	10
COPPIA PLACCHE X CH 70 Coppia placche X foro CH 70 pair of plate hole CH70	79180857001	79180857003	79180857004	79180857009	10
COPPIA PLACCHE X BB 72 Coppia placche X foro BB 72 pair of plate X hole BB72	79180851601	79180851603	79180851604	79180851609	10
COPPIA PLACCHE X BB 90 Coppia placche X foro BB 90 pair of plate X hole BB90	79180851201	79180851203	79180851204	79180851209	10
COPPIA PLACCHE X YALE 72 Coppia placche X foro Yale 72 pair of plate X hole cyl.72	79180855601	79180855603	79180855604	79180855609	10
COPPIA PLACCHE X YALE 85 Coppia placche X foro Yale 85 pair of plate X hole cyl 85	79180855001	79180855003	79180855004	79180855009	10

# PLACCA FO24

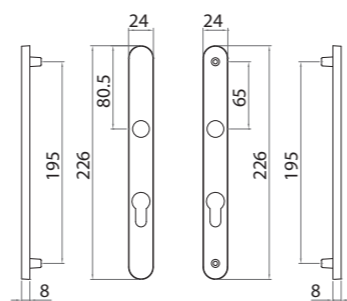

DISPONIBILE A RICHIESTA PER APPLICAZIONI SPECIALI  
AVAILABLE ON REQUEST FOR SPECIAL APPLICATIONS

# PLACCA FO32

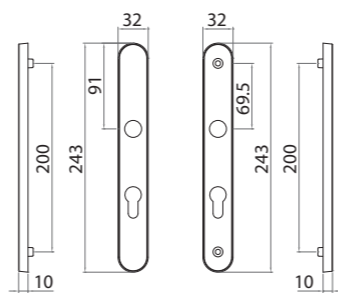

DISPONIBILE A RICHIESTA PER APPLICAZIONI SPECIALI  
AVAILABLE ON REQUEST FOR SPECIAL APPLICATIONS

# PLACCA FO40

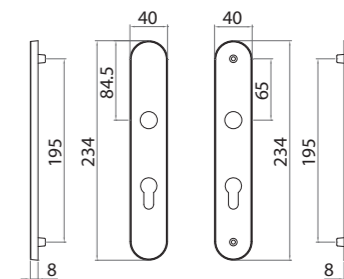

DISPONIBILE A RICHIESTA PER APPLICAZIONI SPECIALI  
AVAILABLE ON REQUEST FOR SPECIAL APPLICATIONS

# PLACCA FR40

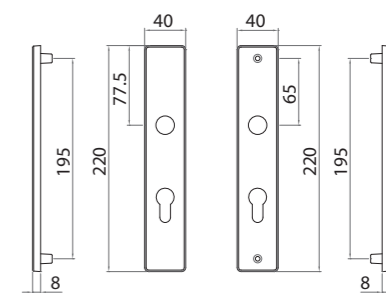

DISPONIBILE A RICHIESTA PER APPLICAZIONI SPECIALI  
AVAILABLE ON REQUEST FOR SPECIAL APPLICATIONS

## GIOCHI DK/DK MECHANISM

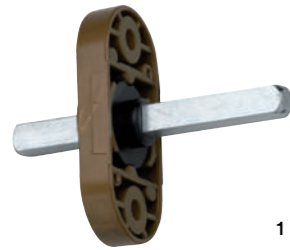

1

	NOR	NAR	Conf. Pz.
GIOCO DK Q7x30 OVALE Gioco DK Q7x30 ovale Window mechanism	18340000114 5,51	18340000115 5,51	10
GIOCO DK Q7x33 OVALE Gioco DK Q7x33 ovale Window mechanism	18340000214 5,51	18340000215 5,51	10
GIOCO DK Q7x40 OVALE Gioco DK Q7x40 ovale Window mechanism	18340000414 5,51	18340000415 5,51	10
GIOCO DK Q7x45 OVALE Gioco DK Q7x45 ovale Window mechanism	18340000514 5,51	18340000515 5,51	10

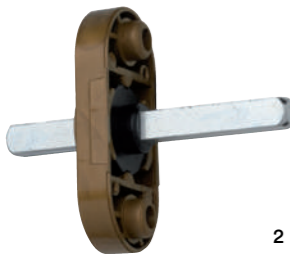

2

GIOCO DK Q7x30 OVALE C/BUSSOLE D.9,5 Gioco DK Q7x30 ovale con bussole D.9,5 Window mechanism	18340100114 5,51	18340100115 5,51	10
GIOCO DK Q7x33 OVALE C/BUSSOLE D.9,5 Gioco DK Q7x33 ovale con bussole D.9,5 Window mechanism	18340100214 5,51	18340100215 5,51	10
GIOCO DK Q7x40 OVALE C/BUSSOLE D.9,5 Gioco DK Q7x40 ovale con bussole D.9,5 Window mechanism	18340100414 5,51	18340100415 5,51	10
GIOCO DK Q7x45 OVALE C/BUSSOLE D.9,5 Gioco DK Q7x45 ovale con bussole D.9,5 Window mechanism	18340100514 5,51	18340100515 5,51	10



4

GIOCO DK NYLON PER MARTELLINE CON FORO Q7 PASSANTE Gioco DK nylon per martelline con foro Q7 passante Window mechanism		18342500011 3,94	10
--	--	---------------------	----

## FERRI/SPINDLES

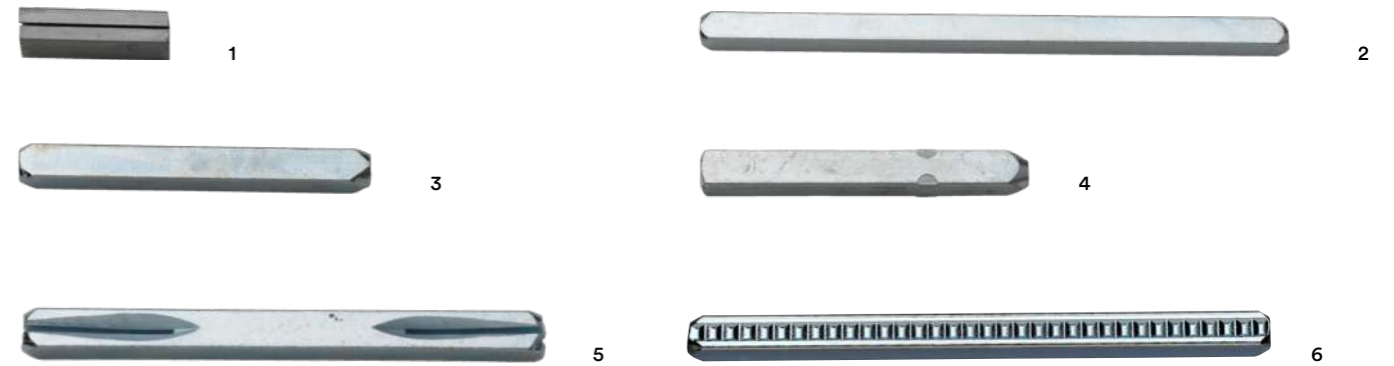

	FE/ZB	Conf. Pz.
Maggiorazione 6x7x20 ferro Adaptor spindle 6 x 7 x 20	13280000011 0,74	
Maggiorazione 6x8x20 ferro Adaptor spindle 6 x 8 x 20	13280100011 0,74	
Maggiorazione 7x8x20 ferro Adaptor spindle 7 x 8 x 20	13280200011 0,74	
FERRO Q6x120 SENZA TAGLI Ferro Q6x120 senza tagli spindle 6mm x 120 without cutting	13210012070 1,41	
FERRO Q7x65 SENZA TAGLI Ferro Q7x65 senza tagli Spindle 7 x 65mm without cutting	13220006570 1,19	
FERRO Q7x70 SENZA TAGLI Ferro Q7x70 senza tagli spindle 7 x 70mm without cutting	13220007070 1,19	
FERRO Q7x75 SENZA TAGLI Ferro Q7x75 senza tagli spindle 7 x 75mm without cutting	13220007570 1,19	
FERRO Q7x59 (DK FISSO SPORG.30) Ferro Q7x59 (DK fisso sporg.30) Spindle DK	13225006170 0,97	
FERRO Q7x62 (DK FISSO SPORG.33) Ferro Q7x62 (DK fisso sporg.33) Spindle DK	13225000170 1,12	
FERRO Q7x64 (DK FISSO SPORG.35-30) Ferro Q7x64 (DK fisso sporg.35-30) Spindle DK	13225006670 1,19	
FERRO Q7x69 (DK FISSO SPORG.40-35) Ferro Q7x69 (DK fisso sporg.40-35) Spindle DK	13225007170 1,26	
Ferro Q8x74 (DK fisso sporg.45-40) special spindle 8 x 74mm for DK	13225007670 1,34	
Ferro Q8x100 2 tagli + fresatura spindle 8 x 100 mm	13230410070 1,64	
Ferro Q8x120 2 tagli + fresatura spindle 8 x 120mm	13230412070 1,64	
Ferro Q8x140 2 tagli + fresatura spindle 8 x 140 mm	13230414070 1,64	
Ferro Q8x160 2 tagli + fresatura spindle 8 x 160 mm	13230416070 1,64	
FERRO Q.8x 100 TK ferro Q.8X100 TK spindle 8 x 100 mm	13233710070 1,64	
FERRO Q.8x 120 TK ferro Q.8X120 TK spindle 8 x120 mm	13233712070 1,64	
FERRO Q.8x 140 TK ferro Q.8X140 TK spindle 8 x 140 mm	13233714070 1,64	
FERRO Q.8x 160 TK ferro Q.8X160 TK spindle 8 x 160 mm	13233716070 1,64	
FERRO Q6x1000 (VERGA) Ferro Q6x1000 (verga) spindle 6mm x 1'000 ( rod )	13175610011 5,36	
FERRO Q7x1000 (VERGA) Ferro Q7x1000 (verga) spindle 7mm x 1000 ( rod )	13175710011 5,36	
FERRO Q8x1000 (VERGA) Ferro Q8x1000 (verga) spindle 8mm x 1000 ( rod )	13175810011 5,36	

# FERRI/SPINDLES



	FE/ZB	Conf. Pz.
Ferro Q8x43 ad espansione special spindle 8 x 43mm	13230500006	3,94
Ferro Q8x55 ad espansione special spindle 8 x 55mm	13230500106	4,17
Ferro Q8x65 ad espansione special spindle 8 x 65mm	13230500206	4,17
Ferro Q8x80 ad espansione special spindle 8 x 80mm	13230500306	4,39
	FE/ZB	Conf. Pz.
Ferro Q8x95 con niplex MB 14 folle spindle 8 x 95mm with niplex M 14 free	13230600070	3,27
Ferro Q8x100 con niplex MB 14 folle spindle 8 x 100mm with niplex MB 14 free	13230600170	3,27
Ferro Q8x105 con niplex MB 14 folle spindle 8 x 105mm with niplex MB 14 free	13230600270	3,27
Ferro Q8x110 con niplex MB 14 folle spindle 8 x 110mm with niplex MB 14 free	13230600370	3,27
Ferro Q8x130 con niplex MB 14 folle spindle 8 x 130mm with niplex MB 14 free	13230600570	3,27
Ferro Q8x115 con niplex MB 14 folle spindle 8 x 115mm with niplex MB 14 free	13230600670	3,27
Ferro Q8x100 con niplex M10 folle spindle 8 x 100mm with niplex M 10 free	13233600170	3,27
Ferro Q8x110 con niplex M10 folle spindle 8 x 110mm with niplex M 10 free	13233600270	3,27
Ferro Q8x95 con niplex M10 folle spindle 8 x 95mm with niplex M 10 free	132336009570	3,27
Ferro Q8x105 con niplex M10 folle spindle 8 x 105mm with niplex M 10 free	13233610570	3,27
Ferro Q8x115 con niplex M10 folle spindle 8 x 115mm with niplex M 10 free	13233611570	3,27
Ferro Q8x120 con niplex M10 folle spindle 8 x 120mm with niplex M 10 free	13233612070	3,27
Ferro Q8x130 con niplex M10 folle spindle 8 x 130mm with niplex m 10 free	13233613070	3,27

# FERRI CON PIASTRINE/SPINDLES WITH PLATELETS



	FOLLE	Conf. Pz.
Ferro Q8x100 con piastrina Q8x30 folle special spindle 8 x 100mm	13230800070	4,39
Ferro Q8x85 con piastrina Q8x30 folle special spindle 8 x 85mm	13230800170	4,39
Ferro Q8x70 con piastrina Q8x30 folle special spindle 8 x 70mm	13230800270	4,39

# PIASTRINE/PLATELETS



	FE/ZB
Piastrina D.32 Q8x25 item for fixing lever handle or knob	13320010270
	3,57
Piastrina D.32 c/vite M8x25 item for fixing lever handle or knob	13320110070
	4,02

# VITI/SCREWS



	FE/ZB	Conf. Pz.
CONF.098* 2VITI TPS+M5X40	19000001770	
	0,37	
CONF.144* 2VITI TPS+M5X45	19000004870	
	0,37	
	TROP	Conf. Pz.
CONF.146* 10VITI TP+3X16	19000005006	
	0,45	
	OTTONATE	Conf. Pz.
CONF.147* 4VITI TGS+3,5X25	19000005101	
	0,52	
CONF.148* 8VITI TGS+3,5X25	19000005201	
	0,60	
	FE/ZB	Conf. Pz.
CONF.149*500 VITI DIN 965	19000005370	
	42,56	
CONF.150*500 VITI DIN 965	19000005470	
	50,44	
CONF.151*500 VITI DIN 965	19000005570	
	65,17	
CONF.152*500 VITI DIN 965	19000005670	
	39,73	
CONF.177* 2VITI TPS+M5X35	19000006770	
	0,37	
CONF.220* 2VITI TPS+ M5x50	19000008570	
	0,45	

# 4

**Coordinati per  
porte scorrevoli**

**Sliding door  
accessories**

350 Alluminio galattico / Galactic aluminum  
352 Zama / Zamak  
360 Ottone / Brass  
361 Alluminio / Aluminum

# SCORRI TONDO CIECO

ALLUMINIO GALATTICO

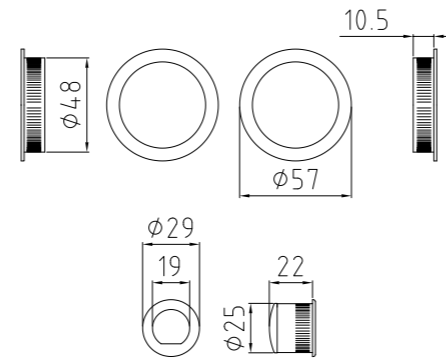

Mont. n°123

	MERCURY	URANUS	JUPITER	SPACE	Conf. Pz.
SCORRI TONDO CIECO	7704871613390	7704871613490	7704871614190	7704871617690	4
Square sliding door	9,46 ⚡	9,46 ⚡	9,46 ⚡	9,46 ⚡	

⚡ Servizio G48: Articolo a magazzino e disponibile entro 48 dall'elaborazione dell'ordine. In base a disponibilita' e condizioni di vendita.  
G48 service: Item in stock and available within 48 hours of order processing. Based on availability and sales conditions.

# SCORRI QT CIECO

ALLUMINIO GALATTICO

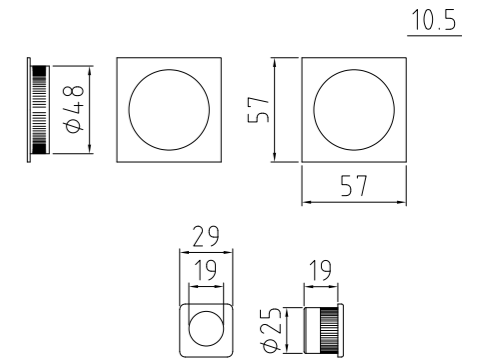

Mont. n°120

	MERCURY	URANUS	JUPITER	SPACE	Conf. Pz.
SCORRI QT CIECO	7704872463390	7704872463490	7704872464190	7704872467690	4
Square sliding door handle	9,46 ⚡	9,46 ⚡	9,46 ⚡	9,46 ⚡	

⚡ Servizio G48: Articolo a magazzino e disponibile entro 48 dall'elaborazione dell'ordine. In base a disponibilita' e condizioni di vendita.  
G48 service: Item in stock and available within 48 hours of order processing. Based on availability and sales conditions.

# SCORRI TONDO BLOCC S/SERRATURA

ALLUMINIO GALATTICO

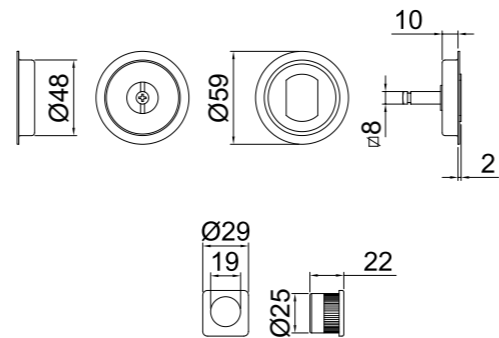

Mont. n°122

	MERCURY	URANUS	JUPITER	SPACE	Conf. Pz.
SCORRI TONDO BLOCC s/serratura	7704871913390	7704871913490	7704871914190	7704871917690	1
Sliding door handle without lock	20,93 ⚡	20,93 ⚡	20,93 ⚡	20,93 ⚡	

⚡ Servizio G48: Articolo a magazzino e disponibile entro 48 dall'elaborazione dell'ordine. In base a disponibilita' e condizioni di vendita.  
G48 service: Item in stock and available within 48 hours of order processing. Based on availability and sales conditions.

# SCORRI QT BLOCC S/SERRATURA

ALLUMINIO GALATTICO

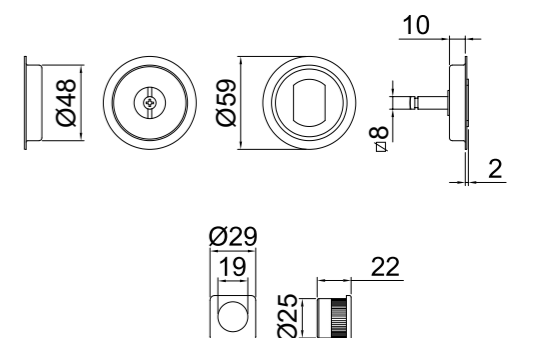

Mont. n°117

	MERCURY	URANUS	JUPITER	SPACE	Conf. Pz.
SCORRI QT BLOCC s/serratura	7704872413390	7704872413490	7704872414190	7704872417690	1
Square sliding door handle without lock	20,93 ⚡	20,93 ⚡	20,93 ⚡	20,93 ⚡	

⚡ Servizio G48: Articolo a magazzino e disponibile entro 48 dall'elaborazione dell'ordine. In base a disponibilita' e condizioni di vendita.  
G48 service: Item in stock and available within 48 hours of order processing. Based on availability and sales conditions.



Per istruzioni di montaggio scansiona QR code, seleziona il numero di riferimento e segui le istruzioni.  
For assembly instructions scan the QR code, select the relevant assembly number and follow the instructions.



Per istruzioni di montaggio scansiona QR code, seleziona il numero di riferimento e segui le istruzioni.  
For assembly instructions scan the QR code, select the relevant assembly number and follow the instructions.



# SCORRI TONDO CIECO

ZAMA

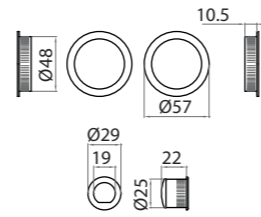

Mont. n°123

	ZCL	ZCS	ZNO	RAL9010	Z-BGO	Conf. Pz.
SCORRI TONDO CIECO	6GM9871600790	6GM9871601390	6GM9871601690	6GM9871606390	6GM9871606490	
sliding door	9,98 ⚡	9,08 ⚡	11,63 ⚡	13,38 ⚡	13,72 ⚡	
	ZBR	ZGV	GCTOL	Z-OLD	Z-OSO	Conf. Pz.
SCORRI TONDO CIECO	6GM9871600090	6GM9871600490	6GM9871601290	6GM9871602890	6GM9871606690	
sliding door	28,29 ⚡	15,23 ⚡	12,00 ⚡	31,43 ⚡	11,62 ⚡	

⚡ Servizio G48: Articolo a magazzino e disponibile entro 48 dall'elaborazione dell'ordine. In base a disponibilita' e condizioni di vendita.  
G48 service: Item in stock and available within 48 hours of order processing. Based on availability and sales conditions.

# SCORRI TONDO PATENT

ZAMA

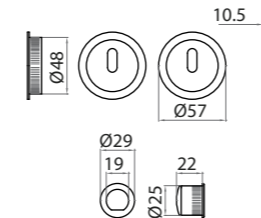
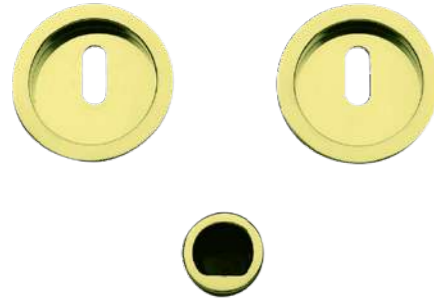

Mont. n°124

	OBR	ZCL	GCTOL	ZCS	Conf. Pz.
SCORRI TONDO PATENT	55748717000	6GM98717007	6GM98717012	6GM98717013	
sliding door	14,88	13,84	10,56	13,84	4



Per istruzioni di montaggio scansiona QR code, seleziona il numero di riferimento e segui le istruzioni.  
For assembly instructions scan the QR code, select the relevant assembly number and follow the instructions.

# KIT SCORRI TONDO BLOCC C/SERR ECO

ZAMA

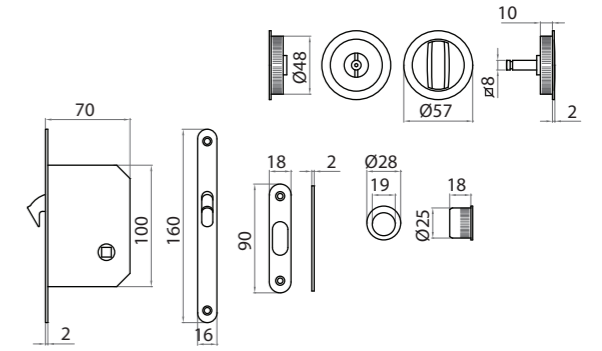
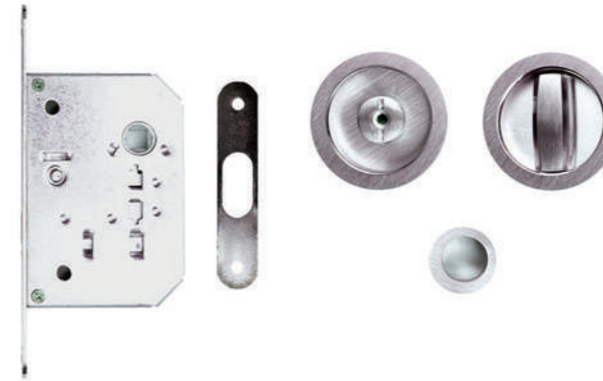

Mont. n°122

ADATTO PER SPESSORE PANNELLO mm 44, ± 1mm

	ZCL	GCTOL	ZCS	Conf. Pz.
KIT SCORRI TONDO BLOCC c/serratura eco	66048718807	66048718812	66048718813	
Sliding door handle with lock	20,46	20,46	13,86	1

# KIT SCORRI TONDO BLOCCO C/SERR

ZAMA

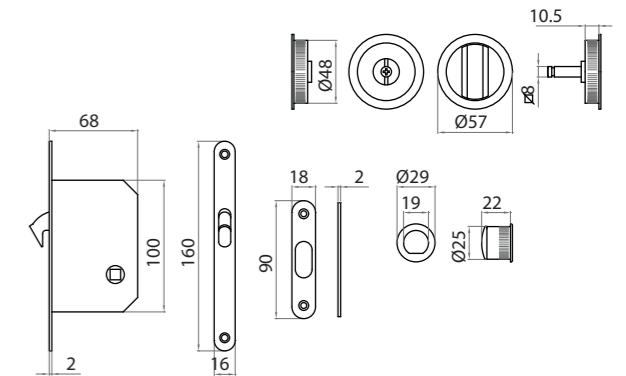

Mont. n°122

ADATTO PER SPESSORE PANNELLO mm 44, ± 1mm

	ZCL	GCTOL	ZCS	ZNO	RAL9010	Conf. Pz.
KIT SCORRI TONDO BLOCC c/serratura	6GM98718807	6GM98718812	6GM98718813	6GM98718816	6GM98718863	
Sliding door handle with lock	35,12	31,25	35,12	44,27		1
	ZGV	Z-OLD	ZBR	Z-BGO	Z-OSO	Conf. Pz.
KIT SCORRI TONDO BLOCC c/serratura	6GM98718804	6GM98718828	6GM98718800	6GM98718864	6GM98718866	
Sliding door handle with lock	43,40					1



Per istruzioni di montaggio scansiona QR code, seleziona il numero di riferimento e segui le istruzioni.  
For assembly instructions scan the QR code, select the relevant assembly number and follow the instructions.

# SCORRI TONDO BLOCC S/SERR

ZAMA

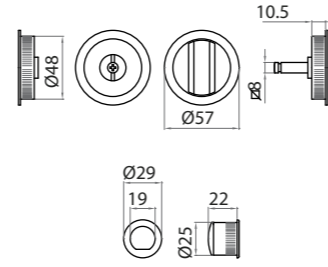

Mont. n°122

ADATTO PER SPESSORE PANNELLO mm 44, ± 1mm

	ZCL	GCTOL	ZCS	ZNO	RAL9010	Conf. Pz.
SCORRI TONDO BLOCC s/serratura	6GM9871800790	6GM9871801290	6GM9871801390	6GM9871801690	6GM9871806390	1
Sliding door handle without lock	17,69	20,98	16,68	19,95	22,43	
	ZBR	ZGV	Z-OLD	Z-BGO	Z-OSO	Conf. Pz.
SCORRI TONDO BLOCC s/serratura	6GM9871800090	6GM9871800490	6GM9871802890	6GM9871806490	6GM9871806690	1
Sliding door handle without lock	45,26	24,83	48,09	22,42	19,94	

⚡ Servizio G48: Articolo a magazzino e disponibile entro 48 dall'elaborazione dell'ordine. In base a disponibilità e condizioni di vendita.  
G48 service: Item in stock and available within 48 hours of order processing. Based on availability and sales conditions.

# KIT SCORRI TONDO PATENT C/SERR

ZAMA

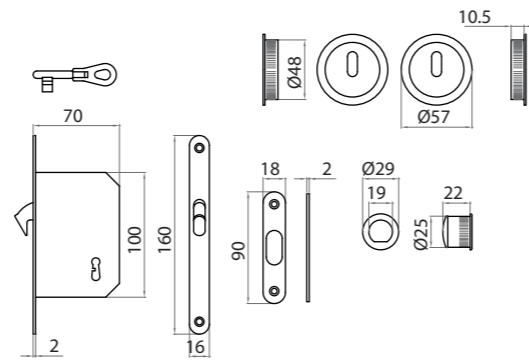
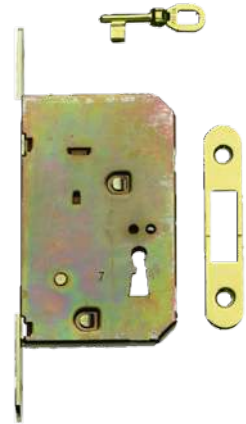

Mont. n°124

	OBR	ZCL	GCTOL	ZCS	Conf. Pz.
KIT SCORRI TONDO PATENT c/serratura	55748717800	6GM98717807	6GM98717812	6GM98717813	1
Sliding door handle key hole with lock	35,12	29,31	25,59	29,31	



Per istruzioni di montaggio scansiona QR code, seleziona il numero di riferimento e segui le istruzioni.  
For assembly instructions scan the QR code, select the relevant assembly number and follow the instructions.

# KIT SCORRI TONDO BLOCC C/SERR PEND

ZAMA

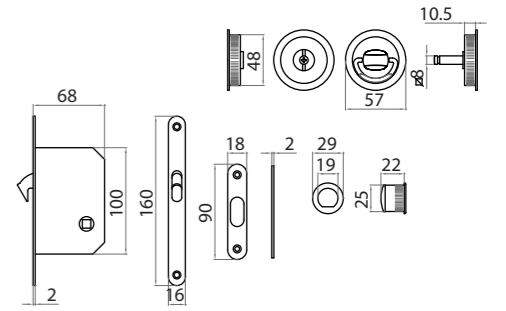
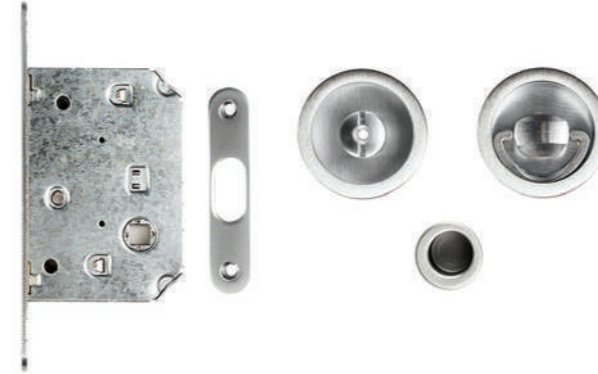

Mont. n°122

	ZCL	GCTOL	ZCS	Conf. Pz.
KIT SCORRI TONDO BLOCC c/serratura pendente	66098718907	66098718912	66098718913	1
Sliding door handle with lock	43,90	39,13	43,90	

# TRASCINATORE TONDO

OTTONE

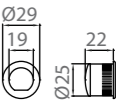
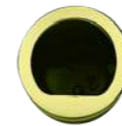

	OBR	OLV	OCS	OCL	Conf. Pz.
TRASCINATORE PORTE SCORR	55748710000	55748710001	55748710003	55748710007	10
round handle for sliding door	4,76	4,76	5,51	5,51	



Per istruzioni di montaggio scansiona QR code, seleziona il numero di riferimento e segui le istruzioni.  
For assembly instructions scan the QR code, select the relevant assembly number and follow the instructions.

## SCORRI Q CIECO

ZAMA

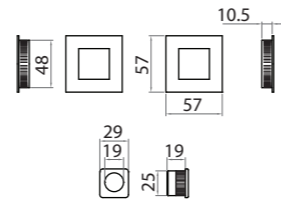

Mont. n°115

	ZCL	ZCS	Conf. Pz.
SCORRI Q CIECO	66148726007	66148726013	4
Square sliding door	15,62	15,62	

## SCORRI Q PATENT

ZAMA

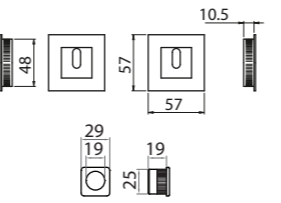
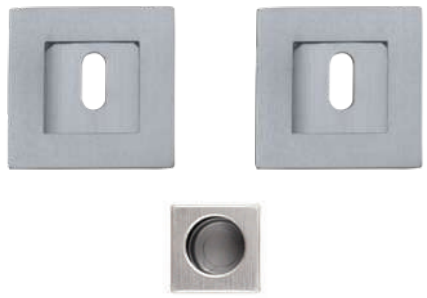

Mont. n°116

	ZCL	ZCS	Conf. Pz.
SCORRI Q PATENT	66148727007	66148727013	4
Square sliding door key hole	15,62	15,62	

## SCORRI Q PATENT C/SERR

ZAMA

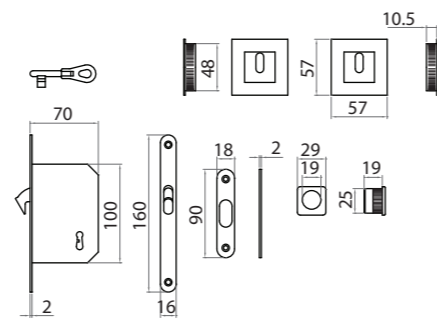
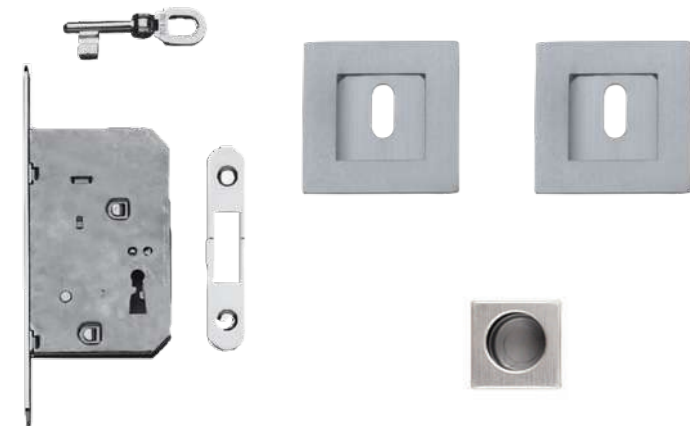

Mont. n°118

	ZCL	ZCS	Conf. Pz.
KIT SCORRI Q PATENT c/serratura	66148727807	66148727813	1
Sliding door handle key hole with lock	31,99	31,99	

## SCORRI QT CIECO

ZAMA

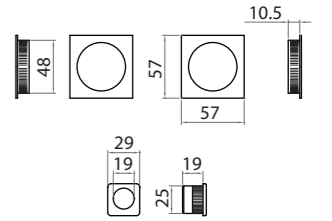
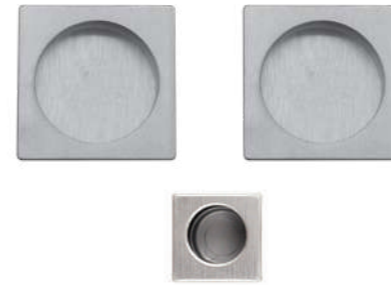

Mont. n°120

	ZCS	ZNO	RAL9010	Z-BGO	Z-OSO	Conf. Pz.
SCORRI QT CIECO	6614872401390	6614872401690	6614872406390	6614872406490	6614872406690	4
Square sliding door	10,33 ⚡	12,80 ⚡	14,40 ⚡	18,12 ⚡	12,79 ⚡	

## SCORRI QT PATENT

ZAMA

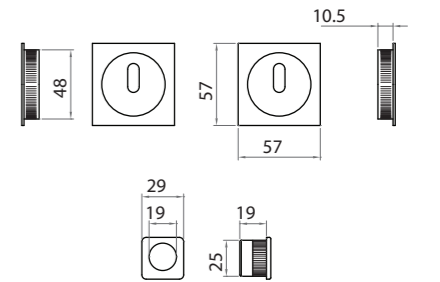
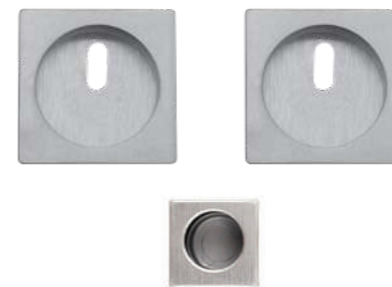

Mont. n°119

	ZCL	ZCS	Conf. Pz.
SCORRI QT PATENT	66148725007	66148725013	4
Square sliding door key door	19,49	19,49	

## KIT SCORRI QT BLOCC SERR. ECO

ZAMA

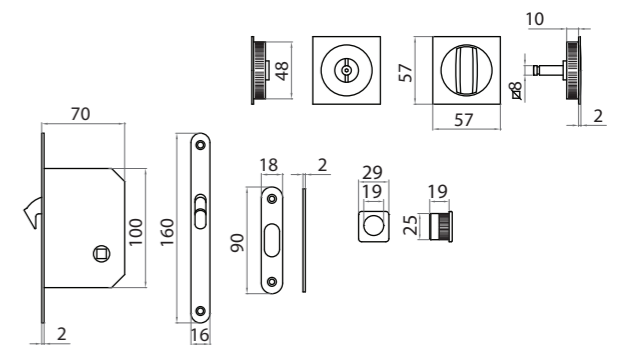
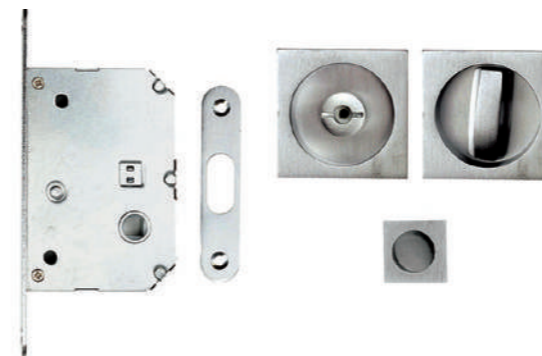

Mont. n°117

	ZCL	GCTOL	ZCS	Conf. Pz.
KIT SCORRI QT BLOCC c/serratura eco	66048724807	66048724812	66048724813	1
Square sliding door handle with lock	25,17	25,17	14,85	

## KIT SCORRI QT BLOCC C/SERR

ZAMA

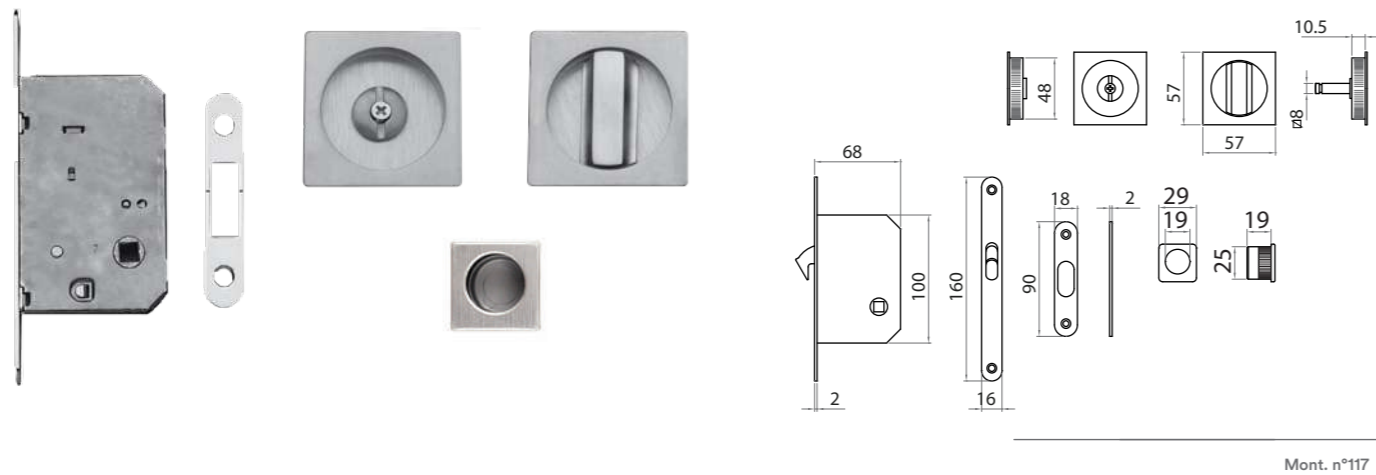

Mont. n°117

	ZCL	ZCS	ZNO	RAL9010	Z-BGO	Z-OSO	Conf. Pz.
KIT SCORRI QT BLOCC c/serratura	66148724807	66148724813	66148724816	66148724863	66148724864	66148724866	1
Square sliding door handle with lock	42,26	38,31	39,99	26,93	39,05	32,30	

## KIT SCORRI QT PATENT C/SERR

ZAMA

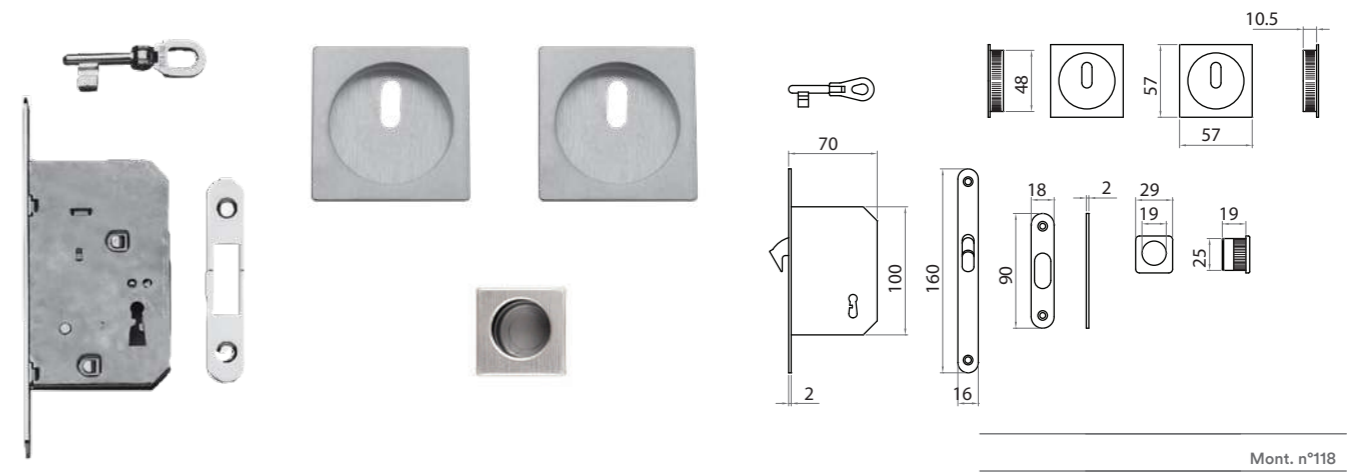

Mont. n°118

	ZCL	ZCS	Conf. Pz.
KIT SCORRI QT PATENT c/serratura	66148725807	66148725813	1
Square sliding door key hole with lock	40,03	40,03	

## SCORRI QT BLOCC S/SERR

ZAMA

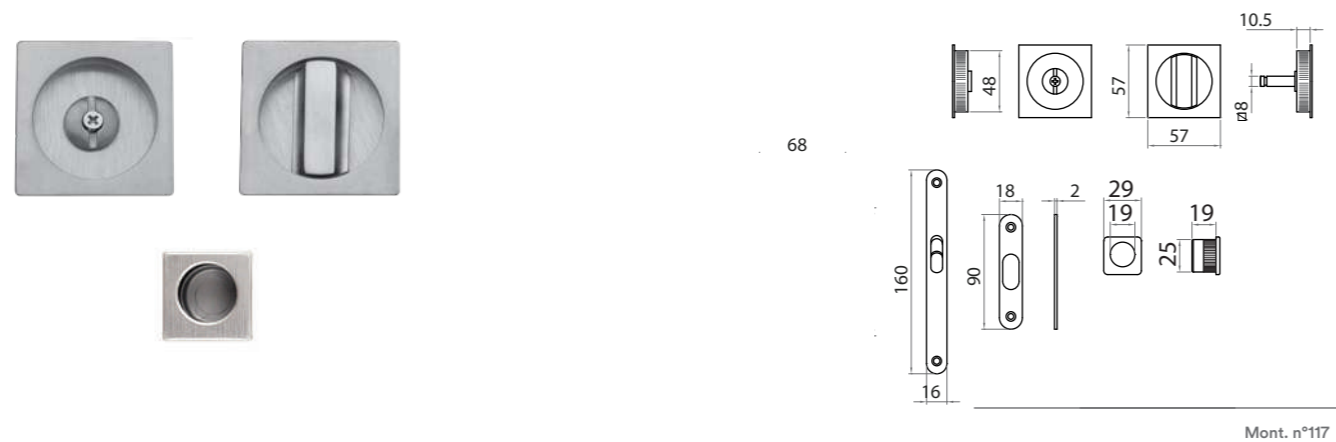

Mont. n°117

	ZCL	ZCS	ZNO	RAL9010	Z-BGO	Z-OSO	Conf. Pz.
SCORRI QT BLOCC s/serratura	6614872420790	6614872421390	6614872421690	6614872426390	6614872426490	6614872426690	1
Square sliding door handle without lock	18,77 ⚡	17,92 ⚡	21,11 ⚡	23,43 ⚡	26,51 ⚡	21,10 ⚡	

⚡ Servizio G48: Articolo a magazzino e disponibile entro 48 dall'elaborazione dell'ordine. In base a disponibilita' e condizioni di vendita.  
G48 service: Item in stock and available within 48 hours of order processing. Based on availability and sales conditions.



Per istruzioni di montaggio scansiona QR code, seleziona il numero di riferimento e segui le istruzioni.  
For assembly instructions scan the QR code, select the relevant assembly number and follow the instructions.

## TRASCINATORE Q

ZAMA

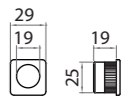

	OLV	OCS	OCL	Conf. Pz.
TRASCINATORE PORTE SCORR	55748710501	55748710503	55748710507	10
square handle for sliding door	4,76	5,51	5,51	

## ELY

OTTONE

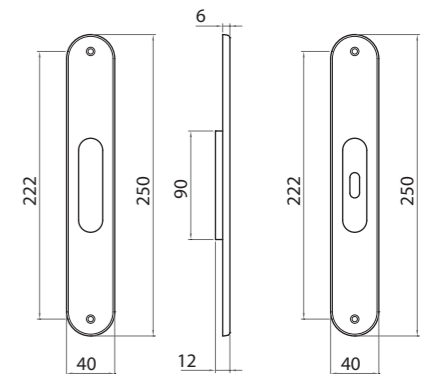

	OLV	OCS	OGV	OCL	OS	Conf. Pz.
PLAC INCAS S/F	55048750001	55048750003	55048750004	55048750007	55048750008	6
sliding door handle blind	16,37	20,39	16,37	20,39	16,37	
PLACC INCAS PAT	55048751001	55048751003	55048751004	55048751007	55048751008	6
sliding door handle key hole	16,37	20,39	16,37	20,39	16,37	

# OVALE COPRIVITI

OTTONE

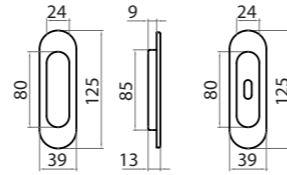
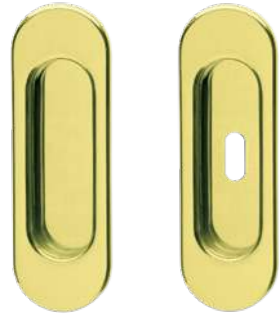

	OLV	OCS	OGV	OCL	OS	Conf. Pz.
INCASSO OVALE COP S/F	55798700001	55798700003	55798700004	55798700007	55798700008	6
sliding door handle	12,20	11,68	12,20	16,37	12,20	
INCASSO OVALE COP PAT	55798701001	55798701003	55798701004	55798701007	55798701008	6
sliding door handle	12,20	16,37	12,20	16,37	12,20	

# GIOIA

OTTONE

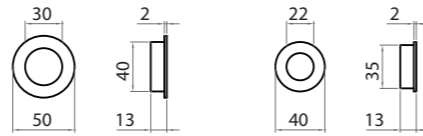

	OLV	OCS	OGV	OCL	OS	Conf. Pz.
INCAS MM 35 TON	55448735001	55448735003	55448735004	55448735007	55448735008	10
Round sliding door mm.35	7,59	8,04	7,59	10,12	7,59	
INCAS MM 40 TON	55448740001	55448740003	55448740004	55448740007	55448740008	10
Round sliding door mm.40	8,63	9,02	8,63	11,31	8,63	

# R95

OTTONE

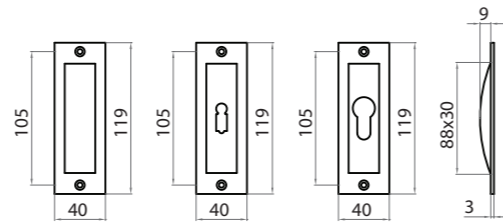

	OCS	OF	OCL	ONS	ONL	Conf. Pz.
NICCHIA CIECA	R009500000003	R009500000006	R009500000007	R009500000027	R009500000030	10
sliding door handle	20,24	18,30	20,24	21,28	20,24	
NICCHIA foro BB	R009600001203	R009600001206	R009600001207	R009600001227	R009600001230	10
sliding door handle key hole	21,28	19,49	21,28	22,47	21,28	
NICCHIA foro YALE	R009600005003	R009600005006	R009600005007	R009600005027	R009600005030	10
sliding door handle cylinder hole	21,28	19,49	21,28	22,47	21,28	

# SCORRI TONDO CIECO

ALLUMINIO

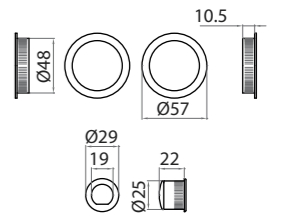

SCORRI TONDO CIECO

Square sliding door

	F1	F4	Conf. Pz.
SCORRI TONDO CIECO	77048716001	77048716004	4
	9,82	9,82	

# SCORRI TONDO PATENT

ALLUMINIO

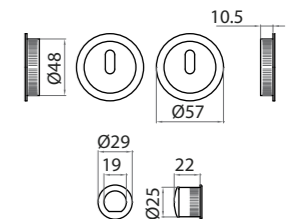
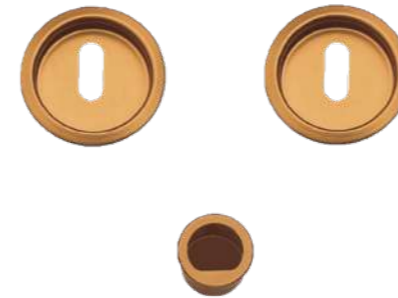

SCORRI TONDO PATENT

Square sliding door key hole

	F1	F4	Conf. Pz.
SCORRI TONDO PATENT	77048717001	77048717004	4
	9,82	9,82	

# SCORRI TONDO BLOCC C/SERR

ALLUMINIO

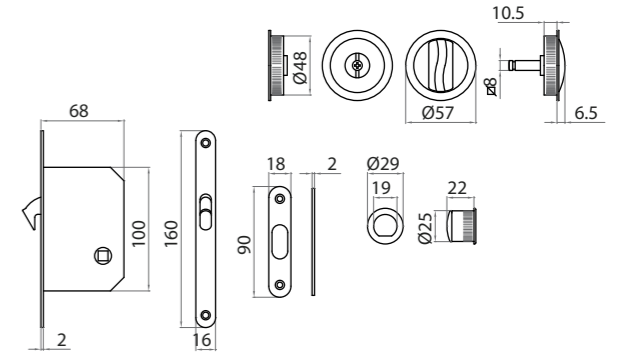
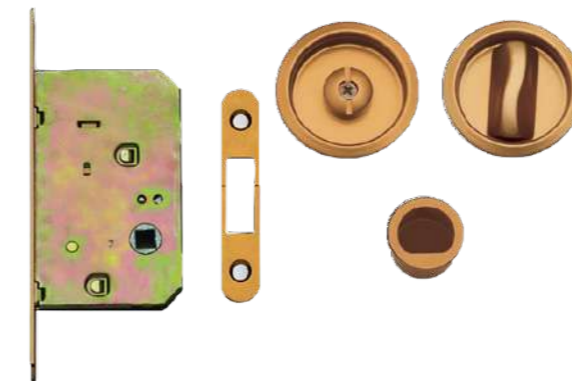

KIT SCORRI TONDO BLOCC c/serratura

Sliding door handle with lock

	F1	F4	Conf. Pz.
KIT SCORRI TONDO BLOCC c/serratura	77048718801	77048718804	1
	37,65	37,65	

# SCORRI TONDO PATENT C/SERR

ALLUMINIO

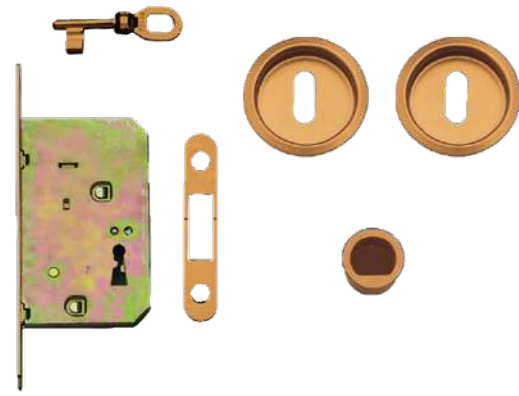

ADATTO PER SPESSORE PANNELLO mm 44, ± 1mm

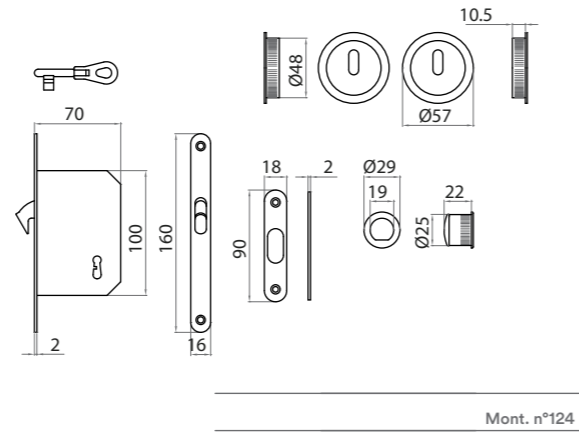

Mont. n°124

KIT SCORRI TONDO PATENT c/serratura

	F1	F4	Conf. Pz.
77048717801	77048717804		1
29,76	29,76		

Sliding door handle key hole with lock

# TRASCINATORE TONDO

ALLUMINIO

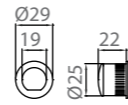

TRASCINATORE PORTE SCORR

	F1	F4	Conf. Pz.
77048710001	77048710004		10
4,02	4,02		

round handle for sliding door

# SCORRI QT CIECO

ALLUMINIO

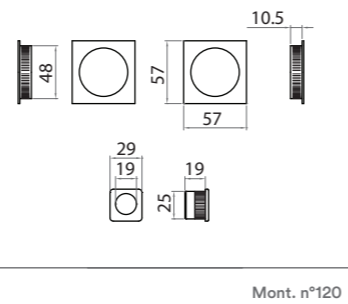
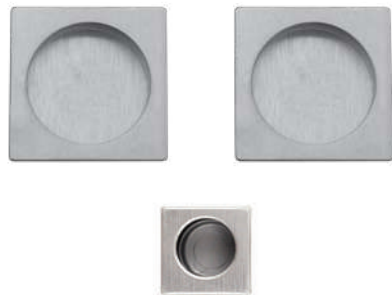

Mont. n°120

SCORRI QT CIECO

	F1	Conf. Pz.
77048724001		4
7,14		

Square sliding door handle

# SCORRI QT PATENT

ALLUMINIO

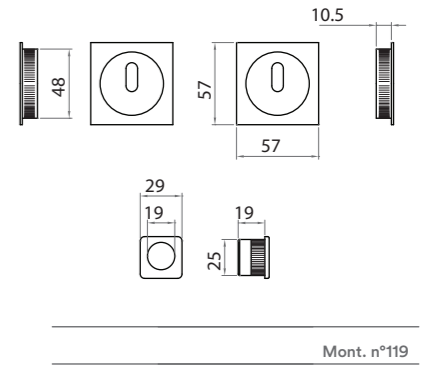
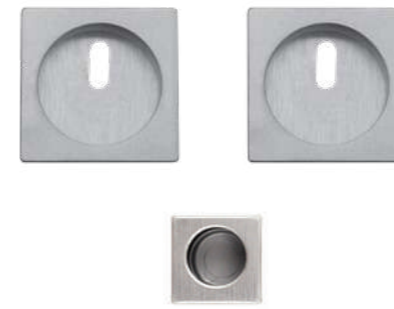

Mont. n°119

SCORRI QT PATENT

	F1	Conf. Pz.
77048725001		4
7,14		

Sliding door handle key hole

# KIT SCORRI QT PATENT C/SERR

ALLUMINIO

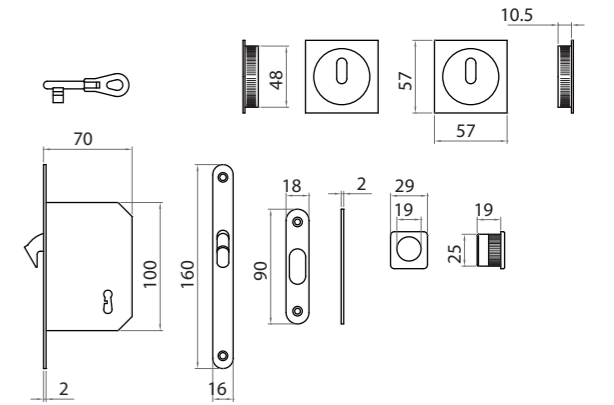

Mont. n°121

KIT SCORRI QT PATENT c/serratura

	F1	Conf. Pz.
77048725801		1
29,16		

Square sliding door key hole with lock

# KIT SCORRI QT BLOCC C/SERR

ALLUMINIO

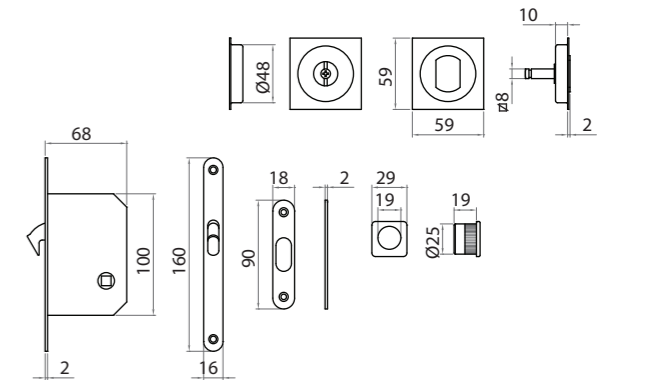
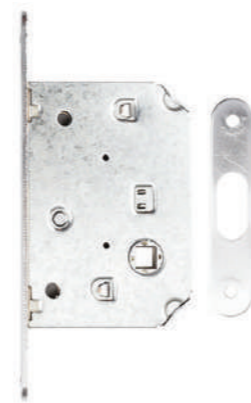

Mont. n°117

ADATTO PER SPESSORE PANNELLO mm 44, ± 1mm

KIT SCORRI QT BLOCC c/serratura

	F1	Conf. Pz.
77048724801		1
32,29		

Square sliding door kit with lock

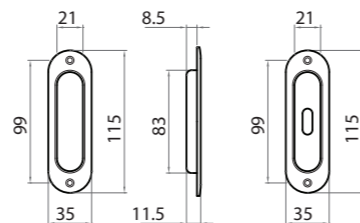
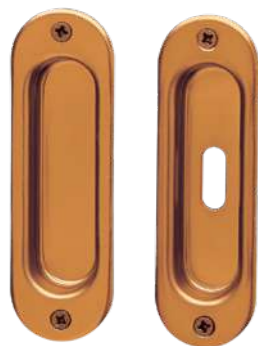

	F1	F4	Conf. Pz.
INCAS S/F	77498700001	77498700004	10
sliding door handle	4,32	4,32	
INCAS PAT	77498701001	77498701004	10
sliding door handle	4,32	4,32	

## KIT SCORRI TONDO BLOCC C-S/SERR. SMART

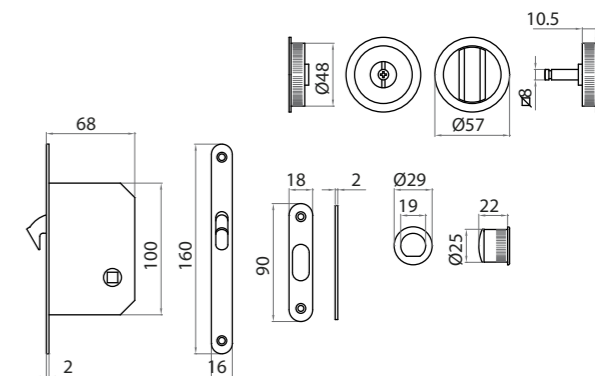

	ZCS/F1-SAT	Conf. Pz.
SCORRI TONDO BLOCC s/serratura SMART	66248714213	1
Sliding door handle without lock	12,17 ⚡	
SCORRI TONDO BLOCC c/serratura SMART	66248714813	1
Sliding door handle with lock	16,92	

⚡ Servizio G48: Articolo a magazzino e disponibile entro 48 dall'elaborazione dell'ordine. In base a disponibilita' e condizioni di vendita.  
G48 service: Item in stock and available within 48 hours of order processing. Based on availability and sales conditions.

## 6009

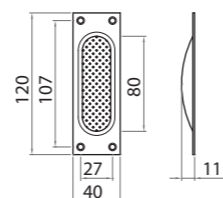

	F1	F4	Conf. Pz.
INCAS S/F	76009700001	76009700004	10
sliding door handle	2,46	2,46	

## KIT SCORRI QT BLOCC C-S/SERR. SMART

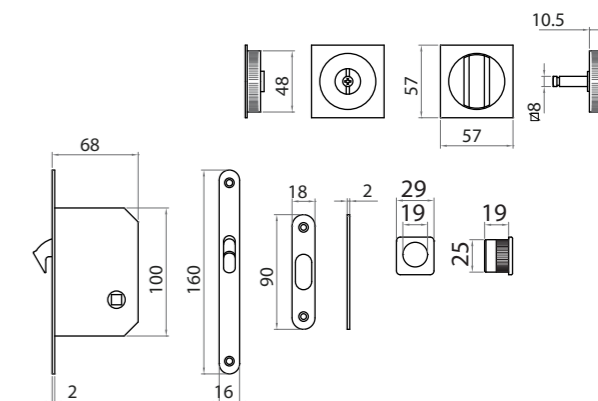

	ZCS/F1-SAT	Conf. Pz.
SCORRI QT BLOCC s/serratura SMART	66248724213	1
Square sliding door without lock	12,17 ⚡	
SCORRI QT BLOCC c/serratura SMART	66248724813	1
Sliding door handle with lock	16,92	

⚡ Servizio G48: Articolo a magazzino e disponibile entro 48 dall'elaborazione dell'ordine. In base a disponibilita' e condizioni di vendita.  
G48 service: Item in stock and available within 48 hours of order processing. Based on availability and sales conditions.



Per istruzioni di montaggio scansiona QR code, seleziona il numero di riferimento e segui le istruzioni.  
For assembly instructions scan the QR code, select the relevant assembly number and follow the instructions.

# 5

**Alluminio galattico**

**Galactic Aluminum**

368 Maniglie + dk / Handles + dk  
374 Maniglioni per alzanti scorrevoli / Pull handles for sliding door  
375 Maniglie per porte scorrevoli / Sliding door handles  
377 Maniglioni fissi / Pull handles



# 7900

Codice Maniglia

7900

Galactic Aluminium

Handles



MERCURY

	MERCURY	URANUS	JUPITER	SPACE	Conf. Pz.
1 Q8 RBQ 50x4 C/M Guarnitura Q8 ros./bocc. QUADRA patent con molla Lever handle 8mm on square rose key hole escutcheon springloaded	77900241833 32,48 ⚡	77900241834 32,48 ⚡	77900241841 32,48 ⚡	77900241876 32,48 ⚡	10
1 Q8 RBQY 50x4 C/M Guarnitura Q8 ros./bocc. QUADRA Yale con molla Lever handle 8mm on square rose cyl hole escutcheon springloaded	77900245833 32,48 ⚡	77900245834 32,48 ⚡	77900245841 32,48 ⚡	77900245876 32,48 ⚡	10
1 Q8 RBQWC Q6 50x4 C/M Guarnitura Q8 ros./bocc. QUADRA Wc Q6 con molla Lever handle 8mm on square rose wc hole escutcheon 6mm springloaded	77900248833 42,48 ⚡	77900248834 42,48 ⚡	77900248841 42,48 ⚡	77900248876 42,48 ⚡	10
2 DK40 BUS, 9,5 7900 GHTEK DK40 BUS. 9,5 window handle DK x 40mm with pins D.9,5	77900583033 15,25 ⚡	77900583034 15,25 ⚡	77900583041 15,25 ⚡	77900583076 15,25 ⚡	20
2 DK45 BUS, 9,5 c/viti 7900 GHTEK DK45 BUS. 9,5 c/viti window handle DK x 45mm with pins D.9,5 and screws	7790058333391 15,50 ⚡	7790058333491 15,50 ⚡	7790058334191 15,50 ⚡	7790058337691 15,50 ⚡	20

⚡ Servizio G48: Articolo a magazzino e disponibile entro 48 dall'elaborazione dell'ordine. In base a disponibilita' e condizioni di vendita.  
 G48 service: Item in stock and available within 48 hours of order processing. Based on availability and sales conditions.

### PORTA

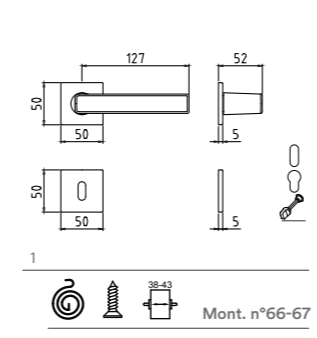

1  
Mont. n°66-67

### FINESTRA

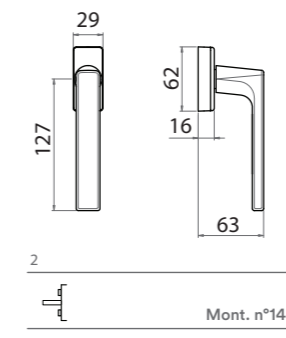

2  
Mont. n°14



Per istruzioni di montaggio  
 scansiona QR code,  
 seleziona il numero di  
 riferimento e segui le  
 istruzioni.  
 For assembly instructions  
 scan the QR code, select the  
 relevant assembly number  
 and follow the instructions.

Codice Maniglia

7900

Alluminio galattico

Maniglie



MERCURY



SPACE



URANUS



JUPITER



URANUS

	MERCURY	URANUS	JUPITER	SPACE	Conf. Pz.
1 Q8 RBQ 50x4 C/M Guarnitura Q8 ros./bocc. QUADRA patent con molla Lever handle 8mm on square rose key hole escutcheon springloaded	70141241733	70141241734	70141241741	70141241776	1
1 Q8 RBQY 50x4 C/M Guarnitura Q8 ros./bocc. QUADRA Yale con molla Lever handle 8mm on square rose cyl hole escutcheon springloaded	70141245733	70141245734	70141245741	70141245776	1
1 Q8 RBQWC Q6 50x4 C/M Guarnitura Q8 ros./bocc. QUADRA Wc Q6 con molla Lever handle 8mm on square rose wc hole escutcheon 6mm springloaded	70141248733	70141248734	70141248741	70141248776	1
2 DK x 40 C/BUSS D.9,5 141 DKx40 C/BUSS D.9,5 window handle DK x 40 mm with pins D.9,5	7014155803395	7014155803495	7014155804195	7014155807695	2
2 DK x 45 C/BUSS D.9,5 C/viti 141 DKx45 C/BUSS D.9,5 C/viti window handle DK x 45 mm with pins D.9,5 with screws	7014155843395	7014155843495	7014155844195	7014155847695	2

⚡ Servizio G48: Articolo a magazzino e disponibile entro 48 dall'elaborazione dell'ordine. In base a disponibilita' e condizioni di vendita.  
G48 service: Item in stock and available within 48 hours of order processing. Based on availability and sales conditions.

## PORTA

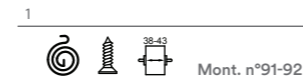
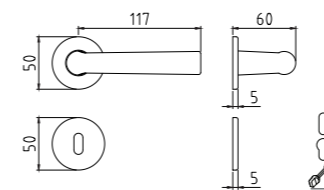

## FINESTRA

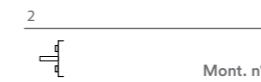
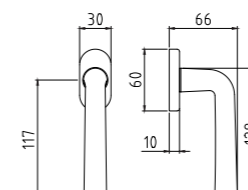

Per istruzioni di montaggio  
scansiona QR code,  
seleziona il numero di  
riferimento e segui le  
istruzioni.  
For assembly instructions  
scan the QR code, select the  
relevant assembly number  
and follow the instructions.

## 7900



FINESTRA

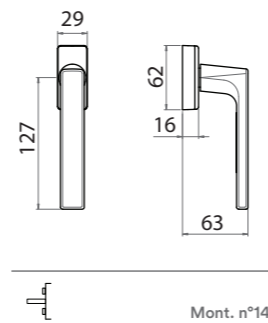

	MERCURY	URANUS	JUPITER	SPACE	Conf. Pz.
DK40 BUS, 9,5	77900583033	77900583034	77900583041	77900583076	20
7900 GHTEK DK40 BUS, 9,5 window handle DK x 40mm with pins D.9,5	15,25	15,25	15,25	15,25	
DK45 BUS, 9,5 c/viti	7790058333391	7790058333491	7790058334191	7790058337691	20
7900 GHTEK DK45 BUS, 9,5 c/viti window handle DK x 45mm with pins D.9,5 and screws	15,50 ⚡	15,50 ⚡	15,50 ⚡	15,50 ⚡	

⚡ Servizio G48: Articolo a magazzino e disponibile entro 48 dall'elaborazione dell'ordine. In base a disponibilita' e condizioni di vendita.  
G48 service: Item in stock and available within 48 hours of order processing. Based on availability and sales conditions.



Per istruzioni di montaggio scansiona QR code, seleziona il numero di riferimento e segui le istruzioni.  
For assembly instructions scan the QR code, select the relevant assembly number and follow the instructions.

## 141



FINESTRA

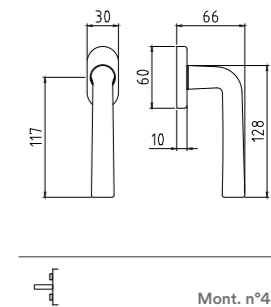

	MERCURY	URANUS	JUPITER	SPACE	Conf. Pz.
DK x 40 C/BUSS D.9,5	7014155803395	7014155803495	7014155804195	7014155807695	2
141 DKx40 C/BUSS D.9,5 window handle DK x 40 mm with pins D.9,5	14,35	14,35	14,35	14,35	
DK x 45 C/BUSS D.9,5 C/viti	7014155843395	7014155843495	7014155844195	7014155847695	2
141 DKx45 C/BUSS D.9,5 C/viti window handle DK x 45 mm with pins D.9,5 with screws	14,65	14,65	14,65	14,65	



Per istruzioni di montaggio scansiona QR code, seleziona il numero di riferimento e segui le istruzioni.  
For assembly instructions scan the QR code, select the relevant assembly number and follow the instructions.

## 7900

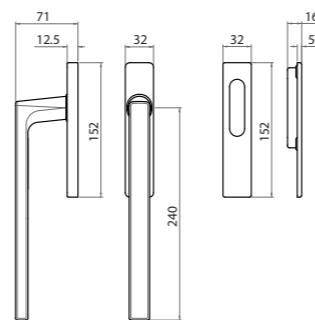

	MERCURY	URANUS	JUPITER	SPACE	Conf. Pz.
SCATTO MAN PC CONCH.	77900601033	77900601034	77900601041	77900601076	1
Maniglione a scatto placca chiusa con conchiglia	62,00 ⚡	62,00 ⚡	62,00 ⚡	62,00 ⚡	
Pull handle for sliding door - closed plate					

⚡ Servizio G48: Articolo a magazzino e disponibile entro 48 dall'elaborazione dell'ordine. In base a disponibilita' e condizioni di vendita.  
G48 service: Item in stock and available within 48 hours of order processing. Based on availability and sales conditions.

## SCORRI TONDO CIECO

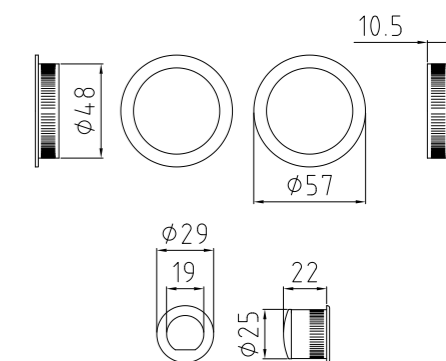

Mont. n°123

	MERCURY	URANUS	JUPITER	SPACE	Conf. Pz.
SCORRI TONDO CIECO	7704871613390	7704871613490	7704871614190	7704871617690	4
Square sliding door	9,46 ⚡	9,46 ⚡	9,46 ⚡	9,46 ⚡	

⚡ Servizio G48: Articolo a magazzino e disponibile entro 48 dall'elaborazione dell'ordine. In base a disponibilita' e condizioni di vendita.  
G48 service: Item in stock and available within 48 hours of order processing. Based on availability and sales conditions.

## SCORRI TONDO BLOCC S/SERRATURA

ALLUMINIO GALATTICO

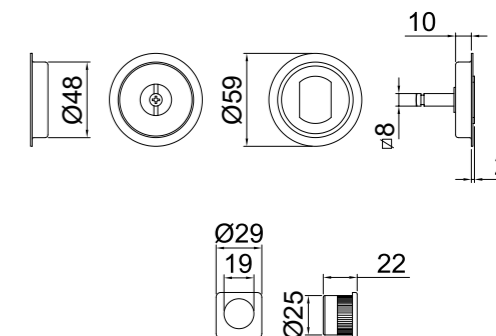

Mont. n°122

	MERCURY	URANUS	JUPITER	SPACE	Conf. Pz.
SCORRI TONDO BLOCC s/serratura	7704871913390	7704871913490	7704871914190	7704871917690	1
Sliding door handle without lock	20,93 ⚡	20,93 ⚡	20,93 ⚡	20,93 ⚡	

⚡ Servizio G48: Articolo a magazzino e disponibile entro 48 dall'elaborazione dell'ordine. In base a disponibilita' e condizioni di vendita.  
G48 service: Item in stock and available within 48 hours of order processing. Based on availability and sales conditions.



Per istruzioni di montaggio scansiona QR code, seleziona il numero di riferimento e segui le istruzioni.  
For assembly instructions scan the QR code, select the relevant assembly number and follow the instructions.

## SCORRI QT CIECO

ALLUMINIO GALATTICO

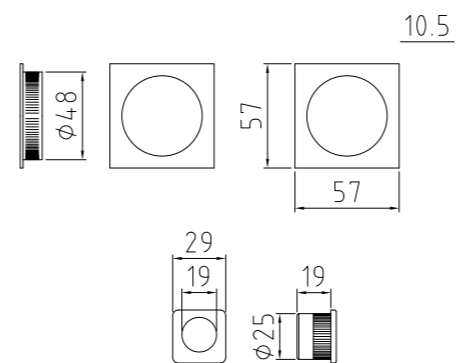

Mont. n°120

	MERCURY	URANUS	JUPITER	SPACE	Conf. Pz.
SCORRI QT CIECO	7704872463390	7704872463490	7704872464190	7704872467690	4
Square sliding door handle	9,46 ⚡	9,46 ⚡	9,46 ⚡	9,46 ⚡	

⚡ Servizio G48: Articolo a magazzino e disponibile entro 48 dall'elaborazione dell'ordine. In base a disponibilita' e condizioni di vendita.  
G48 service: Item in stock and available within 48 hours of order processing. Based on availability and sales conditions.

## EUCLIDE

ALLUMINIO GALATTICO

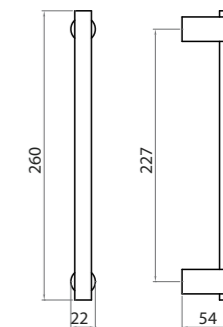

	MERCURY	URANUS	JUPITER	SPACE	Conf. Pz.
MAN DIR	77056600233	77056600234	77056600241	77056600276	1
Maniglione diritto Straight pull handle	40,25 ⚡	40,25 ⚡	40,25 ⚡	40,25 ⚡	

⚡ Servizio G48: Articolo a magazzino e disponibile entro 48 dall'elaborazione dell'ordine. In base a disponibilita' e condizioni di vendita.  
G48 service: Item in stock and available within 48 hours of order processing. Based on availability and sales conditions.

## SCORRI QT BLOCC S/SERRATURA

ALLUMINIO GALATTICO

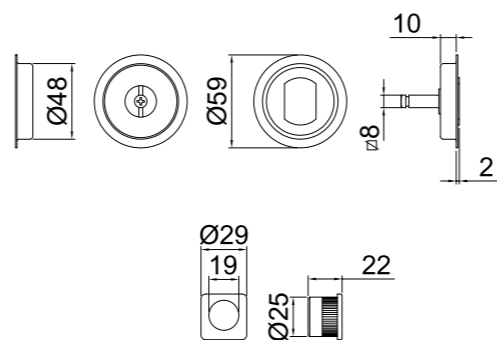
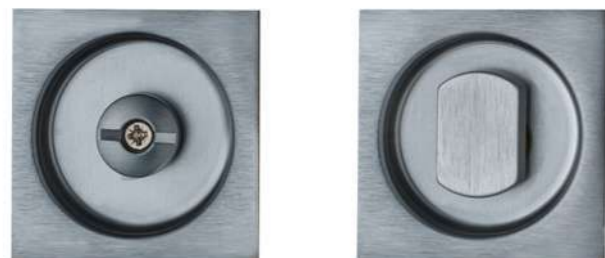

Mont. n°117

	MERCURY	URANUS	JUPITER	SPACE	Conf. Pz.
SCORRI QT BLOCC s/serratura	7704872413390	7704872413490	7704872414190	7704872417690	1
Square sliding door handle without lock	20,93 ⚡	20,93 ⚡	20,93 ⚡	20,93 ⚡	

⚡ Servizio G48: Articolo a magazzino e disponibile entro 48 dall'elaborazione dell'ordine. In base a disponibilita' e condizioni di vendita.  
G48 service: Item in stock and available within 48 hours of order processing. Based on availability and sales conditions.



Per istruzioni di montaggio scansiona QR code, seleziona il numero di riferimento e segui le istruzioni.  
For assembly instructions scan the QR code, select the relevant assembly number and follow the instructions.

## 7900

ALLUMINIO GALATTICO

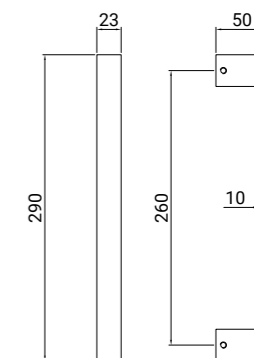

	MERCURY	URANUS	JUPITER	SPACE	Conf. Pz.
MAN DIR	77900600233	77900600234	77900600241	77900600276	1
Maniglione diritto Straight pull handle	44,56 ⚡	44,56 ⚡	44,56 ⚡	44,56 ⚡	

# 6

**Articoli smart**

**Smart products**

380 Maniglie + dk / Handles + dk  
403 Maniglie per porte scorrevoli / Sliding door handles

# GM05

ZAMA



	ZCS	ZCS/F1-SAT	ZCS/F1-SAT/GSH	GCTOL	GCTOL/GSH	ZCL	ZGV	Conf. Pz.
1 Q8 R Guarnitura Q8 ros. senza bocc. Lever handle 8mm on rose		6GM59280013 14,57		6GM58280012 22,10		6GM58280007 28,10	6GM58280004 27,00	1
1 Q8 RB Guarnitura Q8 ros./bocc. patent Lever handle 8mm on rose key hole escutcheon		6GM59281013 16,29 ⚡	6GM59281013S 15,90	6GM58281012 24,00 ⚡	6GM58281012S 17,09	6GM58281007 31,50	6GM58281004 30,10	1
1 Q8 RBY Guarnitura Q8 ros./bocc. yale Lever handle 8mm on rose - cyl. hole escutcheon		6GM59285013 16,29 ⚡	6GM59285013S 15,90	6GM58285012 24,00 ⚡	6GM58285012S 17,09	6GM58285007 31,50	6GM58285004 30,10	1
1 Q8 RBWC Guarnitura Q8 ros./bocc. Wc Lever handle 8mm on rose wc hole escutcheon		6GM59288013 27,71 ⚡		6GM58288012 37,42 ⚡		6GM58288007 44,92	6GM58288004 43,22	1
2 Q8 ROC Guarnitura Q8 ros.ovale senza bocc. Lever handle 8mm on oval rose		6GM58220513 35,69		6GM58220512 37,69		6GM58220507 43,69	6GM58220504 42,59	1
2 Q8 RBOC Guarnitura Q8 ros/boc. ovale patent Lever handle 8mm on oval rose key hole escutcheon		6GM58221513 45,76		6GM58221512 48,26		6GM58221507 55,76	6GM58221504 54,36	1
2 Q8 RBOYC Guarnitura Q8 ros/boc. ovale Yale Lever handle 8mm on oval rose - cyl. hole escutcheon		6GM58225513 45,76		6GM58225512 48,26		6GM58225507 55,76	6GM58225504 54,36	1
3 DK X 40 Martellina DK Q7 x 40 window handle DK x 40 mm		6GM58557013 13,08		6GM58557012 14,33		6GM58557007 18,08	6GM58557004 17,38	2
3 DK X 40 C/BUSS. Martellina DK Q7 x 40 con bussola D. 9,5 window handle DK x 40mm with pins D.9,5		6GM58558013 9,50		6GM58558012 10,75		6GM58558007 14,50	6GM58558004 13,80	2

⚡ Servizio G48: Articolo a magazzino e disponibile entro 48 dall'elaborazione dell'ordine. In base a disponibilita' e condizioni di vendita.  
G48 service: Item in stock and available within 48 hours of order processing. Based on availability and sales conditions.

PORTA

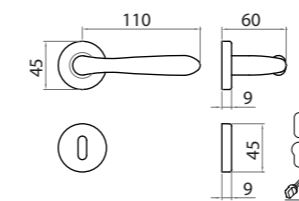

1 Ros 45x9  
Mont. n°88-89

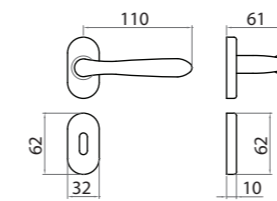

2  
Mont. n°25

FINESTRA

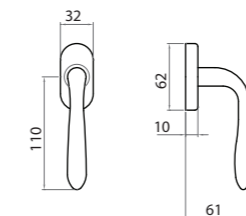

3  
Mont. n°8



Per istruzioni di montaggio scansiona QR code, seleziona il numero di riferimento e segui le istruzioni.  
For assembly instructions scan the QR code, select the relevant assembly number and follow the instructions.

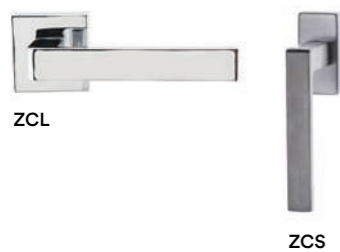

	ZCS	ZCS/F1-SAT	ZCS/GSH	ZCL	Conf. Pz.
1 Q8 RQ Guarnitura Q8 ros. senza bocc. Lever handle 8mm on rose		6GM08240313		6GM08240007	1
		19,97		32,40	
1 Q8 RBQ Guarnitura Q8 ros./bocc. patent Lever handle 8mm on rose key hole escutcheon		6GM08241313	6GM08241013S	6GM08241007	1
		21,57 ⚡	24,00	34,00	
1 Q8 RBQY Guarnitura Q8 ros./bocc. yale Lever handle 8mm on rose - cyl. hole escutcheon		6GM08245313	6GM08245013S	6GM08245007	1
		21,57 ⚡	24,00	34,00	
1 Q8 RBQWC Guarnitura Q8 ros./bocc. Wc Lever handle 8mm on rose wc hole escutcheon		6GM08248313	6GM08248013S	6GM08248007	1
		31,57 ⚡	35,43	46,00	
2 Q8 RRC guarnitura rosetta rettangolare Q8 C/M molla dx/sx Lever handle 8mm on springloaded rectangular rose	6GM08210413			6GM08210407	1
		31,87		39,87	
2 Q8 RBR Guarnitura Q8 ros./bocc. rett. patent molla dx/sx Lever handle 8mm on springloaded rect rose key hole esc	6GM08211413			6GM08211407	1
		36,33		46,33	
2 Q8 RBYR Guarnitura Q8 ros./bocc. rett.yale molla dx/sx Lever handle 8mm on springloaded rect rose - cyl. hole esc	6GM08215413			6GM08215407	1
		36,33		46,33	
3 DK X 40 Martellina DK Q7 x 40 window handle DK x 40 mm	6GM08555013			6GM08555007	2
		20,96		25,96	
3 DK X 40 C/BUSS. Martellina DK Q7 x 40 con bussole D. 9,5 window handle DK x 40mm with pins D.9.5	6GM08556013			6GM08556007	2
		15,14		20,14	

⚡ Servizio G48: Articolo a magazzino e disponibile entro 48 dall'elaborazione dell'ordine. In base a disponibilita' e condizioni di vendita.  
G48 service: Item in stock and available within 48 hours of order processing. Based on availability and sales conditions.

## PORTA

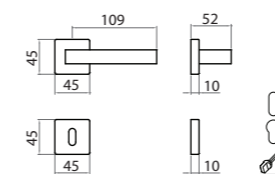

1 Ros 45x45

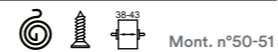

## FINESTRA

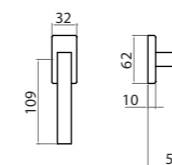

3

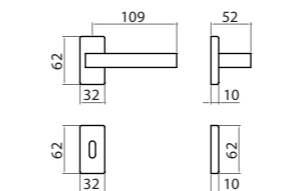

2

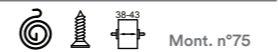

Per istruzioni di montaggio  
scansiona QR code,  
seleziona il numero di  
riferimento e segui le  
istruzioni.  
For assembly instructions  
scan the QR code, select the  
relevant assembly number  
and follow the instructions.





	ZCS	ZCS-MET	ZCS-GSH	ZCL	ZNO	Conf. Pz.
1 Q8 RQ Guarnitura Q8 ros. senza bocc. Lever handle 8mm on rose		6GM11240313 27,97		6GM11240507 35,97	6GM11240516 26,17	1
1 Q8 RBQ Guarnitura Q8 ros./bocc. patent Lever handle 8mm on rose key hole escutcheon		6GM11241313 31,13	6GM11241513S 21,89	6GM11241507 41,13	6GM11241516 28,88	1
1 Q8 RBQY Guarnitura Q8 ros./bocc. yale Lever handle 8mm on rose - cyl. hole escutcheon		6GM11245313 31,13	6GM11245513S 21,89	6GM11245507 41,13	6GM11245516 28,88	1
1 Q8 RBQWC Guarnitura Q8 ros./bocc. Wc Lever handle 8mm on rose wc hole escutcheon		6GM11248313 41,13	6GM11248013S 33,31	6GM11248007 53,13		1
2 Q8 RBR Guarnitura Q8 ros./bocc. rett. patent molla dx/sx Lever handle 8mm on springloaded rect rose key hole esc	6GM11211413 48,48			6GM11211407 58,48		1
2 Q8 RBYS Guarnitura Q8 ros./bocc. rett.yale molla dx/sx Lever handle 8mm on springloaded rect rose - cyl. hole esc	6GM11215413 48,48			6GM11215407 58,48		1
3 DK X 40 C/BUSS. Martellina DK Q7 x 40 con bussole D. 9,5 window handle DK x 40mm with pins D.9,5	6GM11553813 15,28			6GM11553807 20,28		2

⚡ Servizio G48: Articolo a magazzino e disponibile entro 48 dall'elaborazione dell'ordine. In base a disponibilita' e condizioni di vendita.  
G48 service: Item in stock and available within 48 hours of order processing. Based on availability and sales conditions.

## PORTA

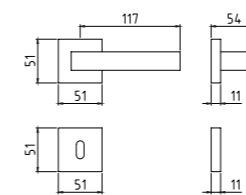

1 Ros 50x50x4



Mont. n°57-58

## FINESTRA

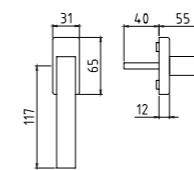

3 - - - -



Mont. n°6

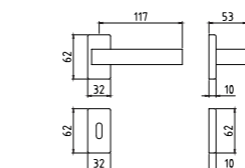

2 0006



Mont. n°75



Per istruzioni di montaggio  
scansiona QR code,  
seleziona il numero di  
riferimento e segui le  
istruzioni.  
For assembly instructions  
scan the QR code, select the  
relevant assembly number  
and follow the instructions.



ZCL



ZCS

# MILENA Z

ZAMA



ZCL



ZCS



GCTOL



GCTOL

	ZCS	ZCS/F1-SAT	GCTOL	ZCL	Conf. Pz.
1 Q8 P90 Guarnitura Q8 placca patent 90 Lever handle 8mm on key plate 90	66744089013 45,28		66744089012 49,03	66744089007 60,28	1
1 Q8 P70 Guarnitura Q8 placca patent 70 Lever handle 8mm on key plate 70	66744087013 45,28		66744087012 49,03	66744087007 60,28	1
1 Q8 PY85 Guarnitura Q8 placca yale 85 Lever handle 8mm on cyl. plate 85	66744088513 45,28		66744088512 49,03	66744088507 60,28	1
2 Q8 R Guarnitura Q8 ros. senza bocc. Lever handle 8mm on rose	66744280513 19,27	66746280513 15,40	66744280512 21,27	66744280507 27,27	1
2 Q8 RB Guarnitura Q8 ros./bocc. patent Lever handle 8mm on rose key hole escutcheon	66744281513 24,60 ⚡	66746281513 18,77	66744281512 27,10 ⚡	66744281507 34,60	1
2 Q8 RBY Guarnitura Q8 ros./bocc. yale Lever handle 8mm on rose - cyl. hole escutcheon	66744285513 24,60 ⚡	66746285513 18,77	66744285512 27,10 ⚡	66744285507 34,60	1
2 Q8 RBWC Guarnitura Q8 ros./bocc. Wc Lever handle 8mm on rose wc hole escutcheon	66744288013 36,03 ⚡	66746288513 30,20	66744288012 40,53 ⚡	66744288007 46,60	1
3 DK X 40 Martellina DK Q7 x 40 window handle DK x 40 mm	66744557013 12,45		66744557012 13,69	66744557007 17,44	2
3 DK X 40 C/BUSS. Martellina DK Q7 x 40 con bussole D. 9,5 window handle DK x 40mm with pins D.9.5	66744558013 12,45		66744558012 13,69	66744558007 17,44	2

⚡ Servizio G48: Articolo a magazzino e disponibile entro 48 dall'elaborazione dell'ordine. In base a disponibilita' e condizioni di vendita.  
G48 service: Item in stock and available within 48 hours of order processing. Based on availability and sales conditions.

## PORTA

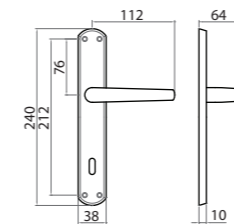

1 Placca MILENA  
 Mont. n°38

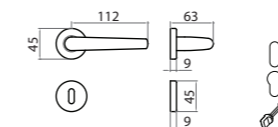

2 Ros 45x9  
 Mont. n°88

## FINESTRA

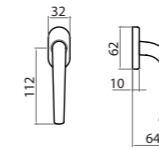

3  
 Mont. n°8



Per istruzioni di montaggio  
scansiona QR code,  
seleziona il numero di  
riferimento e segui le  
istruzioni.  
For assembly instructions  
scan the QR code, select the  
relevant assembly number  
and follow the instructions.



F1

F4

	F1	F3	F4	Conf. Pz.
1 Q8 BIL Coppia maniglie con Q8 (Bilancino) Pair handle with 8mm spindle	70142208001 9,10	70142208003 9,58	70142208004 9,58	10
2 Q8 R 45 Guarnitura Q8 ros. senza bocc. Lever handle 8mm on rose	70142280001 10,05	70142280003 11,29	70142280004 11,29	10
2 Q8 RB 45 Guarnitura Q8 ros./bocc. patent Lever handle 8mm on rose key hole escutcheon	70142281001 11,00	70142281003 13,00	70142281004 13,00	10
2 Q8 RBY 45 Guarnitura Q8 ros./bocc. yale Lever handle 8mm on rose - cyl. hole escutcheon	70142285001 11,00	70142285003 13,00	70142285004 13,00	10
3 Q8 R 50 Guarnitura Q8 ros. senza bocc. Lever handle 8mm on rose	70142230001 10,33	70142230003 11,43	70142230004 11,43	10
3 Q8 RB 50 Guarnitura Q8 ros./bocc. patent Lever handle 8mm on rose key hole escutcheon	70142231001 11,58	70142231003 13,43	70142231004 13,43	10
3 Q8 RBY 50 Guarnitura Q8 ros./bocc. yale Lever handle 8mm on rose - cyl. hole escutcheon	70142235001 11,58	70142235003 13,43	70142235004 13,43	10
4 Q8 RBWC Q6 50 Guarnitura Q8 ros./bocc. Wc Q6 Lever handle 8mm on wc key hole escutcheon 6mm	70142238001 16,58	70142238003 18,57	70142238004 18,57	10

## PORTA

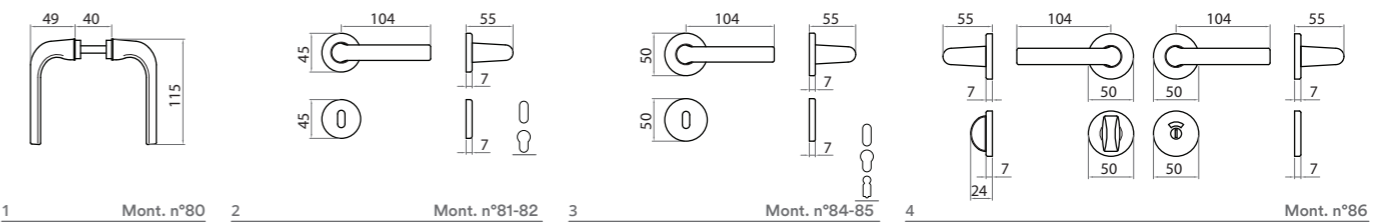

1 Mont. n°80 2 Mont. n°81-82 3 Mont. n°84-85 4 Mont. n°86

  Guarnitura senza molla di ritorno - Handle without spring  
Viti non in dotazione - Screws not provided



Per istruzioni di montaggio  
scansiona QR code,  
seleziona il numero di  
riferimento e segui le  
istruzioni.  
For assembly instructions  
scan the QR code, select the  
relevant assembly number  
and follow the instructions.



F1

F4

F9



F1



F1

	F1	F3	F4	F9	Conf. Pz.
1 Q8 BIL Coppia maniglie con Q8 (Bilancino) Pair handle with 8mm spindle	77438208001 9,82	77438208003 10,16	77438208004 10,16	77438208009 10,16	10
2 Q8 P90 Guarnitura Q8 placca patent 90 Lever handle 8mm on key plate 90	77438089001 13,75	77438089003 14,88	77438089004 14,88	77438089009 14,88	10
2 Q8 P70 Guarnitura Q8 placca patent 70 Lever handle 8mm on key plate 70	77438087001 13,75	77438087003 14,88	77438087004 14,88	77438087009 14,88	10
2 Q8 PY85 Guarnitura Q8 placca yale 85 Lever handle 8mm on cyl. plate 85	77438088501 13,75	77438088503 14,88	77438088504 14,88	77438088509 14,88	10
3 Q8 R 45 Guarnitura Q8 ros. senza bocc. Lever handle 8mm on rose	77438280001 10,77	77438280003 11,87	77438280004 11,87	77438280009 11,87	10
3 Q8 RB 45 Guarnitura Q8 ros./bocc. patent Lever handle 8mm on rose key hole escutcheon	77438281001 11,72	77438281003 13,58	77438281004 13,58	77438281009 13,58	10
3 Q8 RBY 45 Guarnitura Q8 ros./bocc. yale Lever handle 8mm on rose - cyl. hole escutcheon	77438285001 11,72	77438285003 13,58	77438285004 13,58	77438285009 13,58	10
4 Q8 R 50 Guarnitura Q8 ros. senza bocc. Lever handle 8mm on rose	77438230001 10,90	77438230003 12,00	77438230004 12,00	77438230009 12,00	10
4 Q8 RB 50 Guarnitura Q8 ros./bocc. patent Lever handle 8mm on rose key hole escutcheon	77438231001 12,15	77438231003 14,00	77438231004 14,00	77438231009 14,00	10
4 Q8 RBY 50 Guarnitura Q8 ros./bocc. yale Lever handle 8mm on rose - cyl. hole escutcheon	77438235001 12,15	77438235003 14,00	77438235004 14,00	77438235009 14,00	10
5 Q8 RBWC Q6 50 Guarnitura Q8 ros./bocc. Wc Q6 Lever handle 8mm on wc key hole escutcheon 6mm	77438238001 17,15	77438238003 19,14	77438238004 19,14	77438238009 19,14	10
5 DKx33 8SC BUS. 9,5 BRIXIA DKx33 8SC BUS. 9,5 window handle DK x 33mm with pins D.9,5	7743855830158 6,60	7743855830358 6,97	7743855830458 6,97	7743855830958 6,97	100
6 DKx35 8SC BUS. 9,5 BRIXIA DKx35 8SC BUS. 9,5 window handle DK x 35mm with pins D.9,5	7743855850158 6,60	7743855850358 6,97	7743855850458 6,97	7743855850958 6,97	100
6 DKx40 8SC BUS. 9,5 BRIXIA DKx40 8SC BUS. 9,5 window handle DK x 40mm with pins D.9,5	7743855800158 6,60	7743855800358 6,97	7743855800458 6,97	7743855800958 6,97	100
6 DKx45 8SC BUS. 9,5 BRIXIA DKx45 8SC BUS. 9,5 window handle DK x 45mm with pins D.9,5	7743855840158 6,60	7743855840358 6,97	7743855840458 6,97	7743855840958 6,97	100
7 BALCONY DOOR G.ra ros bocc yale per porta balcone Q7 - viti pass Lever handle 7mm on rect rose key hole esc metric-thread screw	77438227301 43,65	77438227303	77438227304	77438227309	50,20

## PORTA

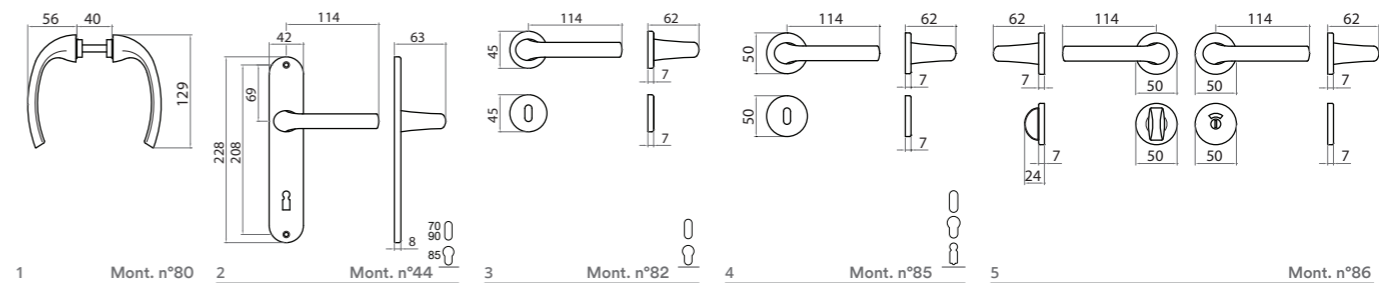

Guarnitura senza molla di ritorno - Handle without spring  
Viti non in dotazione - Screws not provided

## FINESTRA

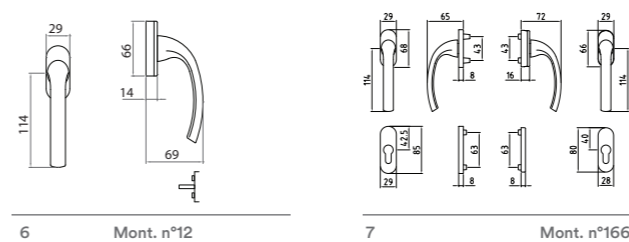

Per istruzioni di montaggio  
scansiona QR code,  
seleziona il numero di  
riferimento e segui le  
istruzioni.  
For assembly instructions  
scan the QR code, select the  
relevant assembly number  
and follow the instructions.

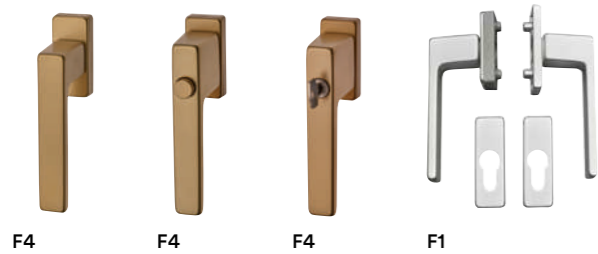

	F1	F4	F9	ANO	RAL9016	Conf. Pz.
1 Q8 BIL Coppia maniglie con Q8 (Bilancino) Pair handle with 8mm spindle	77502208001 10,80	77502208004 11,35	77502208009 11,35	77502208016 11,58	77502208080 11,35	10
2 Q8 RQ 45X45X10 Guarnitura Q8 ros. QUADRA senza bocc. Lever handle 8mm on square rose	77502240001 13,15	77502240004 14,25	77502240009 14,25	77502240016 15,08	77502240080 14,25	10
2 Q8 RQ 45X45X10 C/M Guarnitura Q8 ros. QUADRA senza bocc. con molla Lever handle 8mm on square rose springloaded	77502240501 15,15	77502240504 15,25	77502240509 15,25	77502240516 17,08	77502240580 15,25	10
2 Q8 RBQ 45X45X10 Guarnitura Q8 ros./bocc. QUADRA patent Lever handle 8mm on square rose key hole escutcheon	77502241001 16,00	77502241004 17,15	77502241009 17,15	77502241016 18,58	77502241080 17,15	10
2 Q8 RBQ 45X45X10 C/M Guarnitura Q8 ros./bocc. QUADRA patent con molla Lever handle 8mm on square rose key hole escutcheon springloaded	77502241501 18,00	77502241504 19,15	77502241509 19,15	77502241516 20,58	77502241580 19,15	10
2 Q8 RBQY 45X45X10 Guarnitura Q8 ros./bocc. QUADRA Yale Lever handle 8mm on square rose cyl hole escutcheon	77502245001 16,00	77502245004 17,15	77502245009 17,15	77502245016 18,58	77502245080 17,15	10
2 Q8 RBQY 45X45X10 C/M Guarnitura Q8 ros./bocc. QUADRA Yale con molla Lever handle 8mm on square rose cyl hole escutcheon springloaded	77502245501 18,00	77502245504 19,15	77502245509 19,15	77502245516 20,58	77502245580 19,15	10
3 Q8 RBR Guarnitura Q8 ros./bocc. RETT. patent Lever handle 8mm on springloaded rect rose key hole esc	77502281401 20,00	77502281404 21,15	77502281409 21,15	77502281416 22,58	77502281480 21,15	10
3 Q8 RBYR Guarnitura Q8 ros./bocc. rett.yale molla dx/sx Lever handle 8mm on springloaded rect rose - cyl. hole esc	77502285401 20,00	77502285404 21,15	77502285409 21,15	77502285416 22,58	77502285480 21,15	10
4 Q8 RBQWC Q6 45X45X10 Guarnitura Q8 ros./bocc. QUADRA Wc Q6 Lever handle 8mm on square rose wc hole escutcheon 6mm	77502248001 23,00	77502248004 24,45	77502248009 24,45	77502248016 26,18	77502248080 24,45	10
4 Q8 RBQWC Q6 45X45X10 C/M Guarnitura Q8 ros./bocc. QUADRA Wc Q6 con molla Lever handle 8mm on square rose wc hole escutcheon 6mm springloaded	77502248501 25,00	77502248504 26,45	77502248509 26,45	77502248516 28,18	77502248580 26,45	10
5 DK X 35 C/BUSS D.9,5 CARLO DKX35 8SC RET BUS.9,5 window handle DK x 35mm with pins D.9,5	7750255650108 6,61	7750255650408 7,89	7750255650908 7,89	7750255651608 8,50	7750255658008 5,59	100
5 DK X 40 C/BUSS D.9,5 CARLO DK Q7 x 40 con bussole D. 9,5 window handle DK x 40mm with pins D.9,5	7750255600108 6,61	7750255600408 7,89	7750255600908 10,25	7750255601608 8,50	7750255608008 5,59	20
5 DK X 45 C/BUSS D.9,5 CARLO DKX45 8SC RET BUS.9,5 window handle DK x 45mm with pins D.9,5	7750255640108 6,61	7750255640408 7,89	7750255640908 7,89	7750255641608 8,50	7750255648008 5,59	100
5 DK X 50 C/BUSS D.9,5 CARLO DKX50 8SC RET BUS.9,5 window handle DK x 50mm with pins D.9,5	7750255660108 6,61	7750255660408 7,89	7750255660908 7,89	7750255661608 8,50	7750255668008 5,59	100
6 DK X 40 C/BUSS D.9,5 CARLO con pulsante DK Q7 x 40 con bussole D. 9,5 window handle DK x 40mm with pins D.9,5	77502562501 23,41	77502562504 25,14	77502562509 32,70	77502562516 39,41	77502562580 28,19	5
7 DK X 45 C/BUSS D.9,5 CARLO con chiave DK Q7 x 45 con bussole D. 9,5 window handle DK x 45mm with pins D.9,5	77502563301 27,52	77502563304 29,61	77502563309 38,44	77502563316 35,65	77502563380 26,20	5
7 DK X 40 C/BUSS D.9,5 CARLO con chiave DK Q7 x 40 con bussole D. 9,5 window handle DK x 40mm with pins D.9,5	77502563501 27,52	77502563504 29,61	77502563509 38,44	77502563516 35,65	77502563580 26,20	5
8 BALCONY DOOR G.ra ros bocc yale per porta balcone Q7 - viti pass Lever handle 7mm on rect rose key hole esc. metric-thread screw	77502217301 60,14	77502217304 62,99	77502217309 62,99	77502217316 77,73	77502217380 57,91	
9 BALCONY DOOR G.ra ros bocc yale per porta balcone Q7 - viti pass Lever handle 7mm on rect rose key hole esc. metric-thread screw	77502217501 62,99	77502217504 65,84	77502217509 65,84	77502217516 81,29	77502217580 60,75	

PORTA

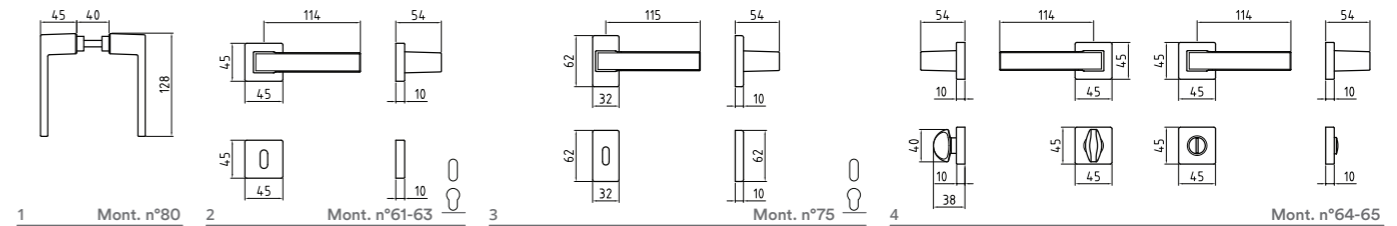

Guarnitura con molla di ritorno - Handle with spring  
Viti non in dotazione - Screws not provided

FINESTRA

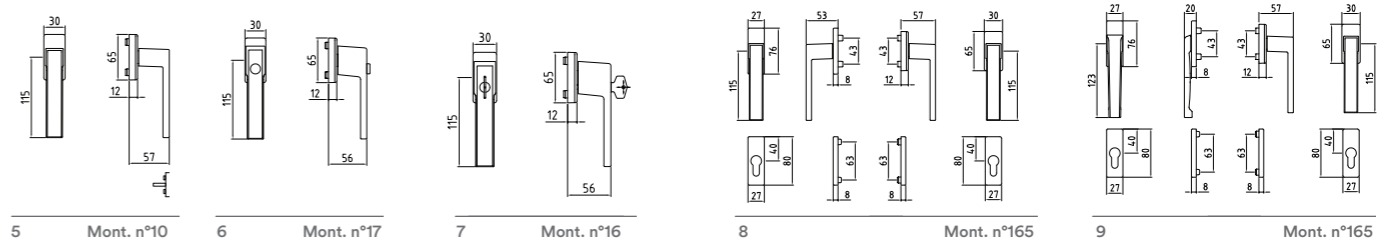



F1



F4



F4

	F1	F3	F4	Conf. Pz.
1 Q8 BIL Coppia maniglie con Q8 (Bilancino) Pair handle with 8mm spindle	77400208001 9,82	77400208003 10,16	77400208004 10,16	10
2 Q8 P90 Guarnitura Q8 placca patent 90 Lever handle 8mm on key plate 90	77400089001 13,28	77400089003 14,38	77400089004 14,38	10
2 Q8 P70 Guarnitura Q8 placca patent 70 Lever handle 8mm on key plate 70	77400087001 13,28	77400087003 14,38	77400087004 14,38	10
2 Q8 PY85 Guarnitura Q8 placca yale 85 Lever handle 8mm on cyl. plate 85	77400088501 13,28	77400088503 14,38	77400088504 14,38	10
2 Q8 P90 fissa Guarnitura Q8 placca patent 90 fissa Lever handle 8mm on fixed key plate 90	7740008900153 14,28	7740008900353 14,38	7740008900453 14,38	10
2 Q8 P70 fissa Guarnitura Q8 placca patent 70 fissa Lever handle 8mm on key plate 70	7740008700153 14,28	7740008700353 14,38	7740008700453 14,38	10
2 Q8 PY85 fissa Guarnitura Q8 placca yale 85 fissa Lever handle 8mm on fixed cylinder plate 85 packing 50 pairs	7740008850153 14,28	7740008850353 14,38	7740008850453 14,38	10
3 Q8 R 45 Guarnitura Q8 ros. senza bocc. Lever handle 8mm on rose	77400280001 10,77	77400280003 11,87	77400280004 11,87	10
3 Q8 RB 45 Guarnitura Q8 ros./bocc. patent Lever handle 8mm on rose key hole escutcheon	77400281001 11,72	77400281003 13,58	77400281004 13,58	10
3 Q8 RBY 45 Guarnitura Q8 ros./bocc. yale Lever handle 8mm on rose - cyl. hole escutcheon	77400285001 11,72	77400285003 13,58	77400285004 13,58	10
4 Q8 R 50 Guarnitura Q8 ros. senza bocc. Lever handle 8mm on rose	77400230001 10,90	77400230003 12,00	77400230004 12,00	10
4 Q8 RB 50 Guarnitura Q8 ros./bocc. patent Lever handle 8mm on rose key hole escutcheon	77400231001 12,15	77400231003 14,00	77400231004 14,00	10
4 Q8 RBY 50 Guarnitura Q8 ros./bocc. yale Lever handle 8mm on rose - cyl. hole escutcheon	77400235001 12,15	77400235003 14,00	77400235004 14,00	10
5 Q8 RBWC Q6 50 Guarnitura Q8 ros./bocc. Wc Q6 Lever handle 8mm on wc key hole escutcheon 6mm	77400238001 17,15	77400238003 19,14	77400238004 19,14	10
6 DK X 33 C/BUSS D.9,5 GABRY TN DKx33 RETT BUS window handle DK x 33mm with pins D.9,5	7740055600158 6,60	7740055600358 6,97	7740055600458 6,97	100
6 DK X 35 C/BUSS D.9,5 GABRY TN DKx35 RETT BUS window handle DK x 35mm with pins D.9,5	7740055650158 6,60	7740055650358 6,97	7740055650458 6,97	100
6 DK X 40 C/BUSS D.9,5 GABRY TN DKx40 RETT BUS window handle DK x 40mm with pins D.9,5	7740055630158 6,60	7740055630358 6,97	7740055630458 6,97	100
6 DK X 45 C/BUSS D.9,5 GABRY TN DKx45 RETT BUS window handle DK x 45mm with pins D.9,5	7740055640158 6,60	7740055640358 6,97	7740055640458 6,97	100

## PORTA

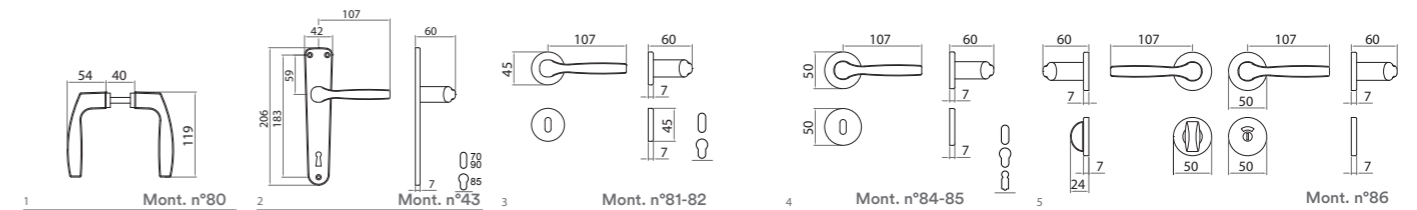

## FINESTRA

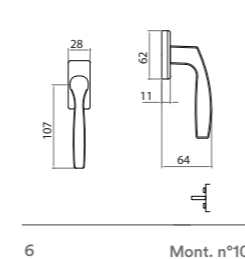

Per istruzioni di montaggio  
scansiona QR code,  
seleziona il numero di  
riferimento e segui le  
istruzioni.  
For assembly instructions  
scan the QR code, select the  
relevant assembly number  
and follow the instructions.

# GM05

ZAMA

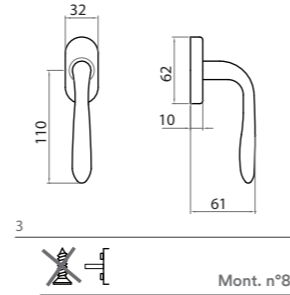

3

Mont. n°8

	ZGV	ZCL	GCTOL	ZCS	Conf. Pz.
3 DK X 40 Martellina DK Q7 x 40 window handle DK x 40 mm	6GM58557004	6GM58557007	6GM58557012	6GM58557013	2
	17,38	18,08	14,33	13,08	
3 DK X 40 C/BUSS. Martellina DK Q7 x 40 con bussole D. 9,5 window handle DK x 40mm with pins D.9,5	6GM58558004	6GM58558007	6GM58558012	6GM58558013	2
	13,80	14,50	10,75	9,50	



Per istruzioni di montaggio  
scansiona QR code,  
seleziona il numero di  
riferimento e segui le  
istruzioni.  
For assembly instructions  
scan the QR code, select the  
relevant assembly number  
and follow the instructions.

# GM08

ZAMA

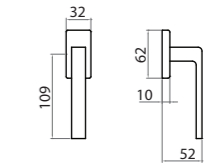

3



Mont. n°6

	ZCL	ZCS	Conf. Pz.
3 DK X 40 Martellina DK Q7 x 40 window handle DK x 40 mm	6GM08555007	6GM08555013	2
	25,96	20,96	
3 DK X 40 C/BUSS. Martellina DK Q7 x 40 con bussole D. 9,5 window handle DK x 40mm with pins D.9,5	6GM08556007	6GM08556013	2
	20,14	15,14	



Per istruzioni di montaggio  
scansiona QR code,  
seleziona il numero di  
riferimento e segui le  
istruzioni.  
For assembly instructions  
scan the QR code, select the  
relevant assembly number  
and follow the instructions.

# GM11

ZAMA

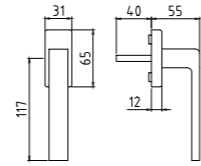

	ZCL	ZCS	Conf. Pz.
3 DK X 40 C/BUSS. Martellina DK Q7 x 40 con bussole D. 9,5 window handle DK x 40mm with pins D.9,5	6GM11553807	6GM11553813	2
	20,28	15,28	



Per istruzioni di montaggio scansiona QR code, seleziona il numero di riferimento e segui le istruzioni.  
For assembly instructions scan the QR code, select the relevant assembly number and follow the instructions.

# MILENA Z

ZAMA

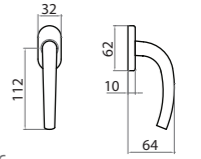

	ZCL	GCTOL	ZCS	Conf. Pz.
6 DK X 40 Martellina DK Q7 x 40 window handle DK x 40 mm	66744557007	66744557012	66744557013	2
	17,44	13,69	12,45	
6 DK X 40 C/BUSS. Martellina DK Q7 x 40 con bussole D. 9,5 window handle DK x 40mm with pins D.9,5	66744558007	66744558012	66744558013	2
	17,44	13,69	12,45	



Per istruzioni di montaggio scansiona QR code, seleziona il numero di riferimento e segui le istruzioni.  
For assembly instructions scan the QR code, select the relevant assembly number and follow the instructions.



# BRIXIA 2

ALLUMINIO

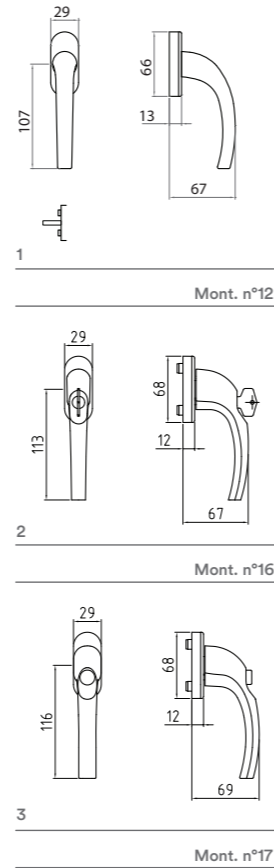

	F1	F3	F4	Conf. Pz.
1 DKx33 8SC BUS. 9,5 BRIXIA/2 DKx33 8SC BUS. 9,5 window handle DK x 33mm with pins D.9,5	7743355830158	7743355830358	7743355830458	100
1 DKx35 8SC BUS. 9,5 BRIXIA/2 DKx35 8SC BUS. 9,5 window handle DK x 35mm with pins D.9,5	7743355850158	7743355850358	7743355850458	100
1 DKx40 8SC BUS. 9,5 BRIXIA/2 DKx40 8SC BUS. 9,5 window handle DK x 40mm with pins D.9,5	7743355800158	7743355800358	7743355800458	100
1 DKx45 8SC BUS. 9,5 BRIXIA/2 DKx45 8SC BUS. 9,5 window handle DK x 45mm with pins D.9,5	7743355840158	7743355840358	7743355840458	100
2 DK X 40 C/BUSS D.9,5 BRIXIA/2 con chiave DK Q7 x 40 con bussole D. 9,5 window handle DK x 40mm with pins D.9,5	77433563501	77433563503	77433563504	5
3 DK X 40 C/BUSS D.9,5 BRIXIA/2 con pulsante DK Q7 x 40 con bussole D. 9,5 window handle DK x 40mm with pins D.9,5	77433562501	77433562503	77433562504	5

	RAL9010	RAL1013	ANO	RAL9016	Conf. Pz.
1 DKx33 8SC BUS. 9,5 BRIXIA/2 DKx33 8SC BUS. 9,5 window handle DK x 33mm with pins D.9,5	7743355830758	7743355831058	7743355831658	7743355838058	100
1 DKx35 8SC BUS. 9,5 BRIXIA/2 DKx35 8SC BUS. 9,5 window handle DK x 35mm with pins D.9,5	7743355850758	7743355851058	7743355851658	7743355858058	100
1 DKx40 8SC BUS. 9,5 BRIXIA/2 DKx40 8SC BUS. 9,5 window handle DK x 40mm with pins D.9,5	7743355800758	7743355801058	7743355801658	7743355808058	100
1 DKx45 8SC BUS. 9,5 BRIXIA/2 DKx45 8SC BUS. 9,5 window handle DK x 45mm with pins D.9,5	7743355840758	7743355841058	7743355841658	7743355848058	100
2 DK X 40 C/BUSS D.9,5 BRIXIA/2 con chiave DK Q7 x 40 con bussole D. 9,5 window handle DK x 40mm with pins D.9,5	77433563607	77433563510	77433563516	77433563580	5
3 DK X 40 C/BUSS D.9,5 BRIXIA/2 con pulsante DK Q7 x 40 con bussole D. 9,5 window handle DK x 40mm with pins D.9,5	77433562507	77433562510	77433562516	77433562580	5

# CARLO

ALLUMINIO

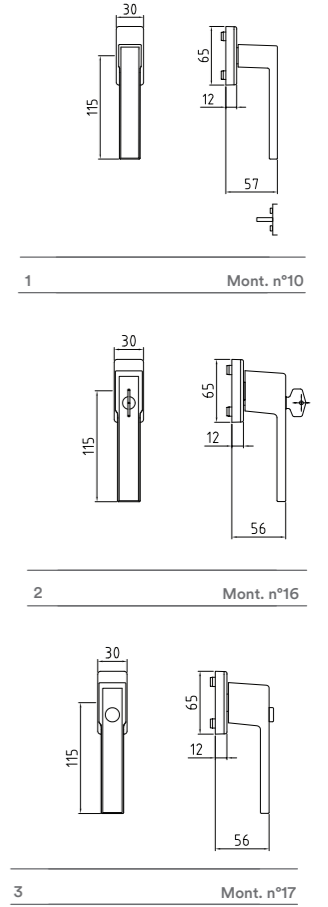

	F1	F3	F4	F9	Conf. Pz.
1 DK X 35 C/BUSS D.9,5 CARLO DKX35 8SC RET BUS.9,5 window handle DK x 35mm with pins D.9,5	7750255650108	7750255650308	7750255650408	7750255650908	100
1 DK X 40 C/BUSS D.9,5 CARLO DK Q7 x 40 con bussole D. 9,5 window handle DK x 40mm with pins D.9,5	7750255600108	7750255600308	7750255600408	7750255600908	20
1 DK X 45 C/BUSS D.9,5 CARLO DKX45 8SC RET BUS.9,5 window handle DK x 45mm with pins D.9,5	7750255640108	7750255640308	7750255640408	7750255640908	100
1 DK X 50 C/BUSS D.9,5 CARLO DKX50 8SC RET BUS.9,5 window handle DK x 50mm with pins D.9,5	7750255660108	7750255660308	7750255660408	7750255660908	100
2 DK X 45 C/BUSS D.9,5 CARLO con chiave DK Q7 x 45 con bussole D. 9,5 window handle DK x 45mm with pins D.9,5	77502563301	77502563303	77502563304	77502563309	5
2 DK X 40 C/BUSS D.9,5 CARLO con chiave DK Q7 x 40 con bussole D. 9,5 window handle DK x 40mm with pins D.9,5	77502563501	77502563503	77502563504		5
3 DK X 40 C/BUSS D.9,5 CARLO con pulsante DK Q7 x 40 con bussole D. 9,5 window handle DK x 40mm with pins D.9,5	77502562501	77502562503	77502562504	77502562509	5

	RAL9010	RAL1013	ANO	RAL9016	Conf. Pz.
1 DK X 35 C/BUSS D.9,5 CARLO DKX35 8SC RET BUS.9,5 window handle DK x 35mm with pins D.9,5	7750255650708	7750255651008	7750255651608	7750255658008	100
1 DK X 40 C/BUSS D.9,5 CARLO DK Q7 x 40 con bussole D. 9,5 window handle DK x 40mm with pins D.9,5	7750255600708	7750255601008	7750255601608	7750255608008	20
1 DK X 45 C/BUSS D.9,5 CARLO DKX45 8SC RET BUS.9,5 window handle DK x 45mm with pins D.9,5	7750255640708	7750255641008	7750255641608	7750255648008	100
1 DK X 50 C/BUSS D.9,5 CARLO DKX50 8SC RET BUS.9,5 window handle DK x 50mm with pins D.9,5	7750255660708	7750255661008	7750255661608	7750255668008	100
2 DK X 45 C/BUSS D.9,5 CARLO con chiave DK Q7 x 45 con bussole D. 9,5 window handle DK x 45mm with pins D.9,5	77502563307	77502563310	77502563316	77502563380	5
2 DK X 40 C/BUSS D.9,5 CARLO con chiave DK Q7 x 40 con bussole D. 9,5 window handle DK x 40mm with pins D.9,5	77502563507	77502563510	77502563516	77502563580	5
3 DK X 40 C/BUSS D.9,5 CARLO con pulsante DK Q7 x 40 con bussole D. 9,5 window handle DK x 40mm with pins D.9,5	77502562507	77502562510	77502562516	77502562580	5

# GABRY

ALLUMINIO

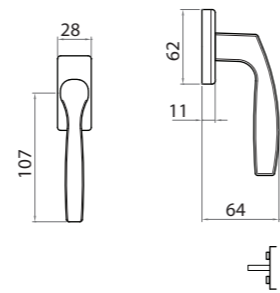

1  
Mont. n°10

	F1	F3	F4	Conf. Pz.
1 DK X 33 C/BUSS D.9,5 GABRY TN DKx33 RETT BUS window handle DK x 33mm with pins D.9,5	7740055600158	7740055600358	7740055600458	100
	6,60	6,97	6,97	
1 DK X 35 C/BUSS D.9,5 GABRY TN DKx35 RETT BUS window handle DK x 35mm with pins D.9,5	7740055650158	7740055650358	7740055650458	100
	6,60	6,97	6,97	
1 DK X 40 C/BUSS D.9,5 GABRY TN DKx40 RETT BUS window handle DK x 40mm with pins D.9,5	7740055630158	7740055630358	7740055630458	100
	6,60	6,97	6,97	
1 DK X 45 C/BUSS D.9,5 GABRY TN DKx45 RETT BUS window handle DK x 45mm with pins D.9,5	7740055640158	7740055640358	7740055640458	100
	6,60	6,97	6,97	



Per istruzioni di montaggio scansiona QR code, seleziona il numero di riferimento e segui le istruzioni.  
For assembly instructions scan the QR code, select the relevant assembly number and follow the instructions.

# KIT SCORRI TONDO BLOCC C/SERR ECO

ZAMA

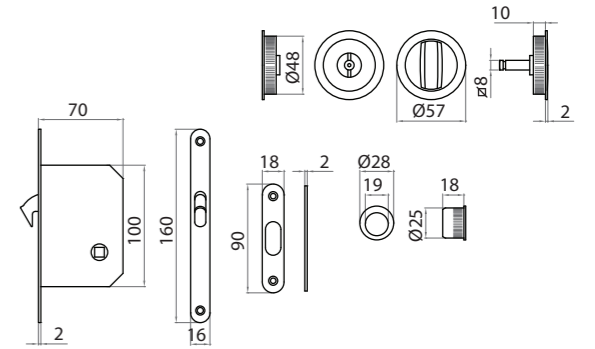
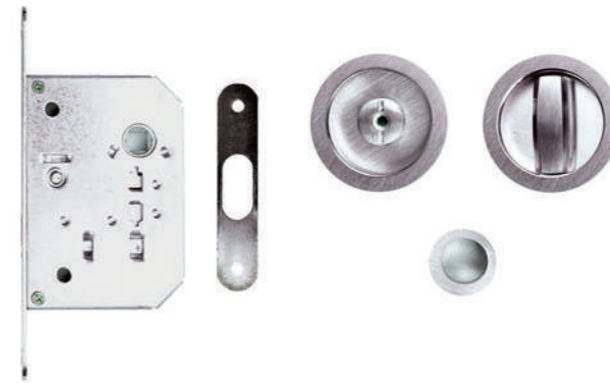

Mont. n°122

ADATTO PER SPESSORE PANNELLO mm 44, ± 1mm

	ZCL	GCTOL	ZCS	Conf. Pz.
KIT SCORRI TONDO BLOCC c/serratura eco	66048718807	66048718812	66048718813	1
Sliding door handle with lock	20,46	20,46	13,86	

# KIT SCORRI QT BLOCC SERR. ECO

ZAMA

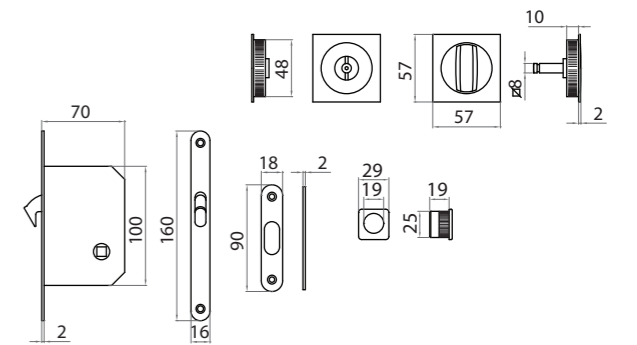
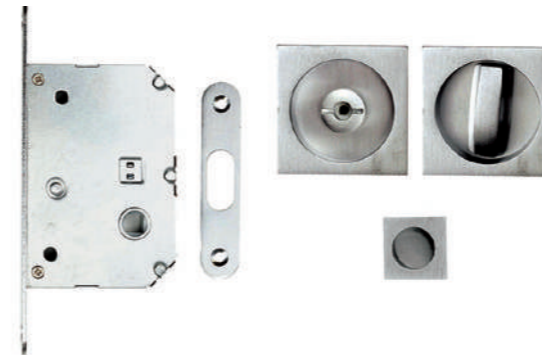

Mont. n°117

	ZCL	GCTOL	ZCS	Conf. Pz.
KIT SCORRI QT BLOCC c/serratura eco	66048724807	66048724812	66048724813	1
Square sliding door handle with lock	25,17	25,17	14,85	



Per istruzioni di montaggio scansiona QR code, seleziona il numero di riferimento e segui le istruzioni.  
For assembly instructions scan the QR code, select the relevant assembly number and follow the instructions.

# KIT SCORRI TONDO BLOCC C-S/SERR. SMART

ZAMA - ALLUMINIO

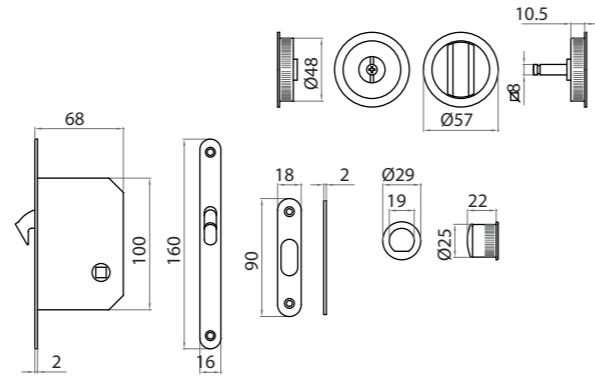

Mont. n°122

	ZCS/F1-SAT	Conf. Pz.
SCORRI TONDO BLOCC s/serratura SMART	66248714213	1
Sliding door handle without lock	12,17 ⚡	
SCORRI TONDO BLOCC c/serratura SMART	66248714813	1
Sliding door handle with lock	16,92	

⚡ Servizio G48: Articolo a magazzino e disponibile entro 48 dall'elaborazione dell'ordine. In base a disponibilita' e condizioni di vendita.  
G48 service: Item in stock and available within 48 hours of order processing. Based on availability and sales conditions.

# KIT SCORRI QT BLOCC C-S/SERR. SMART

ZAMA - ALLUMINIO

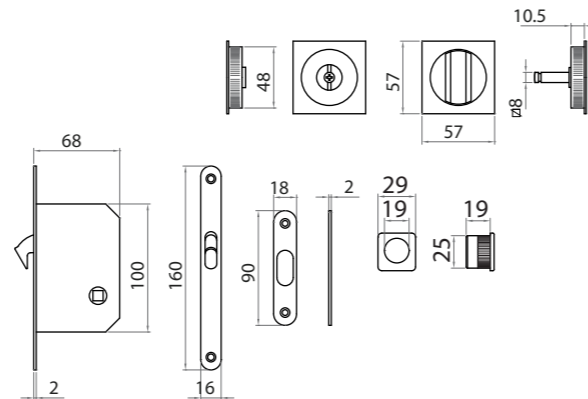

Mont. n°117

	ZCS/F1-SAT	Conf. Pz.
SCORRI QT BLOCC s/serratura SMART	66248724213	1
Square slidding door without lock	12,17 ⚡	
SCORRI QT BLOCC c/serratura SMART	66248724813	1
Sliding door handle with lock	16,92	

⚡ Servizio G48: Articolo a magazzino e disponibile entro 48 dall'elaborazione dell'ordine. In base a disponibilita' e condizioni di vendita.  
G48 service: Item in stock and available within 48 hours of order processing. Based on availability and sales conditions.

# 7

Porte d'ingresso

Entrance doors

- 408 Pomoli / Knobs
- 415 Maniglioni fissi / Pull handles
- 420 Battenti / Boor knockers
- 422 Rosette, bocchette, placche per porte blindate /  
Accessories for armored doors
- 428 Maniglie singole / Single handles
- 430 Nottolini limitatori d'apertura per porte blindate  
Knobs for opening limiting device armored doors
- 433 Kit per porte basculanti  
Garage door handle kit



OLV

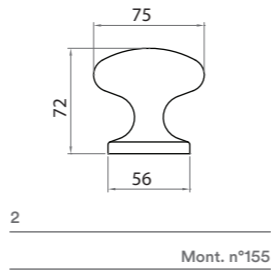
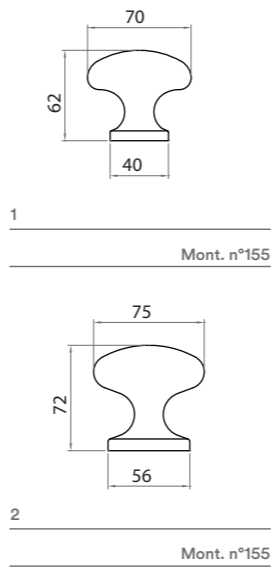

	OLV	OCS	OGV	OCL	OS	Conf. Pz.
1 POM 70 CP Pomolo mm 70 centroporta knob mm 70	5GM96770301	5GM96770303	5GM96770304	5GM96770307	5GM96770308	1
	25,89	32,44	28,42	32,44	28,42	
2 POM 75 CP Pomolo mm 75 centroporta knob mm 75	5GM96770501	5GM96770503	5GM96770504	5GM96770507	5GM96770508	1
	27,59	34,59	28,42	32,44	28,42	

OTTONE



OLV

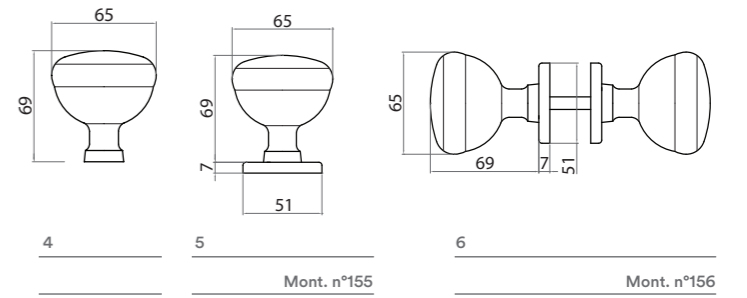
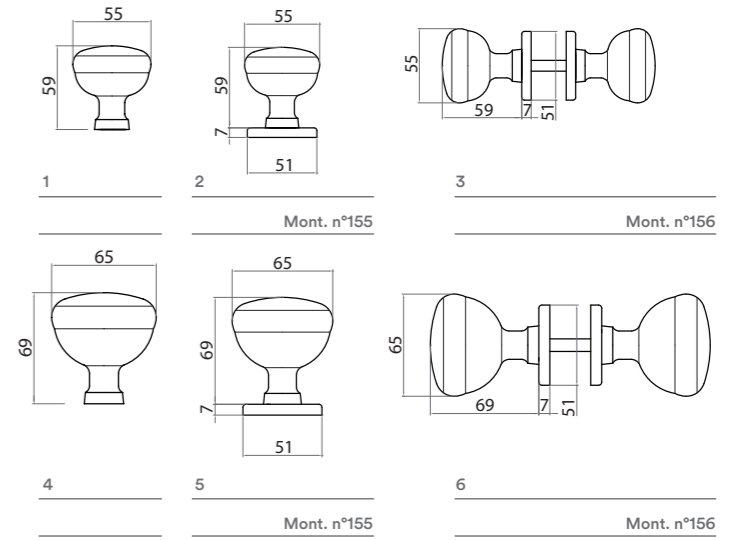

	OLV	OCS	OGV	OCL	OS	Conf. Pz.
1 POM55 M10/Q8 S/ROS Pomolo mm 55 fisso/girevole senza rosetta knob mm 55 fix/turnable w/o rose	55744855601	55744855603	55744855604	55744855607	55744855608	10
	28,42	34,82	28,42	34,82	28,42	
2 POM55 CP R51x7 Pomolo mm 55 centroporta rosetta 51x7 knob mm 55 on rose 51x7	55744755501	55744755503	55744755504	55744755507	55744755508	1
	32,59	39,73	32,59	39,73	32,59	
3 POM55 Q8CP R51x7 Pomoli mm 55 Q8 accoppiati rosetta 51x7 Pair of knobs D55 on rose 51x7mm	55744751001	55744751003	55744751004	55744751007	55744751008	1
	58,48	66,07	58,48	66,07	58,48	
4 POM70 M10/Q8 S/ROS Pomolo mm 70 fisso/girevole senza rosetta knob mm 70 fix/turnable w/o rose	55744875601	55744875603	55744875604	55744875607	55744875608	10
	34,52	43,45	34,52	43,45	34,52	
5 POM70 CP R51X7 Pomolo mm 70 centroporta rosetta 51x7 knob mm 70 on rose 51x7	55744770501	55744770503	55744770504	55744770507	55744770508	1
	38,69	48,36	38,69	48,36	38,69	
6 POM70 Q8CP R51x7 Pomoli mm 70 Q8 accoppiati rosetta 51x7 Pair of knobs D70 on rose 51x7mm	55744771001	55744771003	55744771004	55744771007	55744771008	1
	65,03	79,31	65,03	79,31	65,03	



GCTOL

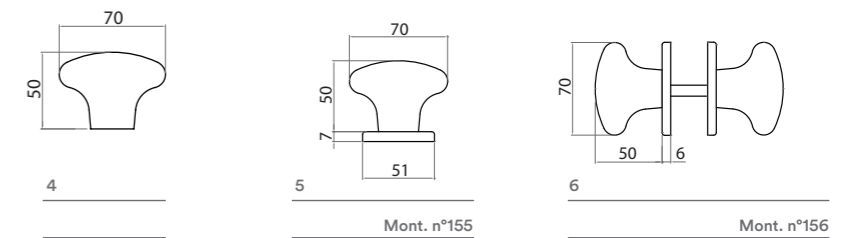
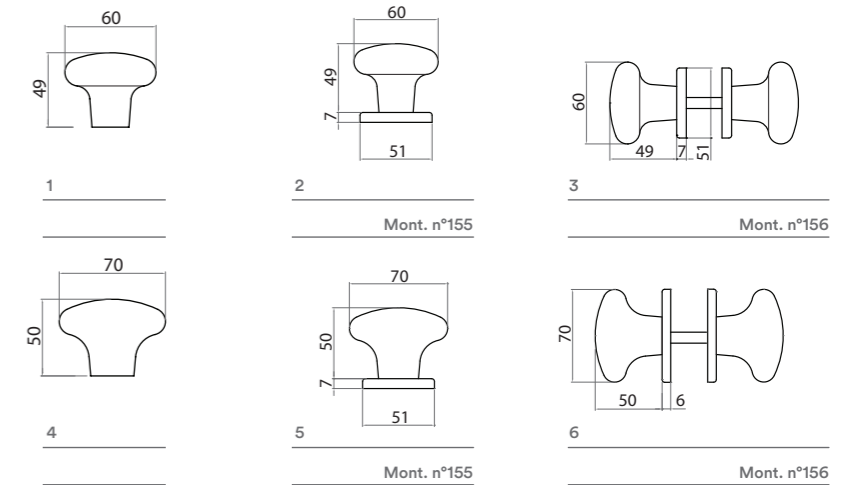

	OLV	OCS	OGV	OCL	OS	Conf. Pz.
1 POM60 M10/Q8 S/ROS PEGASO POM60 M10 Q8 knob mm 60 fix/turnable w/o rose	44890865601	44890865603	44890865604	44890865607	44890865608	10
	27,53	36,46	30,50	36,46	30,50	
2 POM60 CP R51x7 Pomolo mm 60 centroporta rosetta 51x7 knob mm 60 on rose 51x7	44890755501	44890755503	44890755504	44890755507	44890755508	1
	31,69	41,37	35,12	41,37	35,12	
3 POM60 Q8CP R51x7 Pomoli mm 60 Q8 accoppiati rosetta 51x7 Pair of knobs D60 on rose 51x7mm	44890751001	44890751003	44890751004	44890751007	44890751008	1
	63,39	82,73	70,08	82,73	70,08	
4 POM70 M10/Q8 S/ROS PEGASO POM70 M10 Q8 knob mm 70 fix/turnable w/o rose	44890875601	44890875603	44890875604	44890875607	44890875608	10
	29,46	38,39	32,44	38,39	32,44	
5 POM70 CP R51X7 Pomolo mm 70 centroporta rosetta 51x7 knob mm 70 on rose 51x7	44890770501	44890770503	44890770504	44890770507	44890770508	1
	33,63	43,30	37,05	43,30	37,05	
6 POM70 Q8CP R51x7 Pomoli mm 70 Q8 accoppiati rosetta 51x7 Pair of knobs D70 on rose 51x7mm	44890771001	44890771003	44890771004	44890771007	44890771008	1
	67,41	86,60	74,10	86,60	74,10	

OTTONE



Per istruzioni di montaggio scansiona QR code, seleziona il numero di riferimento e segui le istruzioni.  
For assembly instructions scan the QR code, select the relevant assembly number and follow the instructions.

## BLINDO

OTTONE



GCTOL

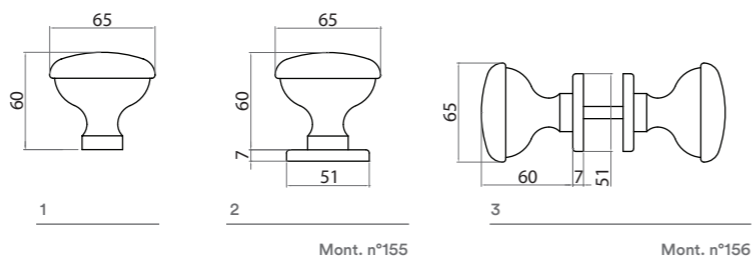

	OLV	OCS	OGV	OCL	OS	Conf. Pz.
1 POM65 M10/Q8 S/ROS BLINDO POM MM65 M10/Q8 knob mm 65 fix/turnable w/o rose	55694875601	55694875603	55694875604	55694875607	55694875608	10
2 POM65 CP R51x7 Pomolo mm 65 centroporta rosetta 51x7 knob mm 65 on rose 51x7	55694770501	55694770503	55694770504	55694770507	55694770508	1
3 POM65 Q8CP R51x7 Pomoli mm 65 Q8 accoppiati rosetta 51x7 Pair of knobs D65 on rose 51x7mm	55694771001	55694771003	55694771004	55694771007	55694771008	1

## UNIVERSAL

ALLUMINIO



F4

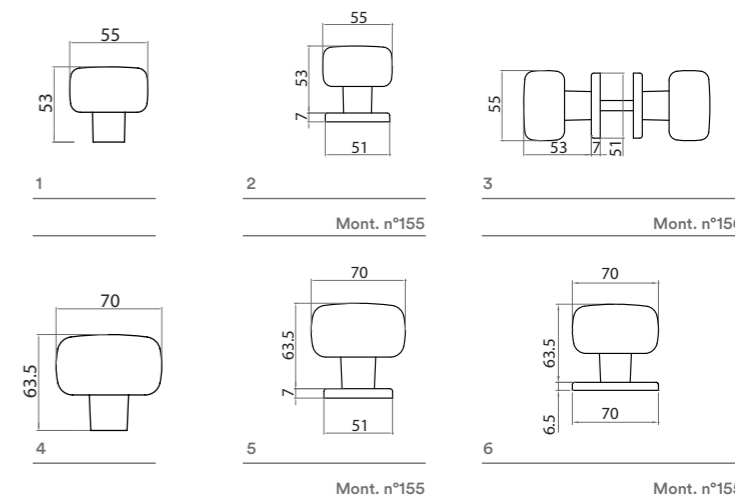

	F1	F4	GCTOL	GCTOS	GCTCL	GCTCS	Conf. Pz.
1 POM55 M10/Q8 S/ROS Pomolo mm 55 fisso/girevole senza rosetta knob mm 55 fix/turnable w/o rose	77486855601	77486855604	77486855612	77486855623	77486855624	77486855625	10
2 POM55 CP R51x7 Pomolo mm 55 centroporta rosetta 51x7 knob mm 55 on rose 51x7	77486755501	77486755504	77486755512	77486755523	77486755524	77486755525	1
3 POM55 Q8CP R51x7 Pomoli mm 55 Q8 accoppiati rosetta 51x7 Pair of knobs D55 on rose 51x7mm	77486751001	77486751004	77486751012	77486751023	77486751024	77486751025	1
4 POM70 M10/Q8 S/ROS Pomolo mm 70 fisso/girevole senza rosetta knob mm 70 fix/turnable w/o rose	77486875601	77486875604	77486875612	77486875623	77486875624	77486875625	10
5 POM70 CP R51x7 Pomolo mm 70 centroporta rosetta 51x7 knob mm 70 on rose 51x7	77486770501	77486770504	77486770512	77486770523	77486770524	77486770525	1
6 POM70 CP R70x6 Pomolo mm 70 centroporta rosetta 70x6 knob mm 70 on rose 70x6	7748687560107	7748687560407	7748687561207	7748687562307	7748687562407	7748687562507	1

## YORK

ZAMA



ZCS

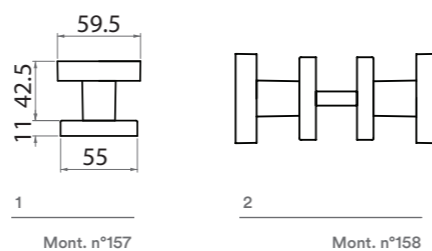

	ZCL	ZCS	CHAMPAGNE	NORMANDIA	LORENA	BORGOGNA	Conf. Pz.
1 POM60 X60 CP R55x55 YORK POM60X60 CP R55x55 knob mm 60 on rose 55x55	66460770207	66460770213	66460770243	66460770244	66460770246	66460770247	1
2 POM60X60 Q8CP R55x55 YORK POM60X60 Q8CP R55x55 pair of knobs mm 60X60 8mm rose 55X55	66460771007	66460771013	66460771043	66460771044	66460771046	66460771047	1

## SUSY

ALLUMINIO



F4

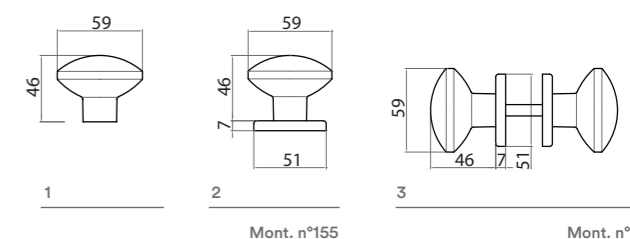

	F1	F4	GCTOL	GCTOS	GCTCL	GCTCS	Conf. Pz.
POM60 M10/Q8 S/ROS Pomolo mm 60 fisso/girevole senza rosetta knob mm 60 fix/turnable w/o rose	77434865601	77434865604	77434865612	77434865623	77434865624	77434865625	10
POM60 CP R51x7 Pomolo mm 60 centroporta rosetta 51x7 knob mm 60 on rose 51x7	77434755501	77434755504	77434755512	77434755523	77434755524	77434755525	1
1 POM60 Q8CP R51x7 Pomoli mm 60 Q8 accoppiati rosetta 51x7 Pair of knobs D60 on rose 51x7mm	77434751001	77434751004	77434751012	77434751023	77434751024	77434751025	1



Per istruzioni di montaggio scansiona QR code, seleziona il numero di riferimento e segui le istruzioni.  
For assembly instructions scan the QR code, select the relevant assembly number and follow the instructions.



Per istruzioni di montaggio scansiona QR code, seleziona il numero di riferimento e segui le istruzioni.  
For assembly instructions scan the QR code, select the relevant assembly number and follow the instructions.

## PEGASO

ALLUMINIO



OLV-M1

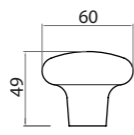

1

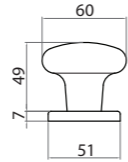

2

Mont. n°155

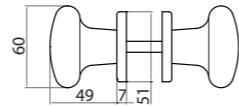

3

Mont. n°156

	F1	F4	GCTOL	GCTOS	GCTCL	GCTCS	Conf. Pz.
1 POM60 M10/Q8 S/ROS Pomolo mm 60 fisso/girevole senza rosetta knob mm 60 fix/turnable w/o rose	70143865601 12,20	70143865604 12,20	70143865612 14,28	70143865623 18,60	70143865624 14,28	70143865625 18,60	10
2 POM60 CP R51x7 Pomolo mm 60 centroporta rosetta 51x7 knob mm 60 on rose 51x7	70143755501 14,73	70143755504 14,73	70143755512 17,56	70143755523 22,92	70143755524 17,56	70143755525 22,92	1
3 POM60 Q8CP R51x7 Pomoli mm 60 Q8 accoppiati rosetta 51x7 Pair of knobs D60 on rose 51x7mm	70143751001 29,46	70143751004 29,46	70143751012 35,12	70143751023 45,68	70143751024 35,12	70143751025 45,68	1

## WING

ALLUMINIO



ACS

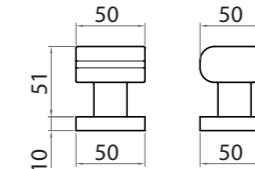

1

Mont. n°157

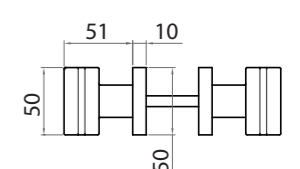

2

Mont. n°158

	ACS	ACL	Conf. Pz.
1 POM50 CP R50x50 WING POM50 CP R50x50 knob mm 55 on rose 50x50	77792755513 28,87	77792755517 29,31	1
2 POM50 Q8CP R50x50 WING POM50 Q8CP R50x50 pair of knobs mm 50 8mm rose 50x50	77792751013 60,12	77792751017 60,12	1

## BLINDO

ALLUMINIO



F4

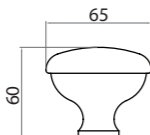

1

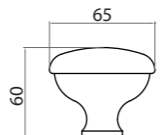

2

Mont. n°155

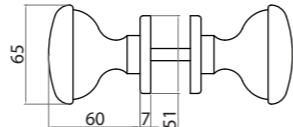

3

Mont. n°156

	F4	GCTOL	GCTOS	GCTCL	GCTCS	Conf. Pz.
1 POM65 M10/Q8 S/ROS Pomolo mm 65 fisso/girevole senza rosetta knob mm 65 fix/turnable w/o rose	77194875604 12,20	77194875612 14,28	77194875623 18,60	77194875624 14,28	77194875625 18,60	10
2 POM65 CP R51X7 Pomolo mm 65 centroporta rosetta 51x7 knob mm 65 on rose 51x7	77194770504 14,73	77194770512 17,56	77194770523 22,92	77194770524 17,56	77194770525 22,92	1
3 POM65 Q8CP R51x7 Pomoli mm 65 Q8 accoppiati rosetta 51x7 Pair of knobs D65 on rose 51x7mm	77194771004 29,46	77194771012 35,12	77194771023 45,68	77194771024 35,12	77194771025 45,68	1

## FRAME

ALLUMINIO



F1-SAT

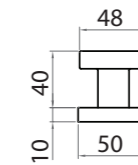

1

Mont. n°157

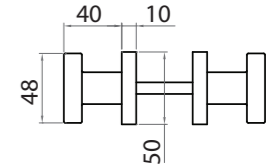

2

Mont. n°158

	ACL	F1-SAT	Conf. Pz.
1 POM50 CP R50x50 FRAME POM50 CP R50x50 knob mm 55 on rose 50x50	77472755517 31,55	77472755533 25,59	1
2 POM50 Q8CP R50x50 FRAME POM50 Q8CP R50x50 pair of knobs mm 50 8mm rose 50x50	77472751017 65,32	77472751033 52,23	1



Per istruzioni di montaggio  
scansiona QR code,  
seleziona il numero di  
riferimento e segui le  
istruzioni.  
For assembly instructions  
scan the QR code, select the  
relevant assembly number  
and follow the instructions.



Per istruzioni di montaggio  
scansiona QR code,  
seleziona il numero di  
riferimento e segui le  
istruzioni.  
For assembly instructions  
scan the QR code, select the  
relevant assembly number  
and follow the instructions.

## 7071

ALLUMINIO

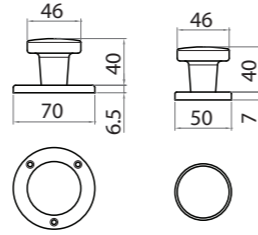

	F1	F3	F4	F9	Conf. Pz.
POM FISSO R70 VV 7071/K2 R70 FISSO 3FV fixed knob on 70 mm round rose screws in view	7707174000119	7707174000319	7707174000419	7707174000919	50
	10,27	10,27	10,27	11,90	

## EUCLIDE

ALLUMINIO GALATTICO

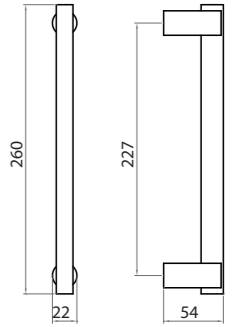

	MERCURY	URANUS	JUPITER	SPACE	Conf. Pz.
MAN DIR Maniglione diritto Straight pull handle	77056600233	77056600234	77056600241	77056600276	1
	40,25 ⚡	40,25 ⚡	40,25 ⚡	40,25 ⚡	

⚡ Servizio G48: Articolo a magazzino e disponibile entro 48 dall'elaborazione dell'ordine. In base a disponibilita' e condizioni di vendita.  
G48 service: Item in stock and available within 48 hours of order processing. Based on availability and sales conditions.

## 7009

ALLUMINIO

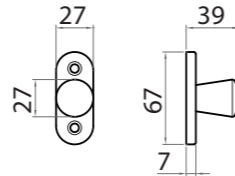

	F1	F3	F4	F9	Conf. Pz.
POM FISSO ROVV 7009/D ROVV FISSO fixed knob on 27x67 rose	77009735301	77009735303	77009735304	77009735309	50
	4,91	4,91	4,91	5,65	

## 7900

ALLUMINIO GALATTICO

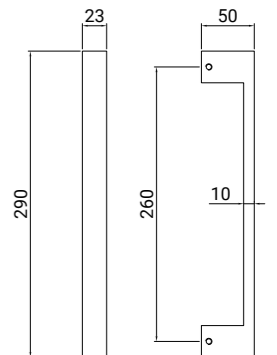

	MERCURY	URANUS	JUPITER	SPACE	Conf. Pz.
MAN DIR Maniglione diritto Straight pull handle	77900600233	77900600234	77900600241	77900600276	1
	44,56 ⚡	44,56 ⚡	44,56 ⚡	44,56 ⚡	

⚡ Servizio G48: Articolo a magazzino e disponibile entro 48 dall'elaborazione dell'ordine. In base a disponibilita' e condizioni di vendita.  
G48 service: Item in stock and available within 48 hours of order processing. Based on availability and sales conditions.



Per istruzioni di montaggio scansiona QR code, seleziona il numero di riferimento e segui le istruzioni.  
For assembly instructions scan the QR code, select the relevant assembly number and follow the instructions.



## AIRONE

OTTONE

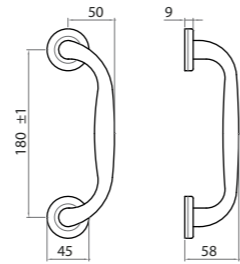

	OLV	OCS	OCL	ONS	Conf. Pz.
MAN ZAN R	55040612001	55040612003	55040612007	55040612027	1
Maniglione zancato su rosetta offset pull handle on rose	52,82	58,92	58,92	63,09	

## COMETA

OTTONE

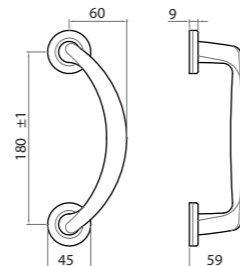

	OLV	OCS	OCL	ONS	Conf. Pz.
MAN ZAN R	55034612001	55034612003	55034612007	55034612027	1
Maniglione zancato su rosetta offset pull handle on rose	52,82	60,51	58,92	63,09	

## YORK DRITTO

ZAMA

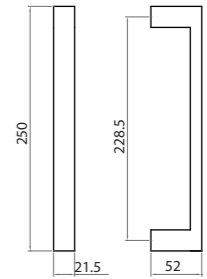

	ZCL	ZCS	ZNO	Conf. Pz.
MAN DIR	66460600207	66460600213	66460600216	1
Maniglione dritto Straight pull handle	46,87	46,87	43,66	
MAN DIR VET	66460606007	66460606013	66460606016	1
Coppia maniglioni dritti per vetro Straight pull handle for glass	91,36	91,36	85,10	
MAN DIR L/A	66460607007	66460607013	66460607016	1
Coppia maniglioni dritti per legno/alluminio Straight pull handle for alu / wood	91,36	91,36	85,10	

## YORK ZANCATO

ZAMA

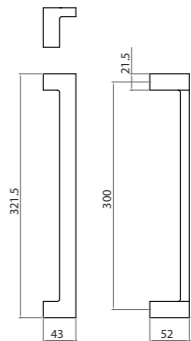

	ZCL	ZCS	ZNO	Conf. Pz.
MAN ZAN	66460610207	66460610213	66460610216	1
Maniglione zancato Offset pull handle	84,37	66,22	50,16	
MAN ZAN VET	66460616007	66460616013	66460616016	1
Coppia maniglioni zancati per vetro Pair of offset pull handle for glass	165,32	114,72	97,64	
MAN ZAN L/A	66460617007	66460617013	66460617016	1
Coppia maniglioni zancati per legno/alluminio Pair of pull handle for alu/wood	165,32	114,72	97,64	

# SOGNO

ZAMA

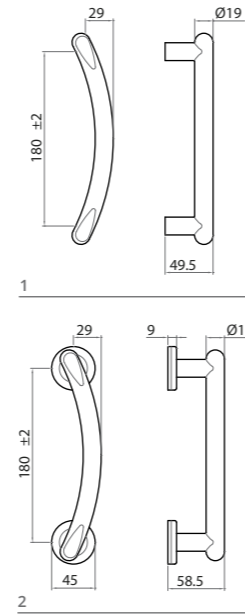

	ZCL	GCTOL	ZCS	ZNO	ZNS	Conf. Pz.
MAN ZAN S/R Maniglione zancato senza rosetta offset pull handle without rose	66096610107	66096610112	66096610113	66096610116	66096610127	1
	32,29	32,29	32,29	32,29	35,41	
MAN ZAN VET S/R Coppia maniglioni zancati per vetro senza rosetta Staight pull handle for glass without roses	66096616107	66096616112	66096616113	66096616116	66096616127	1
	64,58	64,58	64,58	64,58	70,83	
MAN ZAN L/A S/R Coppia maniglioni zancati per legno/alluminio senza rosetta Staight pull handle for alu/wood without roses	66096617107	66096617112	66096617113	66096617116	66096617127	1
	64,58	64,58	64,58	64,58	70,83	
MAN ZAN R Maniglione zancato su rosetta offset pull handle on rose	66096612007	66096612012	66096612013	66096612016	66096612027	1
	66,07	52,38	68,75	52,38	69,94	

# MODULARE

ZAMA



A	B
1700	1200
1000	800
500	300
400	300

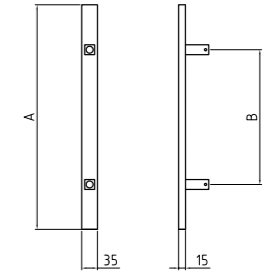

	F1-SAT	Conf. Pz.
MAN DIR Maniglione diritto Q 170 CM interasse ancoraggio cm 120 Staight pull handle	77070017033	1
	168,03	
MAN DIR Maniglione diritto Q 100 CM interasse ancoraggio cm 80 Staight pull handle	77070010033	1
	137,88	
MAN DIR Maniglione diritto Q 50 CM interasse ancoraggio cm 30 Staight pull handle	77070005033	1
	116,32	
MAN DIR Maniglione diritto Q 40 CM interasse ancoraggio cm 30 Staight pull handle	77070004033	1
	111,95	

# EUCLIDE

ZAMA

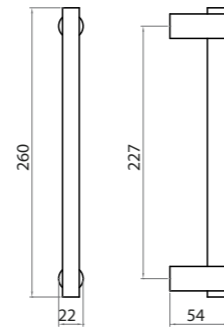

	OCL/F1-SAT	Conf. Pz.
MAN DIR Maniglione diritto Staight pull handle	77056600254	1
	37,94	
MAN DIR VET Coppia maniglioni diritti per vetro Staight pull handle for glass	77056606054	1
	75,29	
MAN DIR L/A Coppia maniglioni diritti per legno/alluminio Staight pull handle for alu / wood	77056607054	1
	75,29	

# ANELLO

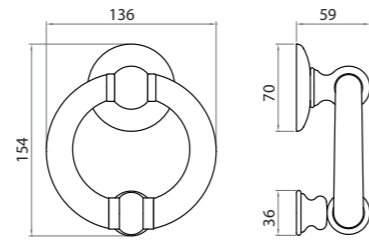

	OLV	OCS	OGV	OLD	OFA	Conf. Pz.
BATTENTE ANELLO	55748200001	55748200003	55748200004	55748200028	55748200029	
Battente ad anello	164,98	210,17	164,98	164,98	210,17	1
Door knocker						

# LEONE

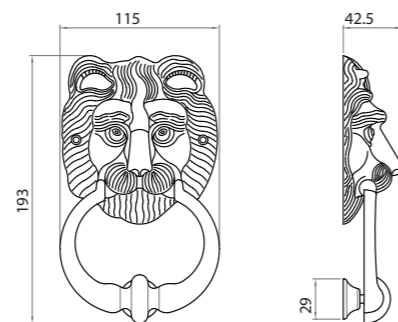

	OLV	OGV	Conf. Pz.
BATTENTE LEONE	55098218001	55098218004	
Battente Leone	57,29	57,29	1
Door knocker			

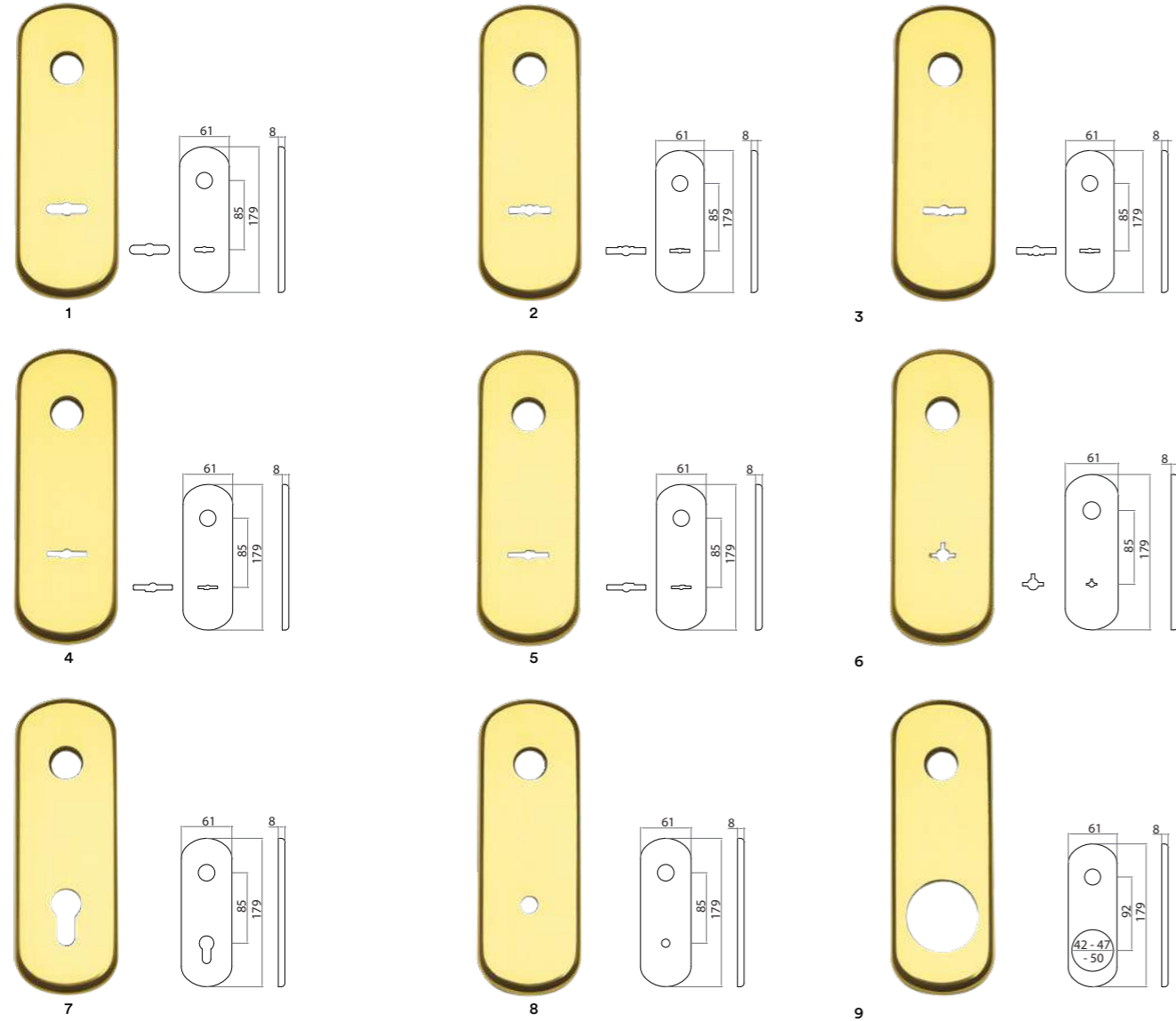

	F1	F4	GCTOL	GCTOS	GCTCL	GCTCS	Conf. Pz.
PL DM/UNIV 85 Placca doppia mappa universale interasse 85 universal double plate for safety lock 85mm	77298852001	77298852004	77298852012	77298852023	77298852024	77298852025	10
PL DM INT 85 Placca doppia mappa interna interasse 85 internal double plate for safety lock 85mm	77298852301	77298852304	77298852312	77298852323	77298852324	77298852325	10
PL DM EST 85 Placca doppia mappa esterna interasse 85 external double plate for safety lock 85mm	77298852401	77298852404	77298852412	77298852423	77298852424	77298852425	10
PL DM/A 85 DX Placca doppia mappa Atra interasse 85 destra double plate for safety lock 85mm right	77298852101	77298852104	77298852112	77298852123	77298852124	77298852125	10
PL DM/A 85 SX Placca doppia mappa Atra interasse 85 sinistra double plate for safety lock 85mm left	77298852201	77298852204	77298852212	77298852223	77298852224	77298852225	10
PL OMEGA Placca OMEGA plate Omega	77298852901	77298852904	77298852912	77298852923	77298852924	77298852925	10
PY85 Placca yale interasse 85 plate with cyl. hole 85mm	77298855001	77298855004	77298855012	77298855023	77298855024	77298855025	10
PL F10 Placca foro D.10 per cilindro con pomolo int 85 plate with 10mm cyl. hole with knob 85mm	77298858101	77298858104	77298858112	77298858123	77298858124	77298858125	10
PL DEF42 Placca Defender D.42 plate for cylinder protection 42mm	77298856501	77298856504	77298856512	77298856523	77298856524	77298856525	10
PL DEF47 Placca Defender D.47 plate for cylinder protection 47mm	77298856701	77298856704	77298856712	77298856723	77298856724	77298856725	10
PL DEF50 Placca Defender D.50 plate for cylinder protection 50mm	77298856601	77298856604	77298856612	77298856623	77298856624	77298856625	10

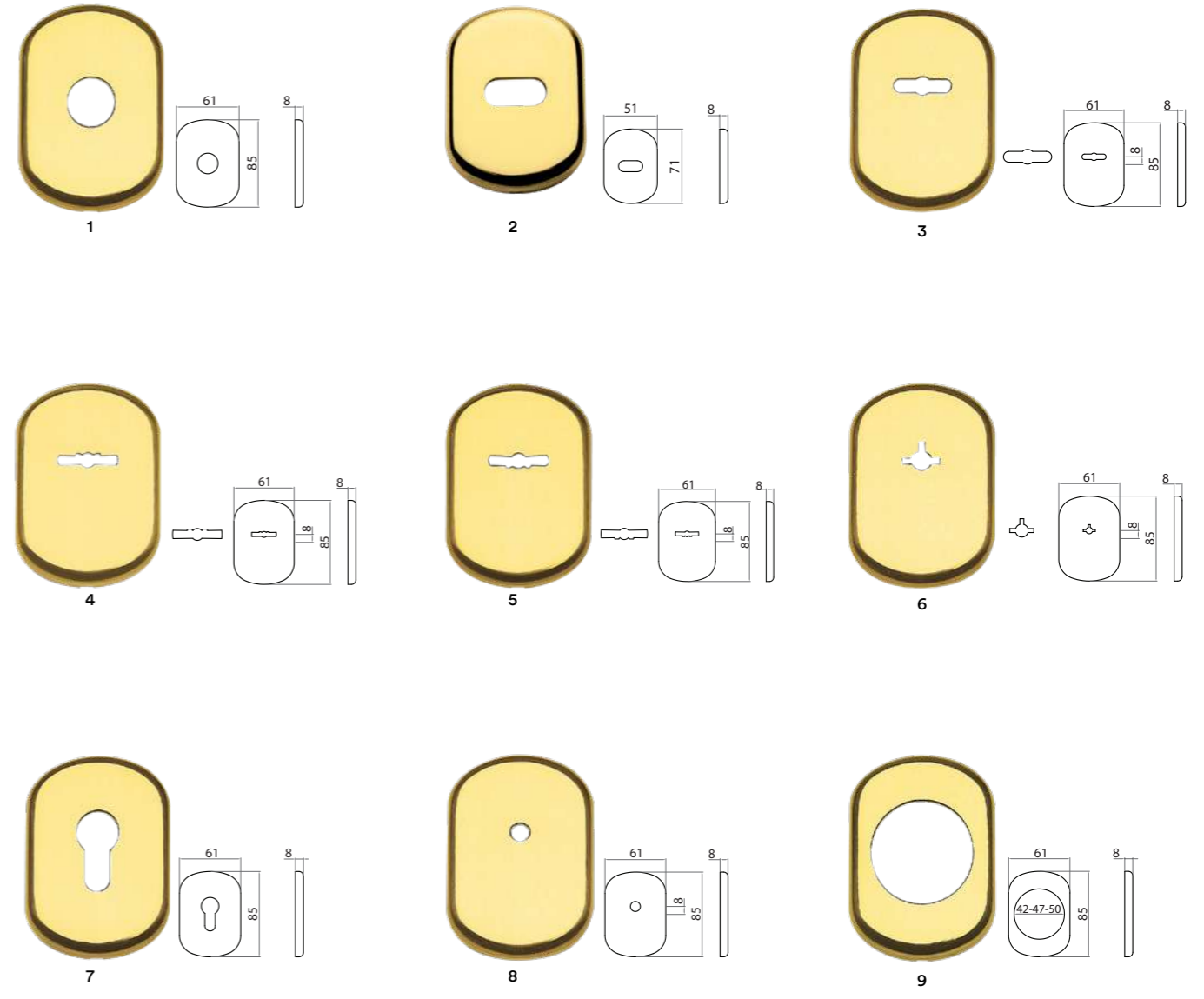

	F1	F4	GCTOL	GCTOS	GCTCL	GCTCS	Conf. Pz.
ROS 62x86 F20 GHIBLI ROS 62X86 F20 Rose mm.62X86 with round hole diam. 20	77298521001	77298521004	77298521012	77298521023	77298521024	77298521025	20
ROS 52x72 LIM/AP GHIBLI ROS 52X72 L/A Rose 52X72 for safety kit	77298599001	77298599004	77298599012	77298599023	77298599024	77298599025	20
BOC 62x86 DM/UNIV GHIBLI BOC 62X86 DMU Escutcheon 62X70	77298626001	77298626004	77298626012	77298626023	77298626024	77298626025	20
BOC 62x86 DM INT GHIBLI BOC 62X86 DMI Escutcheon 62X86	77298626301	77298626304	77298626312	77298626323	77298626324	77298626325	20
BOC 62x86 DM EST GHIBLI BOC 62X86 DME Escutcheon 62X86	77298626401	77298626404	77298626412	77298626423	77298626424	77298626425	20
BOC 62x86 OMEGA GHIBLI BOC 62X86 OMEGA Escutcheon 62X86 hole type omega	77298625901	77298625904	77298625912	77298625923	77298625924	77298625925	20
BOC 62x86 YALE GHIBLI BOC 62X86 YAL Escutcheon 62X86 cylinder key hole	77298625001	77298625004	77298625012	77298625023	77298625024	77298625025	20
BOC 62x86 F10 GHIBLI BOC 62X86 F10 Escutcheon 62X86 w/whole D.10	77298628101	77298628104	77298628112	77298628123	77298628124	77298628125	20
BOC 62x86 DEF42 GHIBLI BOC 62X86 D42 Escutcheon 62X86 hole diam. 42	77298626501	77298626504	77298626512	77298626523	77298626524	77298626525	20
BOC 62x86 DEF47 GHIBLI BOC 62X86 D47 Escutcheon 62X86 hole diam. 47	77298626701	77298626704	77298626712	77298626723	77298626724	77298626725	20
BOC 62x86 DEF50 GHIBLI BOC 62X86 D50 Escutcheon 62X86 hole diam. 50	77298626601	77298626604	77298626612	77298626623	77298626624	77298626625	20

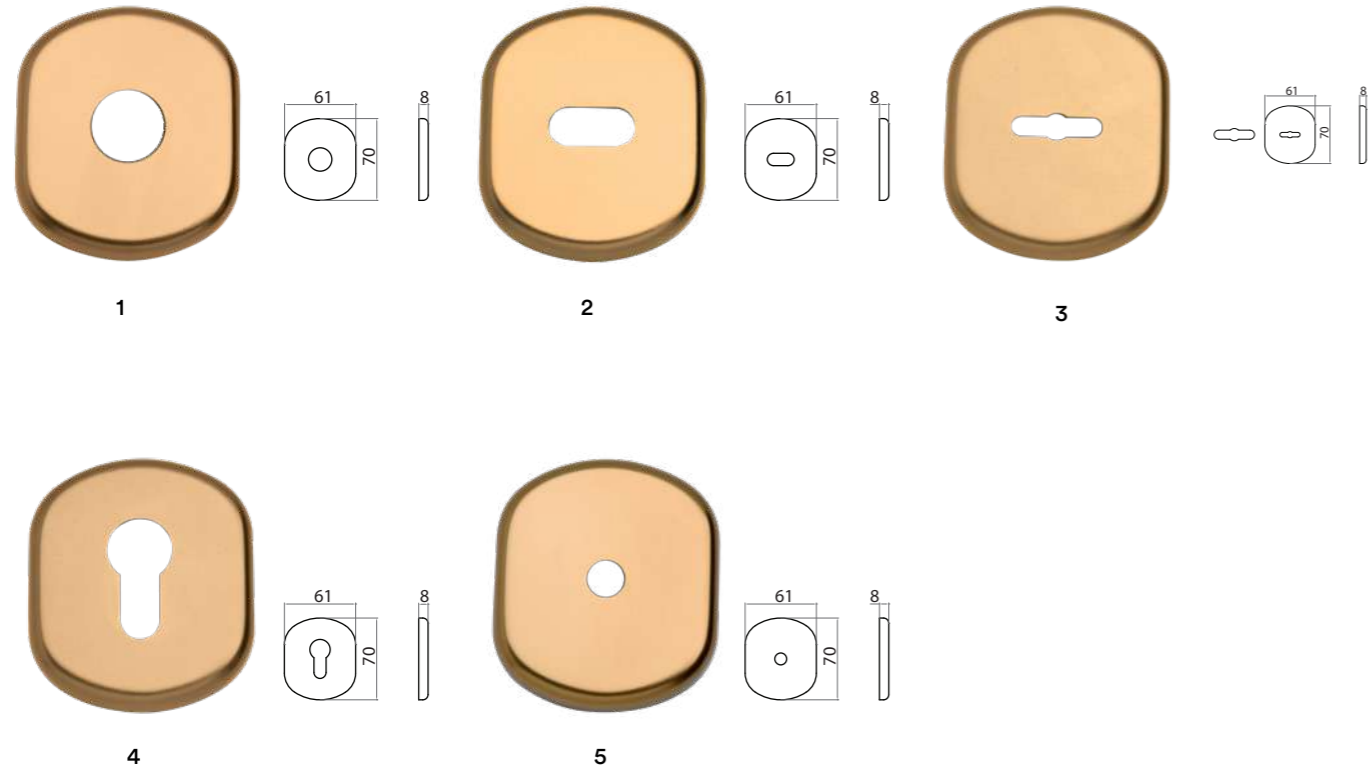

	F1	F4	GCTOL	GCTOS	GCTCL	GCTCS	Conf. Pz.
ROS 62x70 F.20	77198521001	77198521004	77198521012	77198521023	77198521024	77198521025	20
GHIBLI-2 ROS 62X70 F20 Rose 62X70 with round hole diam.20	3,27	3,27	5,06	6,40	5,06	6,40	
ROS 62x70 LIM/AP	77198599001	77198599004	77198599012	77198599023	77198599024	77198599025	20
GHIBLI-2 ROS 62X70 L/A Rose 62X70 for safety kit	3,27	3,27	5,06	6,40	5,06	6,40	
BOC 62x70 DM/UNIV	77198626001	77198626004	77198626012	77198626023	77198626024	77198626025	20
GHIBLI-2 BOC 62X70 DMU Escutcheon 62X70	3,27	3,27	5,06	6,40	5,06	6,40	
BOC 62x70 YALE	77198625001	77198625004	77198625012	77198625023	77198625024	77198625025	20
GHIBLI-2 BOC 62X70 YAL Cyl key escutcheon 62X70	3,27	3,27	5,06	6,40	5,06	6,40	
BOC 62x70 F10	77198628101	77198628104	77198628112	77198628123	77198628124	77198628125	20
GHIBLI-2 BOC 62X70 F10 Escutcheon 62X70	3,27	3,27	5,06	6,40	5,06	6,40	

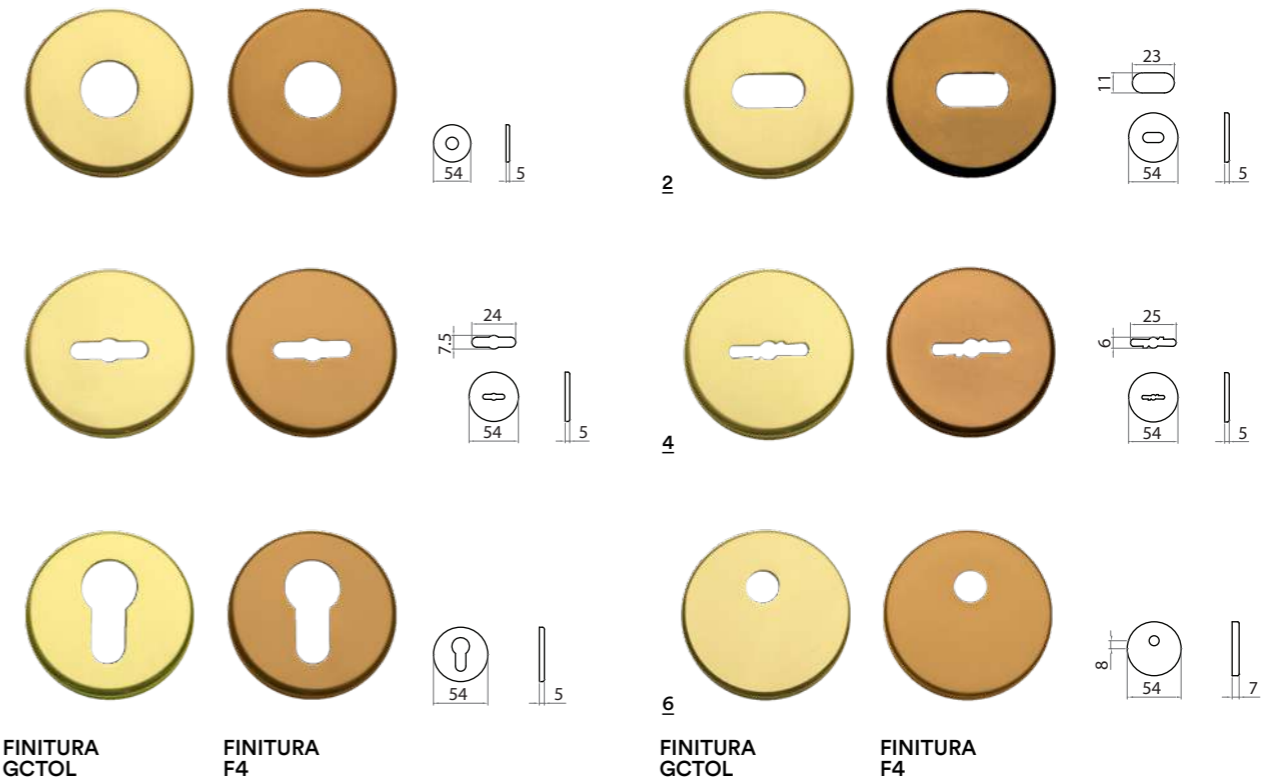

	F1	F4	GCTOL	GCTOS	GCTCL	GCTCS	Conf. Pz.
ROS. D54x5 F/18	77048501501	77048501504	77048501512	77048501523	77048501524	77048501525	20
Rosetta mm 54x5 foro diametro mm 18 Rose mm 54X5 with hole diam. 18mm	3,05	3,05	6,10	6,99	6,10	6,99	
ROS. D54X5 L/A	77048599201	77048599204	77048599212	77048599223	77048599224	77048599225	20
Rosetta mm 54x5 per limitatore apertura Rose mm 54X5 for safety kit	3,05	3,05	6,10	6,99	6,10	6,99	
BOCC. D54x5 DM UNIV. INT.	77048637301	77048637304	77048637312	77048637323	77048637324	77048637325	20
Bocchetta mm 54x5 doppia mappa universale interna (con copr Inside escutcheon 54x5 for safety lock	3,05	3,05	6,10	6,99	6,10	6,99	
BOCC. D54x5 DM UNIV. EST.	77048637401	77048637404	77048637412	77048637423	77048637424	77048637425	20
Bocchetta mm 54x5 doppia mappa universale esterna Outside escutcheon 54x5 for safety lock	3,05	3,05	6,10	6,99	6,10	6,99	
BOCC. D54x5 DM/5 INT.	77048637501	77048637504	77048637512	77048637523	77048637524	77048637525	20
Bocchetta mm 54x5 doppia mappa tipo 5 (Mottura) interna (con Inside escutcheon 54x5 for safety lock	3,05	3,05	6,10	6,99	6,10	6,99	
BOCC. D54x5 DM/5 EST.	77048637601	77048637604	77048637612	77048637623	77048637624	77048637625	20
Bocchetta mm 54x5 doppia mappa tipo 5 (Mottura) esterna Outside escutcheon 54x5 for safety lock	3,05	3,05	6,10	6,99	6,10	6,99	
BOCC. D54x5 YALE	77048635201	77048635204	77048635212	77048635223	77048635224	77048635225	20
Bocchetta mm 54x5 foro Yale Escutcheon 54x5 cyl. hole	3,05	3,05	6,10	6,99	6,10	6,99	
ROS. 54x7 F10SP	77048540001	77048540004	77048540012	77048540023	77048540024	77048540025	20
Rosetta mm 54x7 foro diametro mm 10 spostato Rose mm 54X7 with hole diam. 10mm	3,05	3,05	6,10	6,99	6,10	6,99	

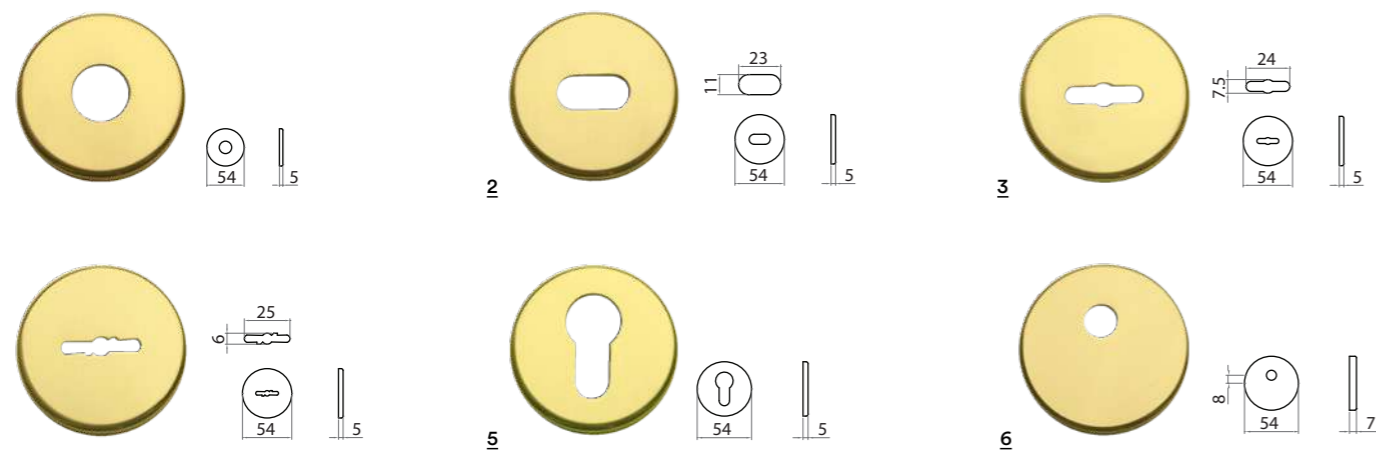

	OLV	OCS	OGV	OCL	OS	Conf. Pz.
ROS. D54x5 F/18 Rosetta mm 54x5 foro diametro mm 18 Rose mm 54x5 with hole diam. 18mm	55748501501	55748501503	55748501504	55748501507	55748501508	20
ROS. D54X5 L/A Rosetta mm 54x5 per limitatore apertura Rose mm 54x5 for safety kit	55748599201	55748599203	55748599204	55748599207	55748599208	20
BOCC. D54x5 DM UNIV. INT. Bocchetta mm 54x5 doppia mappa universale interna (con copril) Inside escutcheon 54x5 for safety lock	55748637301	55748637303	55748637304	55748637307	55748637308	20
BOCC. D54x5 DM UNIV. EST. Bocchetta mm 54x5 doppia mappa universale esterna Outside escutcheon 54x5 for safety lock	55748637401	55748637403	55748637404	55748637407	55748637408	20
BOCC. D54x5 DM/5 INT. Bocchetta mm 54x5 doppia mappa tipo 5 (Mottura) interna (con ) Inside escutcheon 54x5 for safety lock	55748637501	55748637503	55748637504	55748637507	55748637508	20
BOCC. D54x5 DM/5 EST. Bocchetta mm 54x5 doppia mappa tipo 5 (Mottura) esterna Outside escutcheon 54x5 for safety lock	55748637601	55748637603	55748637604	55748637607	55748637608	20
BOCC. D54x5 YALE Bocchetta mm 54x5 foro Yale Escutcheon 54x5 cyl. hole	55748635201	55748635203	55748635204	55748635207	55748635208	20
ROS. 54x7 F10SP Rosetta mm 54x7 foro diametro mm 10 spostato Rose mm 54x7 with hole diam. 10mm	55748540001	55748540003	55748540004	55748540007	55748540008	20

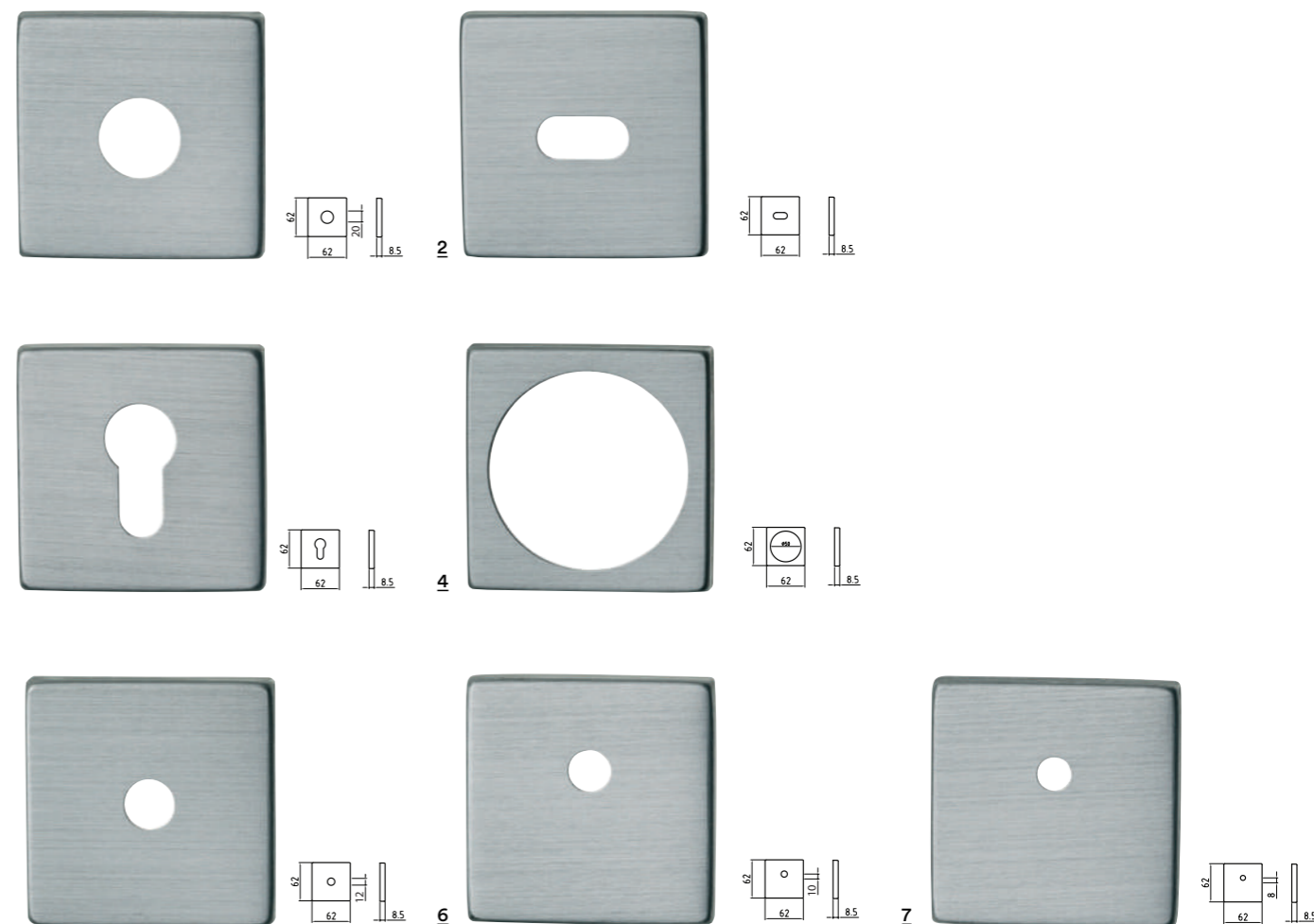

	F1	F4	GCTCL	F1-SAT	Conf. Pz.
ROS Q62x62X8,5 F20 BLINDO ROS Q 62X62X8,5 F.20 Square rose mm.62X62x8,5 with round hole diam. 20	77196572001	77196572004	77196572024	77196572033	20
ROS Q62x62X8,5 LIM/AP BLINDO ROS Q 62x62x8,5 L/A Square rose mm.62X62x8,5 for safety kit	77196599001	77196599004	77196599024	77196599033	20
BOC Q62x62X8,5 YALE BLINDO BOC Q 62x62x8,5 YAL Square escutcheon mm.62X62x8,5 cylinder key hole	77196625001	77196625004	77196625024	77196625033	20
BOC Q62x62X8,5 DEF50 BLINDO BOC Q 62x62x8,5 D50 Escutcheon 62X86 hole diam. 50	77196626601	77196626604	77196626624	77196626633	20
BOC Q62x62X8,5 F12 centrale BLINDO BOC Q 62x62x8,5 F12 centrale Escutcheon 62X86 hole diam. 12	77196572201	77196572204	77196572224	77196572233	20
BOC Q62x62X8,5 F10 SP BLINDO BOC Q 62x62x8,5 F10 Square escutcheon mm.62X62x8,5 D.10	77196572101	77196572104	77196572124	77196572133	20
BOC Q62x62X8,5 F8 SP BLINDO BOC Q 62x62x8,5 F8 SP Escutcheon 62X86 hole diam. 8	77196572801	77196572804	77196572824	77196572833	20

# UNO

OTTONE

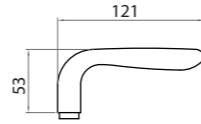

	OLV	OCS	OGV	OCL	OS	Conf. Pz.
IM Q8 GM6TE	55796012301	55796012303	55796012304	55796012307	55796012308	10
UNO IM Q8 VB G6T	12,20	13,24	12,20	13,24	12,20	
Lever handle 8mm with grub screw M6 visible						

# SUSY

ALLUMINIO

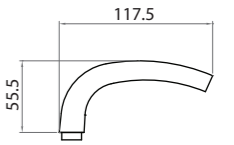
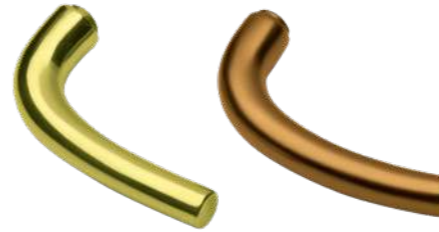

	F1	F4	GCTOL	GCTOS	GCTCL	GCTCS	Conf. Pz.
IM Q8 GM6TE	77434018301	77434018304	77434018312	77434018323	77434018324	77434018325	10
SUSY IM Q8 G6T	7,14	7,14	8,48	10,56	8,48	10,56	
Lever handle 8mm with grub screw M6 visible							

# MILENA Z

ZAMA

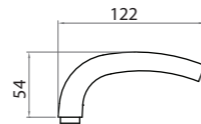

	ZGV	ZCL	GCTOL	ZCS	Conf. Pz.
IM Q8 GM6TE	66744012304	66744012307	66744012312	66744012313	10
MILENA-Z IM Q8 GM6TE	10,42	11,46	10,42	11,46	
Lever handle 8mm with grub screw M6 visible					

# BRIXIA

ALLUMINIO

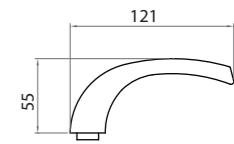

	F1	F4	GCTOL	GCTOS	GCTCL	GCTCS	Conf. Pz.
IM Q8 GM6TE	77438018301	77438018304	77438018312	77438018323	77438018324	77438018325	10
BRIXIA Q8 IM G6T	7,44	7,44	8,78	10,86	8,78	10,86	
Lever handle 8mm with grub screw M6 visible							

# GM05

ZAMA

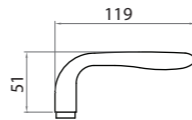

	ZGV	ZCL	GCTOL	ZCS	Conf. Pz.
IM Q8 GM6TE	6GM58012304	6GM58012307	6GM58012312	6GM58012313	10
GM05-Z IM Q8 GM6TE	9,37	10,42	9,37	10,42	
Lever handle 8mm with grub screw M6 visible					

## BLINDO

OTTONE

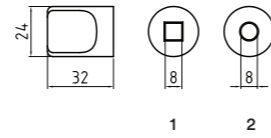

	OLV	OCS	OCL	Conf. Pz.
1 POM Q8 S/ROS BLINDO POM Q8 IM *	55698228301	55698228303	55698228307	10
knob 8mm w/o rose	12,30	13,22	13,88	
2 POM F.8 S/ROS BLINDO POM F8 S/V *	55698228701	55698228703	55698228707	10
knob w/o rose 8mm hole	12,30	13,22	13,88	

## MEZZALUNA

ZAMA

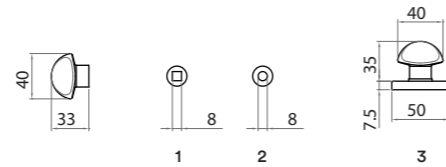

	ZGV	ZCL	GCTOL	ZCS	GCTOS	Conf. Pz.
1 POM Q8 S/ROS MEZZALUNA POM Q8 IM	66748228504	66748228507	66748228512	66748228513	66748228523	10
knob 8mm w/o rose	7,42	7,20	7,37	7,09	6,64	
2 POM F.8 S/ROS MEZZALUNA POM F8 S/V	66748228704	66748228707	66748228712	66748228713	66748228723	10
knob w/o rose 8mm hole	7,42	7,20	7,37	7,09	6,64	
3 POM Q8 R50x7 Q8x80 MEZZALUNA POM Q8x80 R51x7	6674822850428	6674822850728	6674822851228	6674822851328	6674822852328	10
knob on rose 50x7 with spindle 8x80mm	12,11	12,72	12,05	12,22	12,05	

## UNIVERSAL

ALLUMINIO

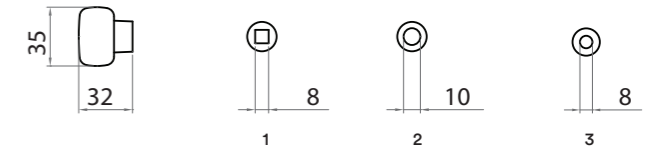

	F1	F4	GCTOL	GCTOS	GCTCL	GCTCS	Conf. Pz.
1 POM35 Q8 S/ROS Pomolo mm 35 Q8 senza rosetta	77486812701	77486812704	77486812712	77486812723	77486812724	77486812725	10
knob mm 35 spindle mm 8 without rose	5,95	5,95	7,89	10,12	7,89	10,12	
2 POM35 F.10 S/ROS Pomolo mm 35 foro mm 10 senza rosetta	77486817301	77486817304	77486817312	77486817323	77486817324	77486817325	10
knob mm 35 hole mm 10 without rose	5,95	5,95	7,89	10,12	7,89	10,12	
3 POM35 F.8 S/ROS Pomolo mm 35 foro mm 8 senza rosetta	77486816701	77486816704	77486816712	77486816723	77486816724	77486816725	10
knob mm 35 hole mm 8 without rose	5,95	5,95	7,89	10,12	7,89	10,12	

## MEZZALUNA

ALLUMINIO

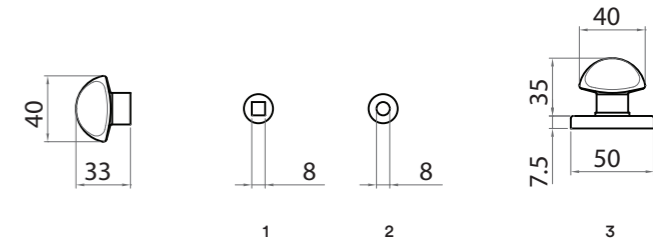

	F1	F4	Conf. Pz.
1 POM Q8 S/ROS MEZZALUNA POM Q8 IM *	77048228501	77048228504	10
knob 8mm w/o rose	3,94	3,94	
2 POM F.8 S/ROS MEZZALUNA POM F8 S/V *	77048228701	77048228704	10
knob w/o rose 8mm hole	3,94	3,94	
3 POM Q8 R50x7 Q8x80 MEZZALUNA POM Q8x80 R50x7	7704822850128	7704822850428	10
knob on rose 50x7 with spindle 8x80mm	9,23	9,23	



# SUSY

ALLUMINIO

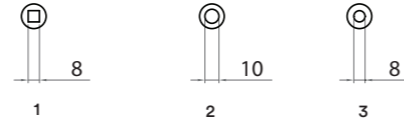
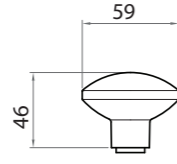

	F1	F4	GCTOL	GCTOS	GCTCL	GCTCS	Conf. Pz.
1 POM40 Q8 S/ROS Pomolo mm 40 Q8 senza rosetta knob mm 40 spindle mm 8 without rose	77434822701 6,70	77434822704 6,70	77434822712 8,63	77434822723 11,01	77434822724 8,63	77434822725 11,01	10
2 POM40 F.10 S/ROS Pomolo mm 40 foro mm 10 senza rosetta knob mm 40 hole mm 10 without rose	77434827301 6,70	77434827304 6,70	77434827312 8,63	77434827323 11,01	77434827324 8,63	77434827325 11,01	10
3 POM40 F.8 S/ROS Pomolo mm 40 foro mm 8 senza rosetta knob mm 40 hole mm 8 without rose	77434816701 6,70	77434816704 6,70	77434816712 8,63	77434816723 11,01	77434816724 8,63	77434816725 11,01	10

# BLINDO

ALLUMINIO

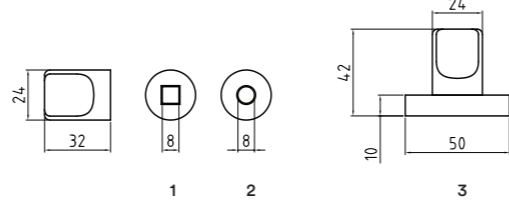

	F1	F4	GCTOL	GCTCL	F1-SAT	Conf. Pz.
1 POM Q8 S/ROS BLINDO POM Q8 IM *	77194228301 8,03	77194228304 8,03	77194228312 11,85	77194228324 11,85	77194228333 9,71	10
2 POM F.8 S/ROS BLINDO POM F8 S/V *	77194228701 8,03	77194228704 8,03	77194228712 11,85	77194228724 11,85	77194228733 9,71	10
3 POM Q8 RQ50x7 Q8x80 BLINDO POM Q8x80 RQ50x7 knob on square rose 50x7 with spindle 8x80mm	77194228501 12,25	77194228504 12,25	77194228512 17,13	77194228524 17,13	77194228533 15,35	10

# KIT BASCULANTE/GARAGE DOORS KIT

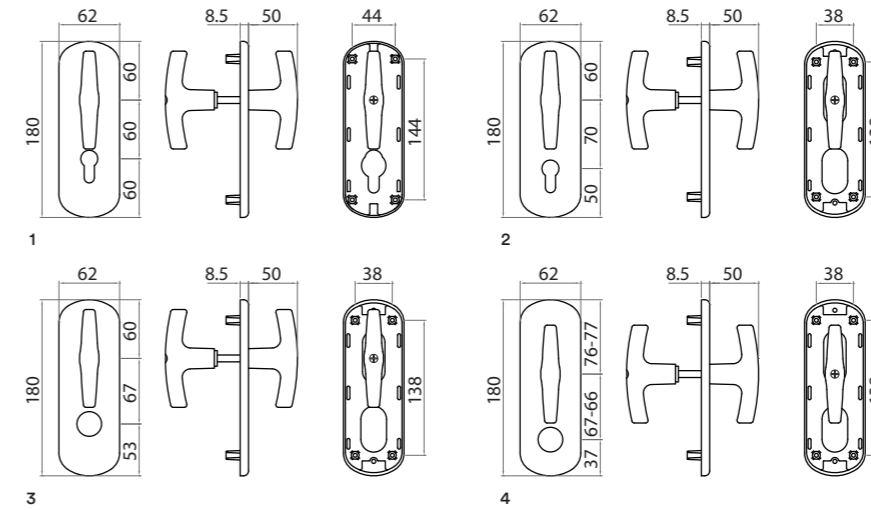

	F1	F4	GCTOL	GCTOS	GCTCL	GCTCS	Conf. Pz.
1 KIT BASCULANTE YALE 60 Kit per basculante yale 60 Garage door kit	77400517001 25,59	77400517004 25,59	77400517012 39,43	77400517023 45,38	77400517024 39,43	77400517025 45,38	1
2 KIT BASCULANTE YALE 70 Kit per basculante yale 70 Garage door kit	77400517501 25,59	77400517504 25,59	77400517512 39,43	77400517523 45,38	77400517524 39,43	77400517525 45,38	1
3 KIT BASCULANTE CIL D25 INT67 Kit per basculante foro cilindro D.25 int.67 Garage door kit	77400518001 25,59	77400518004 25,59	77400518012 39,43	77400518023 45,38	77400518024 39,43	77400518025 45,38	1
4 KIT BASCULANTE CIL D25 INT67 SP Kit per basculante foro cilindro D.25 int.67 spostato Garage door kit	77400518501 25,59	77400518504 25,59	77400518512 39,43	77400518523 45,38	77400518524 39,43	77400518525 45,38	1

# 8

## Acciaio Inox

## Stainless steel

438 Maniglie + dk / Handles + dk  
442 Accessori / Accessories  
443 Maniglioni fissi / Pull handles



L'acciaio è una lega di ferro contenente carbonio fino a circa il 2% ed altri elementi che conferiscono al metallo determinate caratteristiche. In base al loro impiego gli acciai vengono comunemente divisi in acciai di uso generale e acciai speciali. Gli acciai inossidabili (inox) appartengono a questa seconda categoria ed hanno resistenza all'ossidazione ed alla corrosione, caratteristiche determinate dalla presenza in lega di nichel e cromo.

Steel is an iron alloy containing up to 2% carbon and other elements which give the metal certain characteristics. Steels are commonly divided into steels for general use and steels for specific uses according to their final use. Stainless steels belong to the second category and resist oxidation and corrosion, a characteristic which is determined by the presence of nickel and chrome in the alloy.

# STEEL 1



	INOX	Conf. Pz.
1 Q8 R Guarnitura Q8 ros. senza bocc. Lever handle 8mm on rose	99546280055 48,21	1
1 Q8 RB Guarnitura Q8 ros./bocc. patent Lever handle 8mm on rose key hole escutcheon	99546281055 63,98	1
1 Q8 RBY Guarnitura Q8 ros./bocc. yale Lever handle 8mm on rose - cyl. hole escutcheon	99546285055 63,98	1
1 Q8 RBWC Guarnitura Q8 ros./bocc. Wc Lever handle 8mm on rose wc hole escutcheon	99546288055 88,54	1
2 Q8 ROC Guarnitura Q8 ros.ovale senza bocc. Lever handle 8mm on oval rose	99546220555 48,21	1
2 Q8 RBOYC Guarnitura Q8 ros/boc. ovale Yale Lever handle 8mm on oval rose - cyl. hole escutcheon	99546225555 63,98	1
3 DK X 40 Martellina DK Q7 x 40 window handle DK x 40 mm	99546557055 45,83	2
3 DK X 40 C/BUSS. Martellina DK Q7 x 40 con bussole D. 9,5 window handle DK x 40mm with pins D.9,5	99546558055 45,83	2

## PORTA

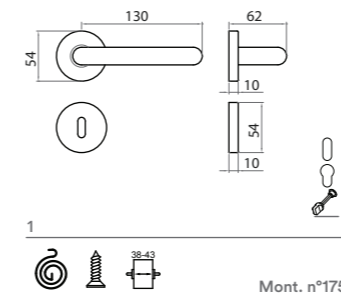

## FINESTRA

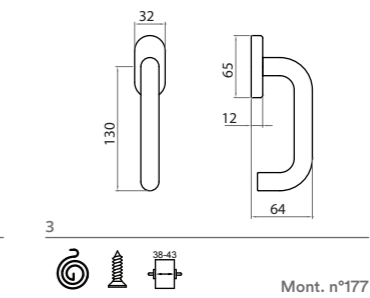

Guarnitura con sottorosetta in Nylon,  
disponibile a richiesta con sottorosetta in acciaio,  
viti passanti, grano in testa e molla di richiamo.  
Guarnitura con rosetta ovale coprivite  
fornita con molla ambidestra.

Seal with nylon rose,  
also available in stainless steel,  
connection and components.  
Seal with oval screw-covering rose  
provided with ambidextrous spring.



Per istruzioni di montaggio  
scansiona QR code,  
seleziona il numero di  
riferimento e segui le  
istruzioni.  
For assembly instructions  
scan the QR code, select the  
relevant assembly number  
and follow the instructions.

# STEEL 1 L



	INOX	Conf. Pz.
1 Q8 R Guarnitura Q8 ros. senza bocc. Lever handle 8mm on rose	99544280055 111,45	1
1 Q8 RB Guarnitura Q8 ros./bocc. patent Lever handle 8mm on rose key hole escutcheon	99544281055 127,22	1
1 Q8 RBY Guarnitura Q8 ros./bocc. yale Lever handle 8mm on rose - cyl. hole escutcheon	99544285055 127,22	1
1 Q8 RBWC Guarnitura Q8 ros./bocc. Wc Lever handle 8mm on rose wc hole escutcheon	99544288055 151,78	1
2 Q8 ROC Guarnitura Q8 ros.ovale senza bocc. Lever handle 8mm on oval rose	99544220555 111,45	1
2 Q8 RBOYC Guarnitura Q8 ros/boc. ovale Yale Lever handle 8mm on oval rose - cyl. hole escutcheon	99544225555 127,22	1

## PORTA

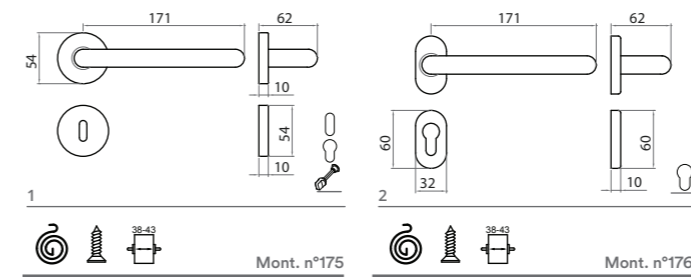

Guarnitura con sottorosetta in Acciaio inox, viti passanti, grano in testa e molla di richiamo.  
Guarnitura con rosetta ovale coprivite fornita con molla ambidestra.

Seal with stainless steel rose connection and components.  
Seal with oval screw-covering rose provided with ambidextrous spring.



Per istruzioni di montaggio scansiona QR code, seleziona il numero di riferimento e segui le istruzioni.  
For assembly instructions scan the QR code, select the relevant assembly number and follow the instructions.

# BOCCHETTE

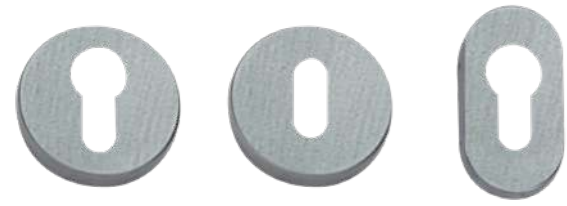

	INOX	Conf. Pz.
BOC PAT Bocchetta patent Round key escutcheon	99548631055 7,89	10
BOC YALE Bocchetta Yale Round cyl. Escutcheon	99548635055 7,89	10
BOV OVALE YALE Bocchetta ovale yale Oval escutcheon with cyl. hole	99548625055 7,89	10

# NOTTOLINO

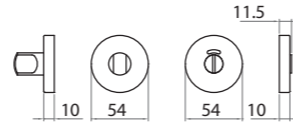

	INOX	Conf. Pz.
NOTT RWC Nottolino WC Q.6 con rosette d.50 M+F Toilet set - spindle 6 mm with rose	99548638055 43,30	10

# STEEL 101

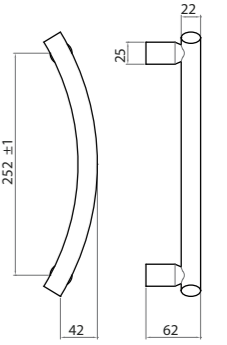

	INOX	Conf. Pz.
MAN ZAN STEEL 101 MAN ZAN Offset pull handle with accessories	99542601255 122,16	1

# STEEL 102

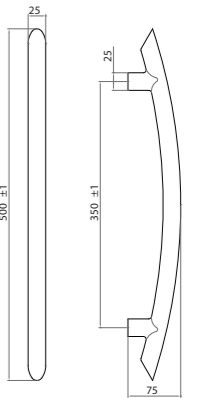

	INOX	Conf. Pz.
MAN DIR STEEL 102 MAN DIR Straight pull handle with accessories	99544600255 103,42	1
MAN DIR CP STEEL 102 MANCP DIR Pair of pull handle with accessories	99544600755 206,68	1

## STEEL 109

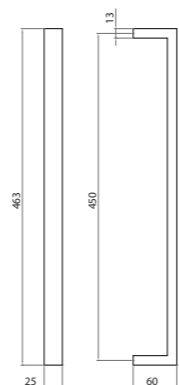

	INOX	Conf. Pz.
MAN DIR	99534600255	
STEEL 109 MAN DIR SINGOLO	115,17	1
Straight pull handle with accessories		
MAN DIR CP	99534600755	
STEEL 109 MANCP DIR	230,34	1
Pair of pull handle with accessories		

## STEEL 115

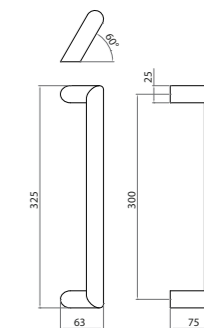

	INOX	Conf. Pz.
MAN ZAN DIR	99526610255	
Maniglione zancato dritto con fissaggi	90,62	1
Straight pull handle with accessories		
MAN ZAN CP DIR	99526610755	
Maniglioni zancati dritti accoppiati con fissaggi	181,24	1
paier of straight pull handle with accessories		

## STEEL 113

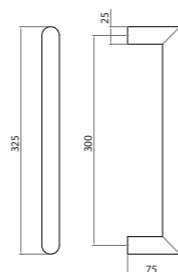

	INOX	Conf. Pz.
MAN DIR	99538600255	
Maniglione dritto completo di fissaggio	81,10	1
Straight pull handle with accessories		
MAN DIR CP	99538600755	
Maniglione dritto accoppiato completo di fissaggio	162,19	1
Pair of pull handle with accessories		

# 9

## Nylon

- 452 Maniglie / Handles
- 462 Accessori / Accessories
- 464 Maniglioni fissi / Pull handles
- 465 Pomoli / Knobs
- 466 Appendiabiti / Coat hangers
- 467 Copri avvolgibili / Plates for roller shutters



**Nylon é la denominazione commerciale della poliammide 6.6, resina termoplastica sintetica con elevate proprietà meccaniche e buona resistenza agli agenti chimici. Tutta la produzione in Nylon é ottenuta mediante stampaggio per iniezione.**

**Nylon is the trade name for 6.6 polyamide, a synthetic thermoplastic resin with high mechanical properties and strong resistance to chemical agents. All nylon products are made using injection presses.**

# Finiture Nylon Nylon finishing

Bianco / White 01  
Nero / Black 02



02



01

Handles

Maniglie

Nylon

Nylon

# MINNY

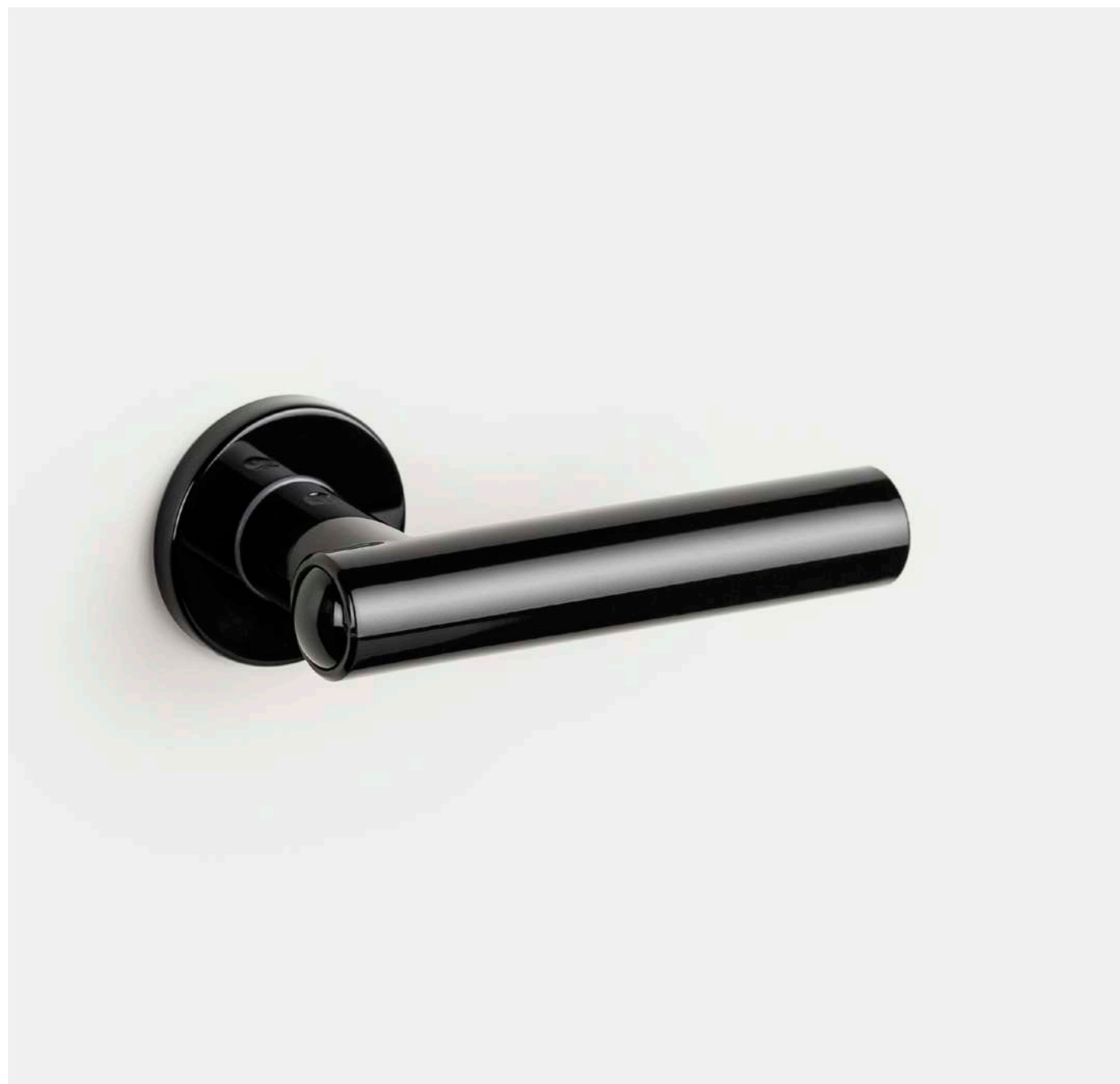

NGI      NGR      NAM      NRO

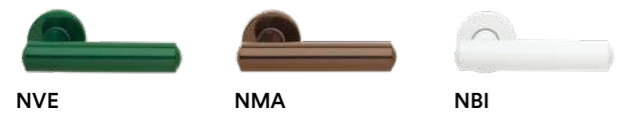

NVE      NMA      NBI

Colori disponibili a magazzino: nero, bianco.  
 Per tutti gli altri colori richiedere di volta in volta fattibilità e tempi di consegna. Tutte le versioni cremonesi e martellina sono realizzabili applicando a CREM/MART SG i giochi disponibili a pagina 139.

Storage colors available: black, white.  
 For all others colors ask feasibility and delivery times.

	NGI	NGR	NAM	NVE	Conf. Pz.
Q8 BIL Coppia maniglie con Q8 (Bilancino) Pair handle with 8mm spindle	88940208001 7,44	88940208002 7,44	88940208003 7,44	88940208004 7,44	8 8
CREM/MART SG Cremonese-martellina Q7 senza gioco Window handle without mechanism	88940400001 7,14	88940400002 7,14	88940400003 7,14	88940400004 7,14	10 10
	NNE	NMA	NBI	NRO	Conf. Pz.
Q8 BIL Coppia maniglie con Q8 (Bilancino) Pair handle with 8mm spindle	88940208005 6,24	88940208006 7,44	88940208007 6,24	88940208008 7,44	8 8
CREM/MART SG Cremonese-martellina Q7 senza gioco Window handle without mechanism	88940400005 7,14	88940400006 7,14	88940400007 7,14	88940400008 7,14	10 10

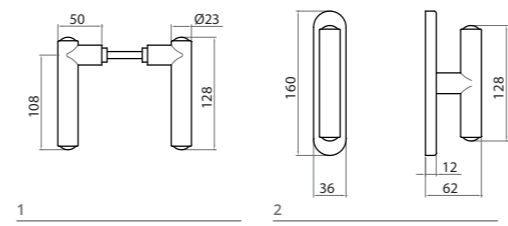

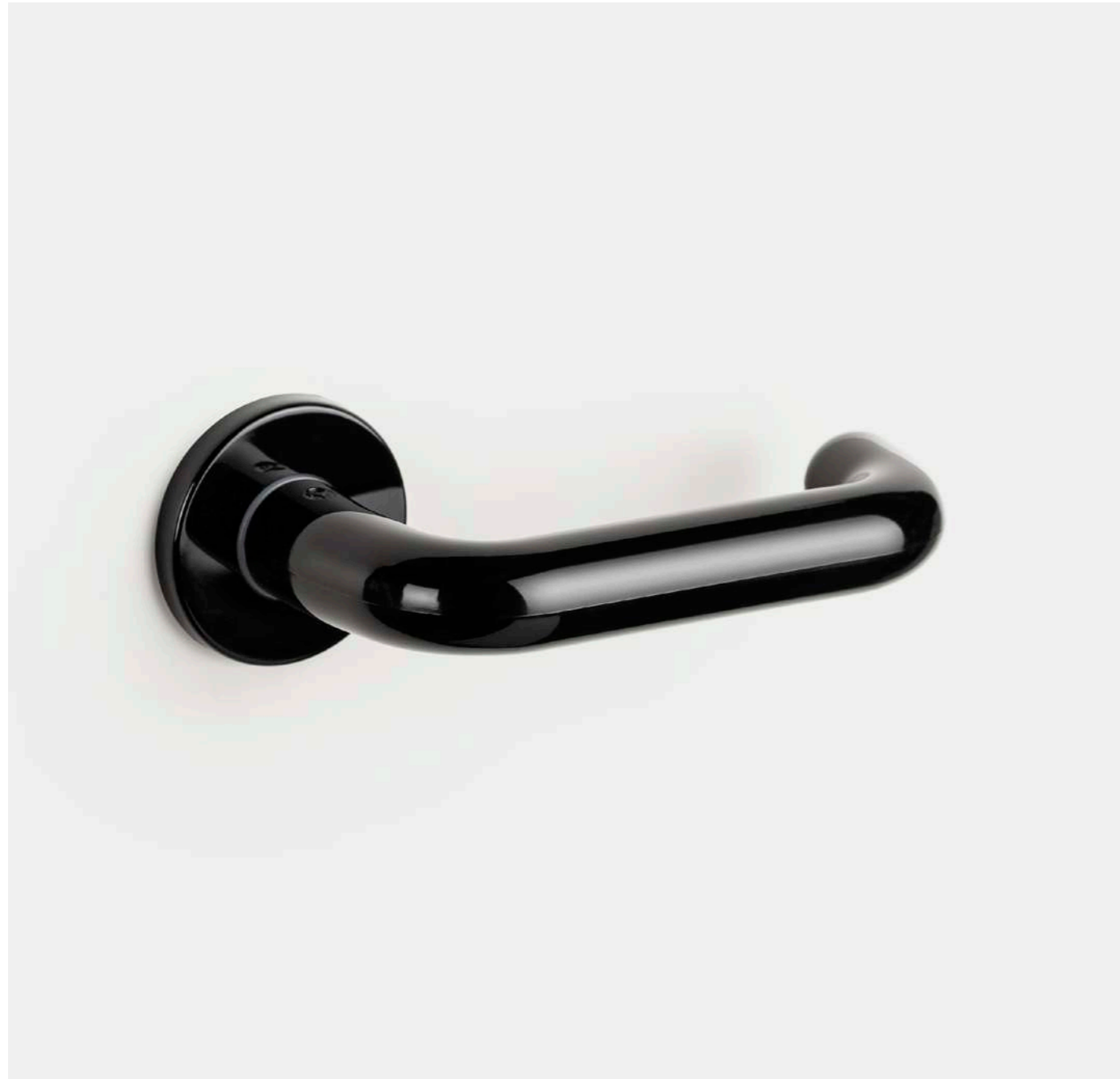

NGI



NGR



NAM



NVE



NMA



NBI



NRO

Colori disponibili a magazzino: nero, bianco.  
 Per tutti gli altri colori richiedere di volta in volta fattibilità e tempi di consegna. Tutte le versioni cremonesi e martellina sono realizzabili applicando a CREM/MART SG i giochi disponibili a pagina 139.

Storage colors available: black, white.  
 For all others colors ask feasibility and delivery times.  
 For all dk system it's possible to check systems at page 139.

	NGI	NGR	NAM	NVE	Conf. Pz.
Q8 BIL	88944208001	88944208002	88944208003	88944208004	
Coppia maniglie con Q8 (Bilancino)	9,52	9,52	9,52	9,52	8
Pair handle with 8mm spindle					
CREM/MART SG	88944400001	88944400002	88944400003	88944400004	
Cremonese-martellina Q7 senza gioco	8,18	8,18	8,18	8,18	10
Window handle without mechanism					
	NNE	NMA	NBI	NRO	Conf. Pz.
Q8 BIL	88944208005	88944208006	88944208007	88944208008	
Coppia maniglie con Q8 (Bilancino)	9,75	9,52	9,75	9,52	8
Pair handle with 8mm spindle					
CREM/MART SG	88944400005	88944400006	88944400007	88944400008	
Cremonese-martellina Q7 senza gioco	8,18	8,18	8,18	8,18	10
Window handle without mechanism					

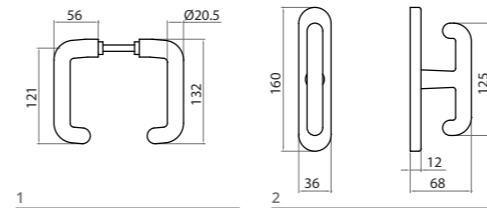

# ROMY

88934

Romy

Handles



88934

Romy

Maniglie



Colori disponibili a magazzino: nero, bianco.  
 Per tutti gli altri colori richiedere di volta in volta fattibilità e tempi di consegna. Tutte le versioni cremonesi e martellina sono realizzabili applicando a CREM/MART SG i giochi disponibili a pagina 139.

Storage colors available: black, white.  
 For all others colors ask feasibility and delivery times.  
 For all dk system it's possible to check systems at page 139.

	NGR	NNE	NBI	NRO	Conf. Pz.
Q8 BIL	88934208002	88934208005	88934208007	88934208008	8
Coppia maniglie con Q8 (Bilancino)	17,86	17,86	17,86	17,86	
Pair handle with 8mm spindle					

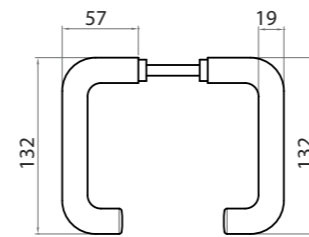



Guarnitura per il serramento in alluminio con doppia molla di ritorno ambidestra e doppio grano.

Alluminium seal with double return spring ambidextrous and double grub.

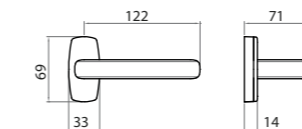

Q8 RRC  
Guarnitura Q8 rosetta rettangolare  
Lever handle 8mm on rectangular rose

NNE	Conf. Pz.
88894210005	6
16,81	



POM Q8 BIL  
 Coppia pomoli mm. 55 Q8  
 pair of knobs mm 55 8mm

	NNE	NBI	Conf. Pz.
	88944751905	88944751907	8
	15,48	15,48	

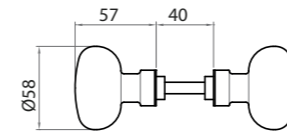

88944

Lia

Handles

Nylon

88944

Lia

Maniglie

Nylon

## MINNY



	NNE	NMA	NBI	NRO	Conf. Pz.
ROS TONDA Rosetta tonda round rose	88948531005 1,34	88948531006 1,79	88948531007 1,34	88948531008 1,79	16
BOC TONDA PAT Bocchetta tonda patent Round key escutcheon	88948631005 1,34	88948631006 1,79	88948631007 1,34	88948631008 1,79	16
BOC TONDA YALE Bocchetta tonda Yale Round cyl. Escutcheon	88948635005 1,34	88948635006 1,79	88948635007 1,34	88948635008 1,79	16

	NGI	NGR	NAM	NVE	Conf. Pz.
ROS TONDA Rosetta tonda round rose	88948531001 1,79	88948531002 1,79	88948531003 1,79	88948531004 1,79	16
BOC TONDA PAT Bocchetta tonda patent Round key escutcheon	88948631001 1,79	88948631002 1,79	88948631003 1,79	88948631004 1,79	16
BOC TONDA YALE Bocchetta tonda Yale Round cyl. Escutcheon	88948635001 1,79	88948635002 1,79	88948635003 1,79	88948635004 1,79	16

## MINNY

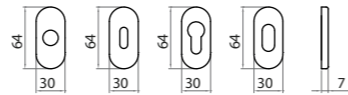

	NNE	NMA	NBI	NRO	Conf. Pz.
ROS OVALE Rosetta ovale oval rose	88948521005 1,34	88948521006 1,79	88948521007 1,34	88948521008 1,79	16
BOC OVALE PAT Bocchetta ovale patent Oval escutcheon with key hole	88948621005 1,79	88948621006 1,79	88948621007 1,79	88948621008 1,79	16
BOC OVALE YALE Bocchetta ovale Yale Oval escutcheon with cyl. hole	88948625005 1,34	88948625006 1,79	88948625007 1,34	88948625008 1,79	16
BOC OVALE F/O Bocchetta ovale foro cilindro ovale Oval escutcheon with cyl. hole	88948622005 1,79	88948622006 1,79	88948622007 1,79	88948622008 1,79	16

	NGI	NGR	NAM	NVE	Conf. Pz.
ROS OVALE Rosetta ovale oval rose	88948521001 1,79	88948521002 1,79	88948521003 1,79	88948521004 1,79	16
BOC OVALE PAT Bocchetta ovale patent Oval escutcheon with key hole	88948621001 1,79	88948621002 1,79	88948621003 1,79	88948621004 1,79	16
BOC OVALE YALE Bocchetta ovale Yale Oval escutcheon with cyl. hole	88948625001 1,79	88948625002 1,79	88948625003 1,79	88948625004 1,79	16
BOC OVALE F/O Bocchetta ovale foro cilindro ovale Oval escutcheon with cyl. hole	88948622001 1,79	88948622002 1,79	88948622003 1,79	88948622004 1,79	16

## MINNY

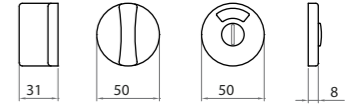

	NVE	NNE	NMA	NBI	NRO	Conf. Pz.
NOTT RWC Nottolino WC Q.6 con rosette Toilet set Q.6 with rose	88948638004 12,35	88948638005 12,35	88948638006 12,35	88948638007 12,35	88948638008 12,35	10

## MINNY

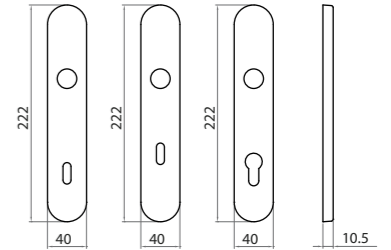

	NNE	NMA	NBI	NRO	Conf. Pz.
P90 Placca patent 90 plate with key hole 90mm	88948851005 3,42	88948851006 3,42	88948851007 3,42	88948851008 3,42	16
P70 Placca patent 70 plate with key hole 70mm	88948857005 3,42	88948857006 3,42	88948857007 3,42	88948857008 3,42	16
PY85 Placca Yale 85 plate with cyl. hole 85mm	88948855005 2,68	88948855006 3,42	88948855007 3,42	88948855008 3,42	16

	NGI	NGR	NAM	NVE	Conf. Pz.
P90 Placca patent 90 plate with key hole 90mm	88948851001 3,42	88948851002 3,42	88948851003 3,42	88948851004 3,42	16
P70 Placca patent 70 plate with key hole 70mm	88948857001 3,42	88948857002 3,42	88948857003 3,42	88948857004 3,42	16
PY85 Placca Yale 85 plate with cyl. hole 85mm	88948855001 3,42	88948855002 3,42	88948855003 3,42	88948855004 3,42	16



## MINNY

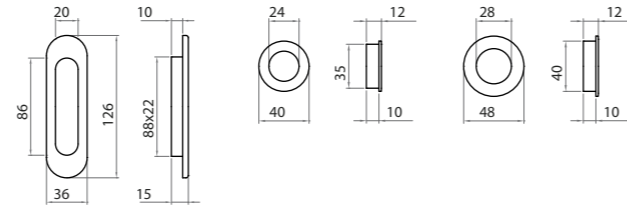

	NMA	NBI	NRO	Conf. Pz.
MINNY INCAS	88948700006	88948700007	88948700008	
Maniglia incasso ovale sliding door handle	1,93	1,93	1,93	24
MINNY INCAS MM 35	88948735006	88948735007	88948735008	
Maniglia incasso tonda mm 35 Round sliding door mm.35	1,93	1,93	1,93	50
MINNY INCAS MM 40	88948740006	88948740007	88948740008	
Maniglia incasso tonda mm 40 Round sliding door mm.40	1,93	1,93	1,93	50

	NGR	NAM	NVE	NNE	Conf. Pz.
MINNY INCAS	88948700002	88948700003	88948700004	88948700005	
Maniglia incasso ovale sliding door handle	1,93	1,93	1,93	1,93	24
MINNY INCAS MM 35	88948735002	88948735003	88948735004	88948735005	
Maniglia incasso tonda mm 35 Round sliding door mm.35	1,93	1,93	1,93	1,93	50
MINNY INCAS MM 40	88948740002	88948740003	88948740004	88948740005	
Maniglia incasso tonda mm 40 Round sliding door mm.40	1,93	1,93	1,93	1,93	50

## LIA

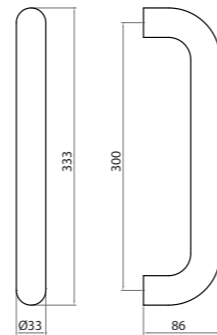

FISSAGGI NON INCLUSI  
FIXINGS NOT INCLUDED

	NGR	NNE	NMA	NBI	NRO	Conf. Pz.
MAN 300 DIR	88944602002	88944602005	88944602006	88944602007	88944602008	
Maniglione diritto mm 300 Straight pull handle	38,69	38,69	38,69	38,69	38,69	1



FISSAGGI NON INCLUSI  
FIXINGS NOT INCLUDED

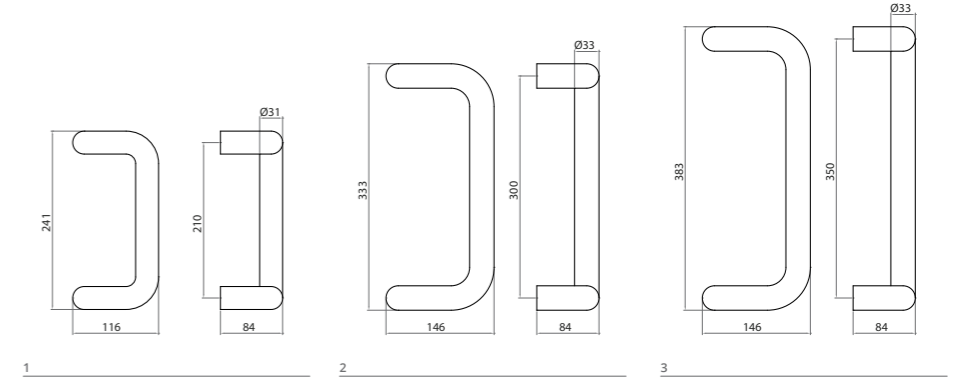

	NGR	NNE	NMA	NBI	NRO	Conf. Pz.
MAN 350 ZAN	88944613002	88944613005	88944613006	88944613007	88944613008	
Maniglione zancato mm 350 offset pull handle mm. 350	51,34	51,34	51,34	51,34	51,34	1
MAN 300 ZAN	88944612002	88944612005	88944612006	88944612007	88944612008	
Maniglione zancato mm 300 Offset pull handle mm.300	44,79	44,79	44,79	44,79	44,79	1

	NNE	NBI	Conf. Pz.
FISS SING VETRO MAN MM 300/350	88944687005	88944687007	
Fissaggio singolo per vetro man. mm 300/350 Accessories for single pull handle mm.300/350 glass door	8,34	8,34	1
FISS SING LEGNO-ALLUM MAN MM 300/350	88944687505	88944687507	
Fissaggio singolo per legno alluminio man. mm 300/350 Accessories for single pull handle mm.300/350 alu-wood door	9,61	9,61	1
FISS DOPP VETRO MAN MM 300/350	88944688005	88944688007	
Fissaggio doppio per vetro man. mm 300/350 Accessories for a pair of pull handle glass mm 300/350	18,66	18,66	1
FISS DOPP LEGNO-ALLUM MAN MM 300/350	88944688505	88944688507	
Fissaggio doppio per legno-alluminio man. mm 300/350 Accessories for a pair of pull handle mm.300/350 alu-wood door	30,55	30,55	1

UN FISSAGGIO SINGOLO PER OGNI MANIGLIONE

UN FISSAGGIO DOPPIO PER OGNI COPPIA DI MANIGLIONI

## PIPPO

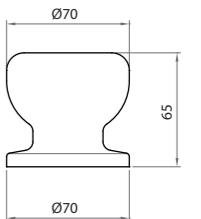

	NNE	NMA	NBI	NRO	Conf. Pz.
POM CP R70	88942770005	88942770006	88942770007	88942770008	
PIPPO POM70 CP knob mm 70	16,07	16,07	16,07	16,07	8

## MINNY

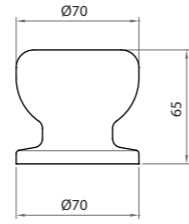

	NNE	NMA	NBI	NRO	Conf. Pz.
POM CP R70	88940770005	88940770006	88940770007	88940770008	8
MINNY POM70 CP knob mm 70	16,07	16,07	16,07	16,07	

## MINNY

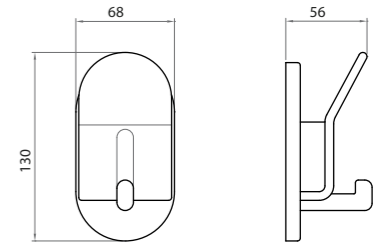

	NGI	NGR	NVE	NNE	NBI	NRO	Conf. Pz.
PORT	88940690001	88940690002	88940690004	88940690005	88940690007	88940690008	12
MINNY PORT hat & coat hook	10,12	10,12	10,12	10,12	10,12	10,12	

## DUMBO

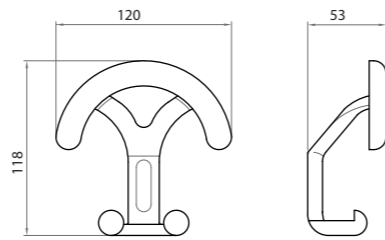

	NGI	NGR	NVE	NNE	NBI	NRO	Conf. Pz.
PORT	88946690001	88946690002	88946690004	88946690005	88946690007	88946690008	12
DUMBO PORT hat & coat hook	6,40	6,40	6,40	6,40	6,40	6,40	

## MINNY

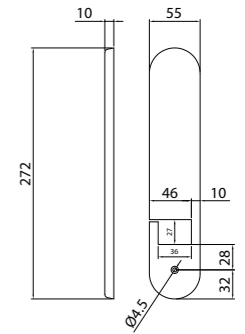

	NNE	NBI	Conf. Pz.
AVV	88948800005	88948800005	
Copriavvolgibile cover	2,35	2,35	

# 10

**Coordinati e  
complementi d'arredo**

**Accessories and  
furniture fittings  
and miscellaneous items**

470 Ganci rigidi / Door hooks  
470 Cricchetti / Ratchet windows  
471 Pinze fermaporte / Door stopper clamp  
471 Copri avvolgibili / Plates for roller shutter  
472 Fermaporte / Doorstop  
473 Supporti / Handrail supports  
474 Piedini / Brass adjusting screws  
475 Maniglie ponte / Bridge handles

# GANCI RIGIDI

OTTONE - ALLUMINIO



mm	A
mm 80	80
mm100	100
mm120	120
mm140	140

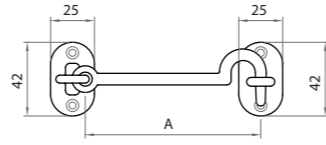

	OBR	OLV	OCL	Conf. Pz.
GANCIO MM80 RIG Gancio rigido mm 80 Hook mm 80	49208080000	49208080001	49208080003	24
GANCIO MM100 RIG Gancio rigido mm 100 Hook mm 100	49208100000	49208100001	49208100003	24
GANCIO MM120 RIG Gancio rigido mm 120 Hook mm 120	49208120000	49208120001	49208120003	24
GANCIO MM140 RIG Gancio rigido mm 140 Hook mm 140	49208140000	49208140001	49208140003	24

# PINZE FERMAPORTE

OTTONE - ALLUMINIO

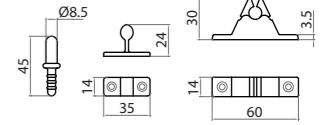
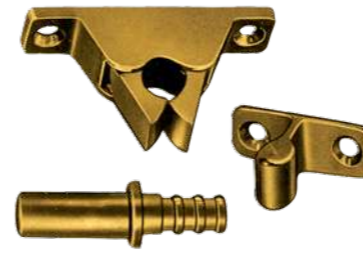

	OBR	OL	Conf. Pz.
PINZA F/PORT	49206000000	49206000001	50
door stop pliers	4,17	4,17	50
PRESA PINZA LEGNO	49206500000	49206500001	50
fitting for door stop plier	2,46	2,46	50
PRESA PINZA TERRA	49206520000	49206520001	50
fitting for door stop plier	1,93	1,93	50

# CRICCHETTI

OTTONE - ALLUMINIO

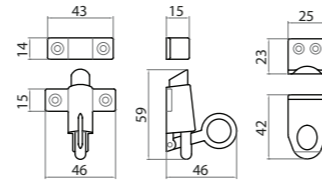

	OBR	OL	Conf. Pz.
CRICCHETT INC NORM Special window hook	49204100000	49204100001	25
CRICCHETT INC STAFFA Special window hook	49204200000	49204200001	25

# GIOIA

OTTONE

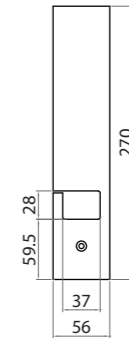

AL FINE DI EVITARE UN DETERIORAMENTO DELLA FINITURA SI CONSIGLIA DI RICAVARE IL SECONDO FORO VITE FORANDO DAL RETRO.

IN ORDER TO AVOID THE FINISHING'S DETERIORATION IT'S RECOMMENDED TO OBTAIN THE SECOND SCREW HOLE DRILLING FROM THE BACK.

	OLV	OCS	OGV	OCL	OS	Conf. Pz.
AVV AVVOLGIBILE RETTANGOLARE cover	44998800001	44998800003	44998800004	44998800007	44998800008	12
	26,19	32,59	26,19	32,59	26,19	12

## GIOIA

OTTONE

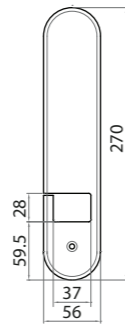

AL FINE DI EVITARE UN DETERIORAMENTO DELLA FINITURA SI CONSIGLIA DI RICAVARE IL SECONDO FORO VITE FORANDO DAL RETRO.

IN ORDER TO AVOID THE FINISHING'S DETERIORATION IT'S RECOMMENDED TO OBTAIN THE SECOND SCREW HOLE DRILLING FROM THE BACK.

	OLV	OLS	OCS	OGV	OCL	Conf. Pz.
AVV	55448800001	55448800002	55448800003	55448800004	55448800007	12
GIOIA AVV cover	26,19	26,19	32,59	26,19	32,59	

## POMELLI FERMAPORTE

ALLUMINIO



	F1	F4	GCTOL	GCTNS	Conf. Pz.
POM F/POR GOMMA	77225000001	77225000004	77225000012	77225000027	25
POM F/POR 28X40 ALL door stopper	5,65	5,65	6,84	6,84	

## POMELLI FERMAPORTE

OTTONE

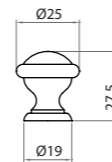

	OBR	OLV	OCL	Conf. Pz.
POM F/POR GOMMA	49225000000	49225000001	49225000007	25
POM.F/POR GOMMA door stopper	7,59	7,59	8,18	

## SUPPORTI PER CORRIMANO

OTTONE

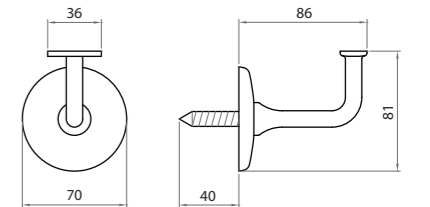
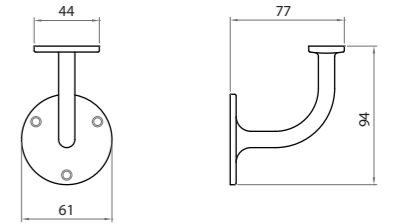
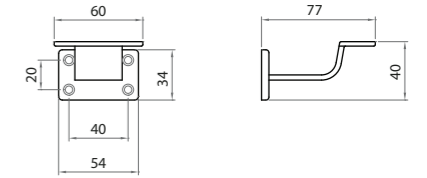
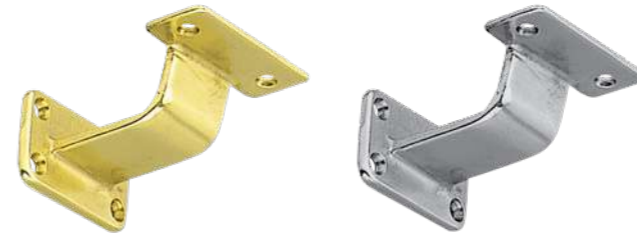

	OBR	OLV	OCS	Conf. Pz.
SUPPORTO QUADR CORR	49235101000	49235101001	49235101003	24
SUPPORTO MM70 CORR hand rail bracket	24,15	22,73	27,96	
SUPPORTO TONDO CORR	49235201000	49235201001		12
SUPPORTO TONDO CORR hand rail bracket	19,34	18,30		
SUPPORTO TONDO CORR C/V	49235251000	49235251001		12
SUPPORTO TONDO CORR C/V hand rail bracket	22,47	21,43		

# PIEDINI

OTTONE



	A	B	C	B
50 M12	50	60	M12	30
60 M12	60	60	M12	30

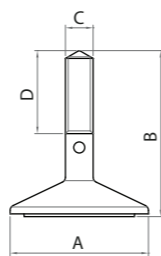

	Grezzo	Conf. Pz.
PIED.REG.MM50 M12 C/G	49219125001	60
PIED.REG. MM50 12MA C/G accessories for furniture 50mm	10,42	
PIED.REG.MM60 M12 C/G	49219126001	50
PIED.REG. MM60 12MA C/G accessories for furniture 60mm	12,35	

# PIEDINI

OTTONE



	A	B	C	B
50 M12	50	60	M12	30
60 M12	60	60	M12	30

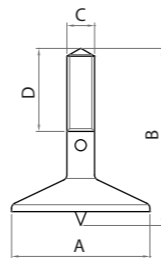

	Grezzo	Conf. Pz.
PIED.REG.MM50 M12 C/P	49217125001	60
PIED.REG. MM50 12MA C/P accessories for furniture 50mm	10,42	
PIED.REG.MM60 M12 C/P	49217126001	50
PIED.REG. MM60 12MA C/P accessories for furniture 60mm	12,35	

# PIEDINI

OTTONE



	A	B	C	B
30 M10	30	28	M10	15
35 M10	35	32	M10	18
40 M10	40	32	M10	17
50 M10	50	40	M10	22
60 M10	60	55	M10	30
50 M12	50	40	M10	22
60 M12	60	50	M10	26

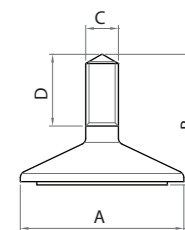

	Grezzo	Conf. Pz.
PIED.FIS.MM30 M10 C/G	49218103001	200
PIED.FIS. MM30 10MA C/G accessories for furniture 30mm	3,42	
PIED.FIS.MM35 M10 C/G	49218103501	200
PIED.FIS. MM35 10MA C/G accessories for furniture 35mm	4,02	
PIED.FIS.MM40 M10 C/G	49218104001	100
PIED.FIS. MM40 10MA C/G accessories for furniture 40mm	4,76	
PIED.FIS.MM50 M10 C/G	49218105001	100
PIED.FIS. MM50 10MA C/G accessories for furniture 50mm	5,95	
PIED.FIS.MM60 M10 C/G	49218106001	100
PIED.FIS. MM60 10MA C/G accessories for furniture 60mm	8,63	
PIED.FIS.MM50 M12 C/G	49218125001	100
PIED.FIS. MM50 12MA C/G accessories for furniture 50mm	7,14	
PIED.FIS.MM60 M12 C/G	49218126001	50
PIED.FIS. MM60 12MA C/G accessories for furniture 60mm	9,82	

# MANIGLIETTA PONTE

OTTONE

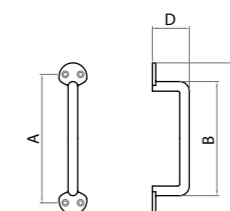

INTER-ASSE	A	B	C	C
100	84	123	35	
mm100	120	104	143	35
mm120	134	119	158	35
mm140	160	140	188	40
mm160				

FINITURA FINISHING  
OLV-M1

	OLV	OGV	Conf. Pz.
MAN PONTE MM 100	49236100001	49236100004	24
Maniglietta a ponte mm 100 Carrying handle	11,76	11,76	
MAN PONTE MM 120	49236120001	49236120004	24
Maniglietta a ponte mm 120 Carrying handle 120	12,80	12,80	
MAN PONTE MM 140	49236140001	49236140004	24
Maniglietta a ponte mm 140 Carrying handle 140	13,69	13,69	
MAN PONTE MM 160	49236160001	49236160004	24
Maniglietta a ponte mm 160 Carrying handle 160	14,73	14,73	

# 11

478 Arsenio  
479 Ometti

**Accessori per infissi esterni**

**Windows accessories  
equipment**

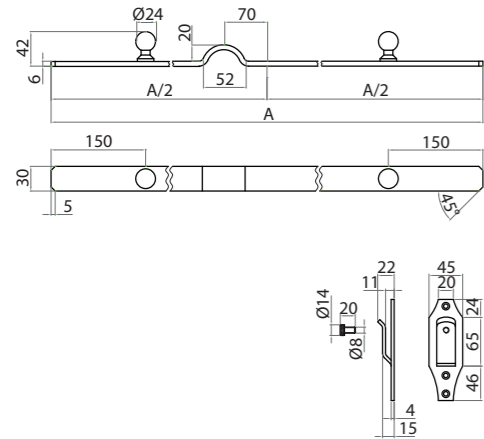

	FZTN	Conf. Pz.
ASTA DI SICUREZZA CM. 60	33182060007	
Asta di sicurezza cm.60	31,99	10
Safety bar cm.60		
ASTA DI SICUREZZA CM. 70	33182070007	
Asta di sicurezza cm.70	31,99	10
Safety bar cm.70		
ASTA DI SICUREZZA CM. 80	33182080007	
Asta di sicurezza cm.80	31,99	10
Safety bar cm.80		
ASTA DI SICUREZZA CM. 90	33182090007	
Asta di sicurezza cm.90	31,99	10
Safety bar cm.90		
ASTA DI SICUREZZA CM. 100	33182100007	
Asta di sicurezza cm.100	34,08	10
Safety bar cm.100		
ASTA DI SICUREZZA CM. 110	33182110007	
Asta di sicurezza cm.110	34,08	10
Safety bar cm.110		
ASTA DI SICUREZZA CM. 120	33182120007	
Asta di sicurezza cm.120	34,08	10
Safety bar cm.120		
ASTA DI SICUREZZA CM. 140	33182140007	
Asta di sicurezza cm.140	35,56	10
Safety bar cm.140		
INCONTRO CON CHIUSURA	33184500007	
Incontro con chiusura	8,48	10
Hook		

## OMETTI SENZA VITE / SHUTTER STOP WITHOUT SCREW

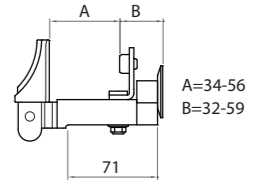

	FZTN	Conf. Pz.
ASTA DI SICUREZZA CM. 60	33182060007	
Asta di sicurezza cm.60	31,99	10
Safety bar cm.60		
ASTA DI SICUREZZA CM. 70	33182070007	
Asta di sicurezza cm.70	31,99	10
Safety bar cm.70		
ASTA DI SICUREZZA CM. 80	33182080007	
Asta di sicurezza cm.80	31,99	10
Safety bar cm.80		
ASTA DI SICUREZZA CM. 90	33182090007	
Asta di sicurezza cm.90	31,99	10
Safety bar cm.90		
ASTA DI SICUREZZA CM. 100	33182100007	
Asta di sicurezza cm.100	34,08	10
Safety bar cm.100		
ASTA DI SICUREZZA CM. 110	33182110007	
Asta di sicurezza cm.110	34,08	10
Safety bar cm.110		
ASTA DI SICUREZZA CM. 120	33182120007	
Asta di sicurezza cm.120	34,08	10
Safety bar cm.120		
ASTA DI SICUREZZA CM. 140	33182140007	
Asta di sicurezza cm.140	35,56	10
Safety bar cm.140		
INCONTRO CON CHIUSURA	33184500007	
Incontro con chiusura	8,48	10
Hook		

## PROTEZIONE IN PVC / PVC PROTECTION



	PVC	Conf. Pz.
PROTEZIONE PER TESTA ALTA	18409110005	
Protezione per testa alta	0,60	10
Rubber protection		



## OMETTI / SHUTTER STOP

FERRO

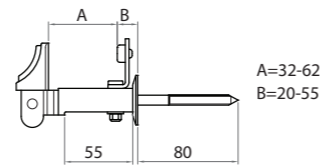

1

A=32-62  
B=20-55

2

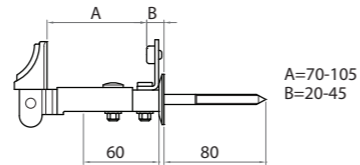
A=70-105  
B=20-45

3

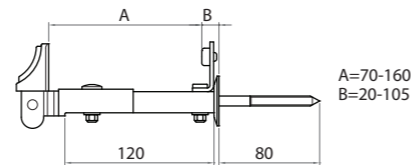
A=70-160  
B=20-105

## OMETTI / SHUTTER STOP

FERRO

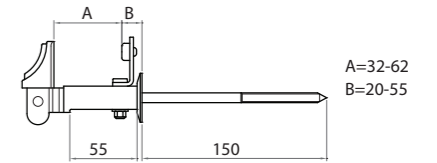

4

A=32-62  
B=20-55

5

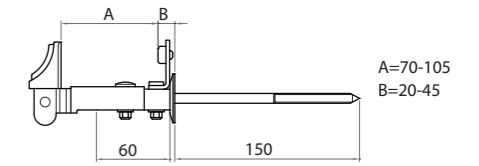
A=70-105  
B=20-45

6

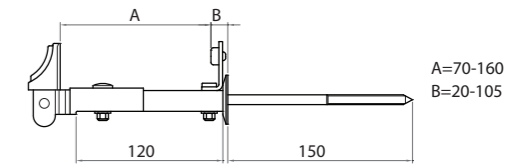
A=70-160  
B=20-105

	FZT	FZTN	Conf. Pz.
OMETTO BIG VITE 2RG Ometto BIG con vite 2 regolazioni Shutter stop	33030290006 8,78	33032290007 7,14	20
OMETTO BIG VITE 2RG TESTA ALTA Ometto BIG con vite 2 regolazioni testa alta Shutter stop	33030290106 9,37	33032290107 8,05	20
OMETTO BIG VITE 2RG SP. ANTA 70 Ometto BIG con vite 2 regolazioni spessore anta mm 70 Shutter stop	33030291006 8,78	33032291007 7,14	20
OMETTO BIG VITE 2RG SP. ANTA 70 TESTA ALTA Ometto BIG con vite 2 regolazioni spessore anta mm 70 testa al Shutter stop	33030291106 9,37	33032291107 7,29	20
OMETTO BIG VITE 2RG DOPPIO Ometto BIG con vite 2 regolazioni doppio Shutter stop	33030295006 9,67	33032295007 9,07	15
OMETTO BIG VITE 2RG DOPPIO TESTA ALTA Ometto BIG con vite 2 regolazioni doppio testa alta Shutter stop	33030295106 10,27	33032295107 8,33	15

	FZT	FZTN	Conf. Pz.
OMETTO BIG VITE 150 2RG Ometto BIG con vite mm 150 2 regolazioni Shutter stop	33030300006 11,90	33032300007 10,71	15
OMETTO BIG VITE 150 2RG TESTA ALTA Ometto BIG con vite mm 150 2 regolazioni testa alta Shutter stop	33030300106 12,65	33032300107 10,86	15
OMETTO BIG VITE 150 2RG SP. ANTA 70 Ometto BIG con vite mm 150 2 regolazioni spessore anta mm 70 Shutter stop	33030301006 13,24	33032301007 11,90	15
OMETTO BIG VITE 150 2RG SP. ANTA 70 TESTA ALTA Ometto BIG con vite mm 150 2 regolazioni spessore anta mm 70 Shutter stop	33030301106 13,69	33032301107 12,05	15
OMETTO BIG VITE 150 2RG DOPPIO Ometto BIG con vite mm 150 2 regolazioni doppio Shutter stop	33030305006 13,24	33032305007 11,90	10
OMETTO BIG VITE 150 2RG DOPPIO TESTA ALTA Ometto BIG con vite mm 150 2 regolazioni doppio testa alta Shutter stop	33030305106 13,69	33032305107 12,05	10

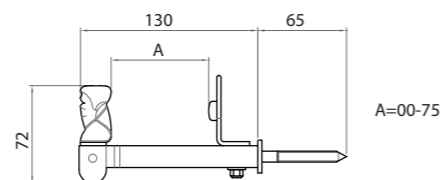
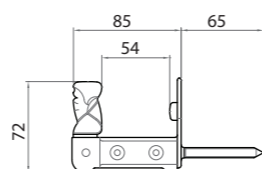
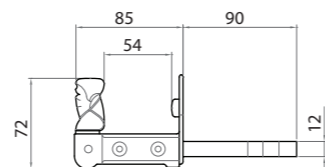
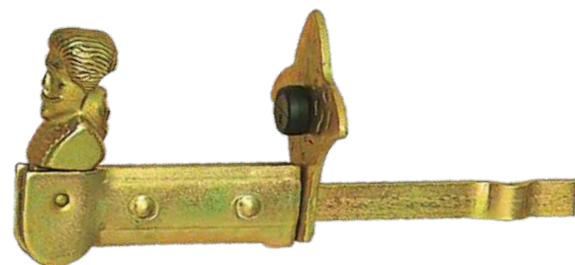

	FN	FZT	FZTN	Conf. Pz.
OMETTO FERMO ZANCA Ometto con fermo e zanca Shutter stop	33030100005	33030100006	33030100007	20
OMETTO FOGLIA REGIS ZANCA Ometto con foglia registrabile e zanca Shutter stop	33030120005	33030120006	33030120007	20
OMETTO FERMO VITE TAS Ometto con fermo vite e tassello Shutter stop	33030150005	33030150006	33030150007	20
OMETTO FOGL REGIS VITE Ometto con foglia registrabile e vite Shutter stop	33030170005	33030170006	33030170007	20

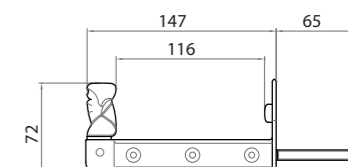
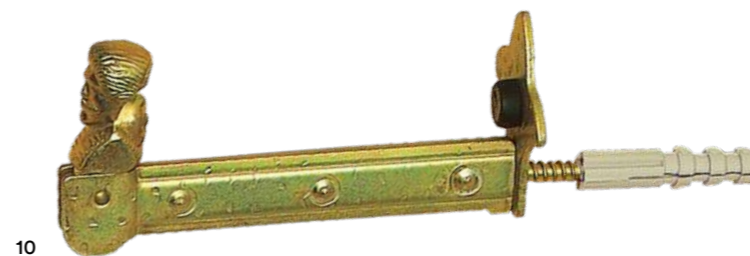

10

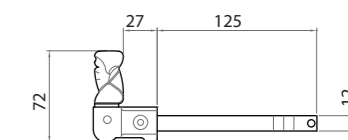
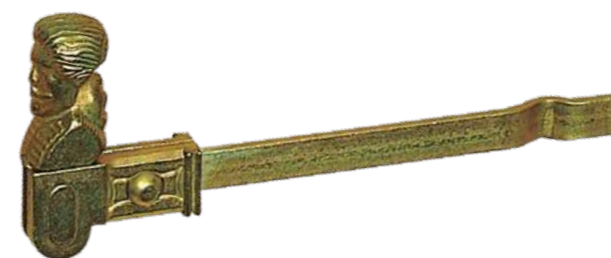

11

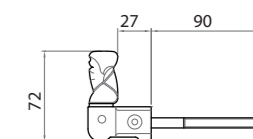
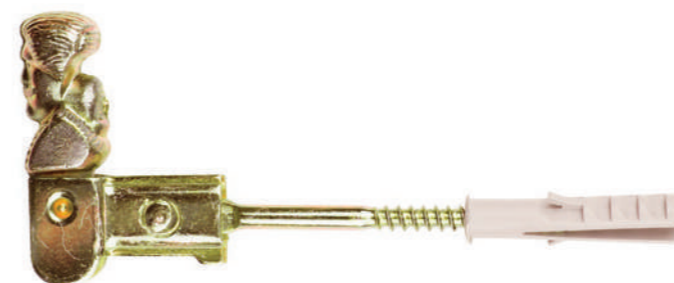

12

	FN	FZT	FZTN	Conf. Pz.
OMETTO FERMO VITE TAS DOP Ometto con fermo vite e tassello doppio Shutter stop	33030155005	33030155006	33030155007	15
OMETTO ZANCA Ometto con zanca Shutter stop	33030000005	33030000006		30
OMETTO VITE TAS Ometto con vite e tassello Shutter stop	33030050005	33030050006		30

13

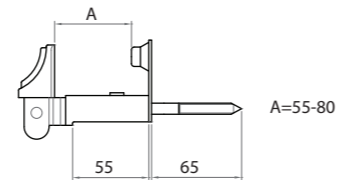

14

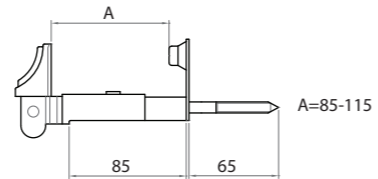

15

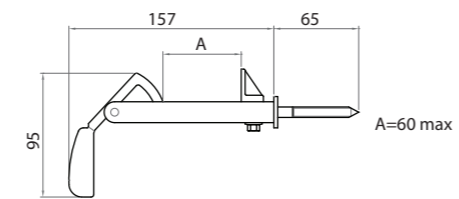

16

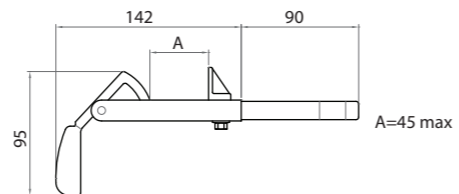

	FN	FZT	FZTN	Conf. Pz.
OMETTO MODER VITE TAS Ometto moderno con vite e tassello Shutter stop		33030250006 8,63	33032250007 6,55	20
OMETTO MODER VITE TAS DOP Ometto moderno con vite e tassello doppio Shutter stop		33030255006 8,63	33032255007 6,55	20
FERMAIMP VITE REG Fermaimposte con vite regolabile shutter stop	33031055005 9,23	33031055006 9,23		15
FERMAIMP ZANCA REG Fermaimposte con zanca regolabile shutter stop	33031005005 9,23	33031005006 9,23		15
FERMAIMP REG MM.105 VITE C/MOLLA Fermaimposte corto con vite regolabile con molla shutter stop		33031052006 10,12	33031052007 10,42	20
FERMAIMP REG. MM.125 VITE C/MOLLA Fermaimposte corto con zanca regolabile con molla shutter stop		33031051006 10,12	33031051007 10,42	15

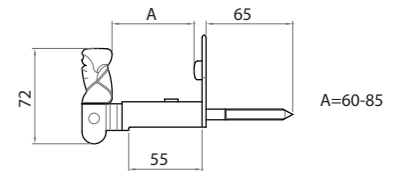
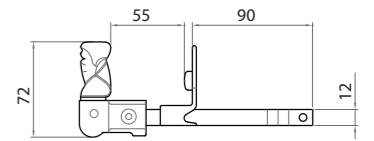

	FN	FZT	FZTN	Conf. Pz.
OMETTO FERMO ZANCA EC Ometto con fermo e zanca economico Shutter stop	33030140005 5,95			20
OMETTO FERMO VITE EC Ometto con fermo e vite economico Shutter stop	33030190005 6,10			20
OMETTO BIG FOGL REG VITE TAS Ometto BIG regolabile con foglia vite tasello Shutter stop		33030270006 8,33	33030270007 8,93	20
OMETTO BIG FOGL REG VITE TAS DOP Ometto BIG regolabile con foglia vite tasello doppio Shutter stop		33030275006 8,48	33030275007 9,08	20

**12**

**Metalmecc**



FERRO

	ZMN	Conf. Pz.
Q8 MM25 C/V Guarnitura Q8x25 con vite in testa Lever handle 8x25mm with screw	66970000016 10,71	10
Q8 MM35 C/V Guarnitura Q8x35 con vite in testa Lever handle 8x35mm with screw	66970035016 6,40	10
Q8 MM40 C/V Guarnitura Q8x40 con vite in testa Lever handle 8x40mm with screw	66970040016 6,40	10
Q8 MM45 C/V Guarnitura Q8x45 con vite in testa Lever handle 8x45mm with screw	66970045016 11,01	10
Q8 MM50 C/V Guarnitura Q8x50 con vite in testa Lever handle 8x50mm with screw	66970050016 11,01	10
Q8 MM60 C/V Guarnitura Q8x60 con vite in testa Lever handle 8x60mm with screw	66970060016 11,16	10
Q8 MM70 C/V Guarnitura Q8x70 con vite in testa Lever handle 8x70mm with screw	66970070016 11,16	10
Q8 MM80 C/V Guarnitura Q8x80 con vite in testa Lever handle 8x80mm with screw	66970080016 11,16	10

FERRO



	ZMN	Conf. Pz.
Q8 C/V TORCIGLIO.Q8 C/V Pair of lever handle with 1 screw visible	66974000016 16,96	10

FERRO



	ZMN	Conf. Pz.
Q8 RP SPINATA ZAMPA Q8 SP40 R Lever handle 8mm on small rose fixed	66982000016 11,90	10

# MANIGLIETTE FISSE

FERRO



	ZMN	Conf. Pz.
MAN FISSA SAG MM150	66912150016	
MANIGL. FISSA SAG 150 Fixed handle mm.150	3,57	10

# SAP

FERRO



	ZTR	MEC	Conf. Pz.
MAN BLOCCO	66900000006	66900000016	
SAP MAN BLOCCO Handle	16,07	16,07	10

# MANIGLIETTE FISSE

FERRO



	ZMC	Conf. Pz.
MAN FISSA SCANN MM100	66912010003	
MAN.FISSA SCANN.MM100 Fixed handle mm.100	3,57	10
MAN FISSA SCANN MM120	66912012003	
MAN.FISSA SCANN.MM120 Fixed handle mm.120	4,54	10
MAN FISSA SCANN MM140	66912014003	
MAN.FISSA SCANN.MM140 Fixed handle mm.140	4,91	10
MAN FISSA SCANN MM160	66912016003	
MAN.FISSA SCANN.MM160 Fixed handle mm.160	6,10	10

# 13

**Espositori**

**Display units**

# ESPOSITORE FREESTANDING

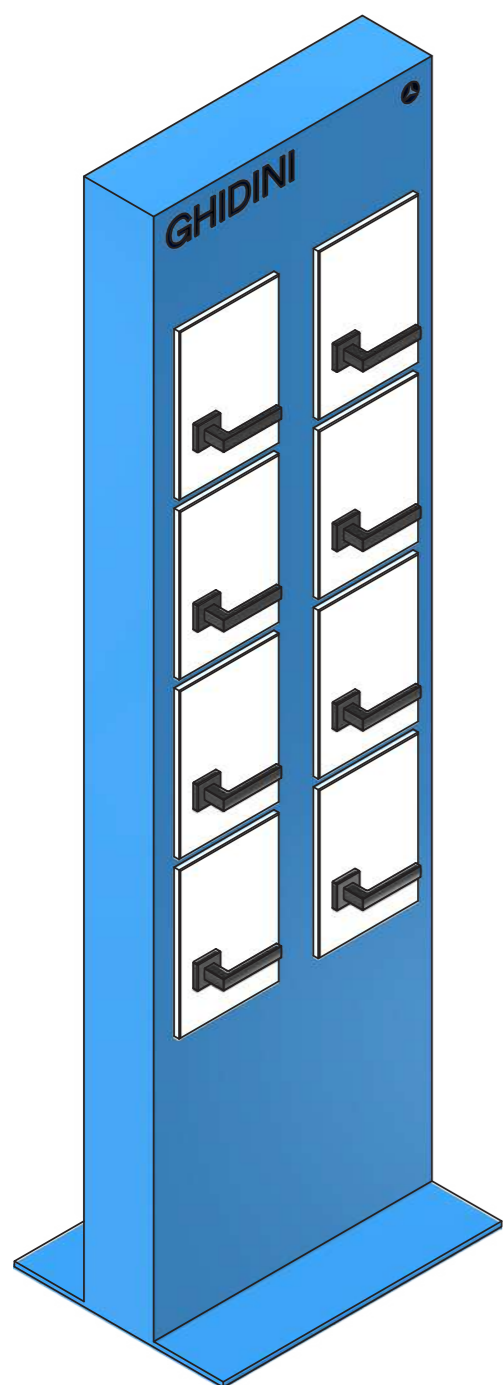

	nero	Conf. Pz.
ESPOSIT. TOTEM DOPPIA COLONNA	19005526000	
16 pannelli H.210 -L.60	1000,73	

# ESPOSITORE A PARETE - MODULO 2



	nero	Conf. Pz.
ESPOSIT. PARETE	19005301100	
8 pannelli H.210 - L.60	324,56	
INSERTO PER PANNELLI LED	19005700700	
	649,13	



# ESPOSITORE A PARETE - MODULO 3

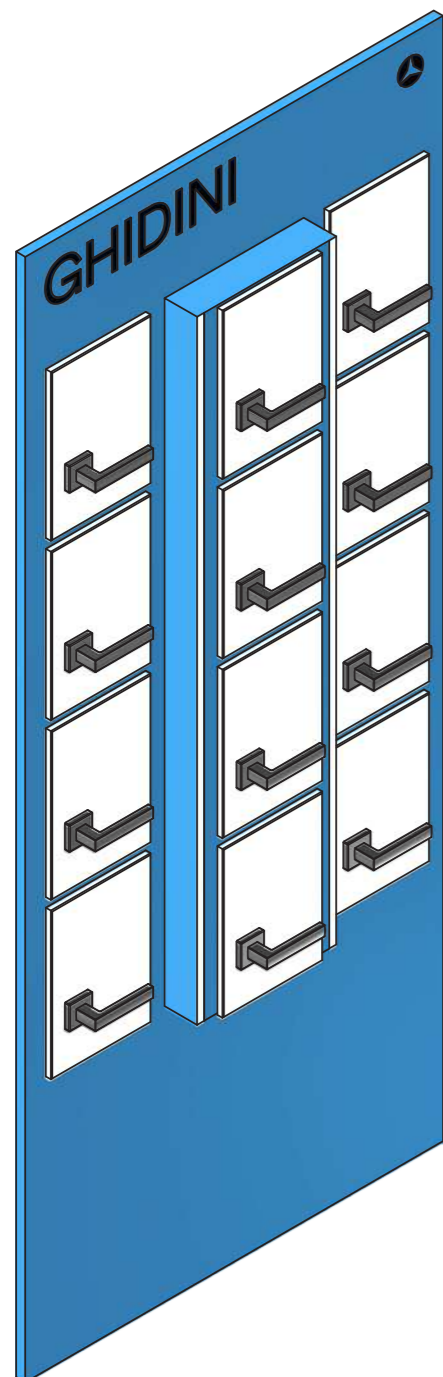

ESPOSIT. PARETE  
12 pannelli H.210 - L.90

INSERTO PER PANNELLI LED

nero	Conf. Pz.
19005301000	398,95
19005700700	649,13

# ESPOSITORE DA BANCO

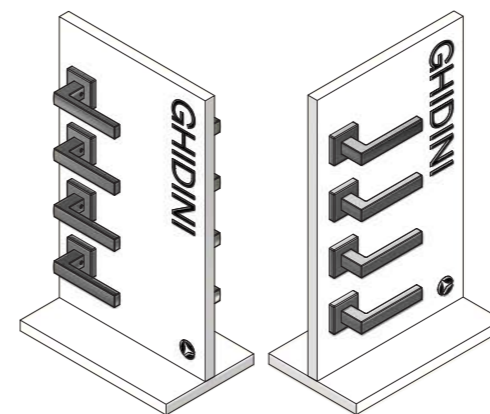

ESPOSITORE DA BANCO BASE RETT  
PANNELLO 315X215 BASE 215X110

bianco	Conf. Pz.
19005701000	50,72

# PANNELLO SINGOLO

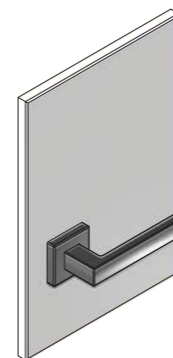

PANNELLO CON FRESATE POSTERIORI  
mm 215x315x14 BIANCO

bianco	Conf. Pz.
19005401500	35,16

# BAULETTO FINITURE GALATTICHE



ESPOSITORE A BAULETTO  
7900 "FINITURE GALATTICHE"

ESPOSITORE A BAULETTO  
141 "FINITURE GALATTICHE"

avana	Conf. Pz.
19005600300	125,00
19005600400	125,00

# 14

## Approfondimenti

### In-depth study

500	Riepilogo finiture / Finishing summary
501	Resistenza alla corrosione / Corrosion resistance
502	Ghi.co.tec
504	G-Plus
506	Avvertenze / Warnings
508	Condizioni Generali di Vendita / General Terms and Conditions of Sales
514	Contatti

# Riepilogo Finiture Finishing summary

MATERIALE MATERIAL	SIGLIA ACRONYM	DESCRIZIONE FINITURA FINISH DESCRIPTION
ottone brass	OANT	ottone brunito anticato <i>antiqued bronzed brass</i>
ottone brass	OLD	ottone anticato naturale <i>antiqued natural brass</i>
ottone brass	ONL	ottone nichel lucido <i>polished nickel brass</i>
ottone brass	OL	ottone lucido <i>polished brass</i>
ottone brass	OLV	ottone lucido verniciato <i>polished painted brass</i>
ottone brass	OCS	ottone satinato <i>chromed satin brass</i>
ottone brass	OCL	ottone lucido <i>polished chrome</i>
ottone brass	ONS	nichel satinato <i>satin nickel</i>
ottone brass	OGV	ottone graffiato verniciato <i>scratched paintedbrass</i>
ottone brass	OS	ottone satinato verniciato <i>brushed brass</i>
ottone brass	OLS	ottone lucido e satinato <i>brushed polished brass</i>
ottone brass	OTTONE RAL	ral verniciati <i>painted ral</i>
ottone brass	OBR	ottone brunito <i>bronzed brass</i>
ottone brass	OFA	ottone nichelato brunito vibrato verniciato <i>old iron brass</i>
ottone brass	OF	ottone brunito lucidato verniciato <i>brass fumè</i>
ottone brass	GPLUS	ottone lucido pvd <i>polished brass with physical vapour deposition treatment</i>
zama zamak	ZCL	ottone lucido <i>polished chrome</i>
zama zamak	ZCS	ottone satinato <i>satin chrome</i>
zama zamak	ZGV	graffiato brunito verniciato lucido <i>scratched bronzed polished painted</i>
zama zamak	ZNS	nichel satinato <i>satin nickel</i>
zama zamak	ZAMA RAL	ral verniciati <i>painted ral</i>
zama zamak	ZNO	nero verniciato <i>black painted</i>
zama zamak	GCTOL	ottone lucido GHICOTEC <i>polished brass GHICOTEC</i>
zama zamak	TITANIUM	titanio <i>titanium</i>
zama zamak	Z-BGO	brunito graffiato opaco <i>burnished scratched matte</i>
zama zamak	Z-OSO	ottone satinato opaco <i>matte satin brass</i>
zama zamak	ZBR	brunito verniciato opaco <i>burnished matte painted</i>
zama zamak	BORGOGNA	brunito graffiato verniciato opaco <i>burnished scratched matte painted</i>
zama zamak	CHAMPAGNE	brunito sfumato verniciato opaco su base oro <i>burnished shaded matte painted on gold base</i>
zama zamak	LORENA	brunito verniciato opaco <i>burnished matte painted</i>
zama zamak	NORMANDIA	brunito sfumato verniciato opaco su base argento <i>burnished shaded matte painted on silver base</i>

alluminio aluminium	F1	argento <i>silver</i>
alluminio aluminium	F3	oro <i>gold</i>
alluminio aluminium	F4	bronzo <i>bronze</i>
alluminio aluminium	F9	inox <i>inox</i>
alluminio aluminium	F1-SAT	argento satinato <i>satin silver</i>
alluminio aluminium	JUPITER	bronzo satinato <i>satin bronze</i>
alluminio aluminium	MERCURY	argento satinato <i>satin silver</i>
alluminio aluminium	SPACE	nero satinato <i>satin black</i>
alluminio aluminium	URANUS	inox satinato <i>satin inox</i>
alluminio aluminium	ACL	ottone lucido <i>polished chrome</i>
alluminio aluminium	ACS	ottone satinato <i>satin chrome</i>
alluminio aluminium	ALLUMINIO RAL	ral verniciati <i>painted ral</i>
alluminio aluminium	ANO	nero verniciato <i>black painted</i>
alluminio aluminium	ACP	ottone perla <i>pearl chrome</i>
alluminio aluminium	GCTOL	oro lucido GHICOTEC <i>polished gold GHICOTEC</i>
alluminio aluminium	GCTCL	ottone lucido GHICOTEC <i>polished chrome GHICOTEC</i>
alluminio aluminium	GCTOS	oro satinato GHICOTEC <i>satin gold GHICOTEC</i>
alluminio aluminium	GCTCS	ottone satinato GHICOTEC <i>satin chrome GHICOTEC</i>
alluminio aluminium	GCTNS	nichel satinato GHICOTECH <i>satin nickel GHICOTECH</i>
alluminio aluminium	ACH	argento verniciato <i>silver painted</i>
nylon nylon	NAM	amaranto <i>amaranth</i>
nylon nylon	NBI	bianco <i>white</i>
nylon nylon	NGI	giallo <i>yellow</i>
nylon nylon	NGR	grigio <i>grey</i>
nylon nylon	NMA	marrone <i>brown</i>
nylon nylon	NNE	nero <i>black</i>
nylon nylon	NRO	rosso <i>red</i>
nylon nylon	NVE	verde <i>green</i>

# Resistenza alla corrosione Corrosion resistance

## Resistenza alla corrosione in riferimento alle norme UNI EN ISO 9227 EN 1670:2007

La norma specifica i requisiti di resistenza alla corrosione degli accessori per porte, finestre, chiusure oscuranti e facciate continue. Si applica anche agli elementi di collegamento metallico richiesti per il fissaggio degli accessori per serramenti.

## Corrosion resistance according to UNI EN ISO 9227 EN 1670:2007

The standard specifies the corrosion resistance requirements for accessories for doors, windows, shutters, and curtain walls. It also applies to the metal connecting elements required for securing the window fittings.

MATERIALE MATERIAL	SIGLIA ACRONYM	DESCRIZIONE FINITURA FINISH DESCRIPTION	24+1 ore in nebbia salina	48+1 ore in nebbia salina	96+1 ore in nebbia salina	240+1 ore in nebbia salina	480+1 ore in nebbia salina
			low corrosion resistance	moderate corrosion resistance	high corrosion resistance	very high corrosion resistance	exceptionally corrosion resistance
			GRADO CLASSE 1	GRADO CLASSE 2	GRADO CLASSE 3	GRADO CLASSE 4	GRADO CLASSE 5
			GRADE CLASS 1	GRADE CLASS 2	GRADE CLASS 3	GRADE CLASS 4	GRADE CLASS 5
ottone brass	OLV	ottone lucido verniciato <i>polished painted brass</i>	x				
ottone brass	OCS	ottone satinato <i>satin chrome</i>				x	
ottone brass	OCL	ottone lucido <i>polished chrome</i>					x
ottone brass	ONS	nichel satinato <i>satin nickel</i>			x		
ottone brass	OGV	ottone graffiato verniciato <i>scratched paintedbrass</i>	x				
ottone brass	OS	ottone satinato verniciato <i>brushed brass</i>	x				
ottone brass	OLS	ottone lucido e satinato <i>brushed polished brass</i>	x				
ottone brass	OTTONE RAL	ral verniciati <i>painted ral</i>					x
ottone brass	OBR	ottone brunito <i>bronzed brass</i>				x	
ottone brass	OFA	ottone nichelato brunito vibrato verniciato <i>old iron brass</i>					x
ottone brass	OF	ottone brunito lucidato verniciato <i>brass fumè</i>		x			
ottone brass	GPLUS	ottone lucido pvd <i>polished brass with physical vapour deposition treatment</i>					x
zama zamak	ZCL	ottone lucido <i>polished chrome</i>					x
zama zamak	ZCS	ottone satinato <i>satin chrome</i>			x		
zama zamak	ZNS	nichel satinato <i>satin nickel</i>			x		
zama zamak	ZAMA RAL	ral verniciati <i>painted ral</i>				x	
zama zamak	ZNO	nero verniciato <i>black painted</i>				x	
zama zamak	GCTOL	ottone lucido GHICOTEC <i>polished brass GHICOTEC</i>					x
alluminio aluminium	F1	argento <i>silver</i>					x
alluminio aluminium	F3	oro <i>gold</i>					x
alluminio aluminium	F4	bronzo <i>bronze</i>					x
alluminio aluminium	F9	inox <i>inox</i>					x
alluminio aluminium	F1-SAT	argento satinato <i>satin silver</i>					x
alluminio aluminium	JUPITER	bronzo satinato <i>satin bronze</i>					x
alluminio aluminium	MERCURY	argento satinato <i>satin silver</i>					x
alluminio aluminium	SPACE	nero satinato <i>satin black</i>					x
alluminio aluminium	URANUS	inox satinato <i>satin inox</i>					x
alluminio aluminium	ACL	ottone lucido <i>polished chrome</i>					x
alluminio aluminium	ACS	ottone satinato <i>satin chrome</i>					x
alluminio aluminium	ALLUMINIO RAL	ral verniciati <i>painted ral</i>					x
alluminio aluminium	ANO	nero verniciato <i>black painted</i>					x
alluminio aluminium	ACP	ottone perla <i>pearl chrome</i>					x
alluminio aluminium	GCTOL	oro lucido GHICOTEC <i>polished gold GHICOTEC</i>					x
alluminio aluminium	GCTCL	ottone lucido GHICOTEC <i>polished chrome GHICOTEC</i>					x
alluminio aluminium	GCTOS	oro satinato GHICOTEC <i>satin gold GHICOTEC</i>					x
alluminio aluminium	GCTCS	ottone satinato GHICOTEC <i>satin chrome GHICOTEC</i>					x
alluminio aluminium	GCTNS	nichel satinato GHICOTECH <i>satin nickel GHICOTECH</i>					x
alluminio aluminium	ACH	argento verniciato <i>silver painted</i>					x
alluminio aluminium	ACS	ottone satinato <i>satin chrome</i>			x		
alluminio aluminium	ALLUMINIO RAL	ral verniciati <i>painted ral</i>					x
alluminio aluminium	ANO	nero verniciato <i>black painted</i>					x
alluminio aluminium	ACP	ottone perla <i>pearl chrome</i>			x		
alluminio aluminium	GCTOL	oro lucido GHICOTEC <i>polished gold GHICOTEC</i>					x
alluminio aluminium	GCTCL	ottone lucido GHICOTEC <i>polished chrome GHICOTEC</i>					x
alluminio aluminium	GCTOS	oro satinato GHICOTEC <i>satin gold GHICOTEC</i>			x		
alluminio aluminium	GCTCS	ottone satinato GHICOTEC <i>satin chrome GHICOTEC</i>			x		
alluminio aluminium	GCTNS	nichel satinato GHICOTECH <i>satin nickel GHICOTECH</i>			x		

Nel 1995 entra in funzione il nuovo impianto per il trattamento denominato GHI.CO.TEC., Ghidini Coating Tecnology, un nuovo modo di concepire protezione e colorazione di maniglie e coordinati in ottone, Zama, alluminio.

Mediante un processo di cataforesi GHI.CO.TEC. deposita sul metallo resine che aderiscono ad esso per azione di un campo elettrico che si genera nelle vasche in cui i pezzi vengono immersi; con un successivo passaggio a forno la resina si indurisce ed il pezzo assume l'aspetto definitivo. La resina di base è trasparente ed incolore, ma con l'aggiunta di pigmenti potrebbe assumere qualsiasi colorazione. nel nostro caso utilizziamo la protezione incolore su ottone lucidato e quella "gialla" su zama ed alluminio.

Per l'ottone, GHI.CO.TEC., è dunque un'alternativa alla tradizionale verniciatura trasparente. Mentre per zama ed alluminio in un unico passaggio, il pezzo si colora, assumendo il tono dell'ottone, e si protegge dall'ossidazione e dall'usura con un deposito diretto sul metallo di base. Il rivestimento ha uno spessore assolutamente uniforme e garantisce caratteristiche di resistenza ad usura e ossidazione superiori a quanto ottenibile con i trattamenti tradizionali.

Da non trascurare l'aspetto ecologico del processo che lavora completamente a ciclo chiuso, quindi senza scarichi nell'ambiente e senza sviluppo di fumi o sostanze nocive per gli operatori.

In 1995 the new plant for the GHI.CO.TEC., Ghidini Coating Technology, started working.

This new plant is a new way to conceive protection and colouring of brass, zamak or aluminium handles and co-ordinates.

By means of a cataphoresis process, GHI.CO.TEC. deposits resins on metal and they adhere to it through an electric field which is generated in the bath tank where the pieces are dipped; with a further kiln step, the resin hardens and the piece takes the definite look.

The basic resin is transparent and colourless, but adding pigments, it can acquire any sort of colour. In our case we use a colourless protection on polished brass and a "yellow" protection on zamak or aluminium.

As far as brass is concerned, GHI.CO.TEC. is therefore a great change to the traditional transparent coating. Instead of treating zamak and aluminium with the usual brass coating galvanized system, with a single GHI.CO.TEC. operation, it is possible to colour the article and at the same time give it the right protection from oxidation.

The coating is absolutely uniform as far as the thickness is concerned and guarantees those characteristics of hardness, adhesion, resistance to solvents and to corrosion in saline fog, with better results compared to those which could be reached by means of traditional treatments.

The ecological aspect has to be taken into account as well, being the process a closed cycle, therefore no emissions in the environment, no fumes or dangerous substances for the operators are developed.

# G-plus

## G-PLUS

Ghidini group, proseguendo la propria ricerca che tende ad offrire i migliori caratteri tecnici e formali, presenta G-PLUS: il più aggiornato sviluppo della tecnologia PVD (Physical Vapour Deposition) applicata alle maniglie ed ai coordinati. Superficie dura e compatta, grande resistenza alle abrasioni ed alle aggressioni atmosferiche ed un piacevolissimo colore vivo dell'ottone sono i caratteri che distinguono G-PLUS.

G-PLUS realizza rivestimenti ad elevate caratteristiche mediante condensazione sotto vuoto sulla base da rivestire di vapori ottenuti con fattori fisici.

G-PLUS prevede una reazione fisica tra ioni di zirconio che si depositano sulla base in ottone precedentemente nichelata e cromata.

La generazione dei vapori avviene per effetto di una scarica ad arco sotto vuoto tra un catodo, ovvero la sorgente dei vapori stessi e la camera in cui avviene l'intero processo.

Le maniglie ed i coordinati trattati con G-PLUS godono di caratteristiche ampiamente superiori rispetto a quanto possibile con tutti i trattamenti tradizionali. Prendendo come termine di confronto la cromatura galvanica otteniamo:

G-PLUS ha superato severi test di laboratorio che ci consentono di certificare:

- Aderenza 100% secondo la normativa UNI-ISO 4524/5
- Nessuna alterazione dopo 1000 ore di prova accelerata di resistenza alla luce secondo la normativa UNI 9397
- Nessun intacco da parte di acido cloridrico, solforico, nitrico, ossalico, acetico e citrico, soda e potassa caustica, cianuri e sgrassature alcaline a caldo.

I risultati di protezione del trattamento G-PLUS permettono, anche ai clienti più esigenti, di ottenere maniglie e coordinati con una superficie di durezza paragonabile all'acciaio, resistenza agli agenti atmosferici che ne permette l'uso anche in esposizioni esterne in ambienti aggressivi, brillantezza del colore dell'ottone grazie alla protezione inalterabile nel tempo, garanzia illimitata perchè la protezione offerta supera anche i limiti di garanzia previsti per legge.

# G-plus

## G-PLUS

Carrying on their research in order to offer the best technical and formal features, GHIDINI group are presenting G-PLUS: the most up to date technological development: PVD (Physical Vapour Deposition) applied to handles and co-ordinates. Hard and compact surface, great abrasion proof, atmospheric aggression resistant and a very pleasant vivid brass colour are the features which distinguish G-PLUS.

G-PLUS is the result of the most innovative deposition technique PVD, by means of which it is possible to carry out coatings having high features through vacuum condensation of vapours obtained with physical factors on the surface to be coated. In the G-PLUS case, a physical reaction among zirconium ions (ZrN) which are deposited on the brass surface previously nickel and chromium plated is foreseen. The vapours are originated by means of vacuum discharge pressure between a cathode, that is the source of vapours and the chamber in which the entire process takes place. The handles and coordinates treated with G-PLUS have characteristics which are vastly superior compared to what obtainable by means of traditional treatments. G-PLUS underwent severe laboratory tests which allow us to certify:

G-PLUS underwent severe laboratory tests which allow us to certify:

- 100% adhesion according to UNI-ISO 425415 Norm.
- No alterations after a 1000 hour accelerated resistance to light test according to UNI 9397 norm.
- No indentation was caused by using hydrochloric, sulphuric, nitric, oxalic, acetic and citric acids, caustic soda and potassium hydroxide, cyanide and alkaline and hot degreasing.

The protective results of G-PLUS treatment allow, even to the most demanding customers, to obtain handles and coordinates with a hardened surface which can be compared to steel, which is resistant to external atmospheric agents and which can be placed externally even in saline fog. Thanks to the inalterability of protection, the brass colour brightness doesn't change and an unlimited guarantee due to protection which goes even beyond the limit guarantee foreseen by the law. G-PLUS a protection unlimited guaranteed for people who want beautiful long lasting handles.

# Avvertenze

## PRECAUZIONI PER INSTALLATORI ED UTILIZZATORI FINALI

**Protezione dall'acido tannico:** nelle finestre e porte-finestre in legno di rovere o altre essenza con un elevato contenuto di tannino, assicurarsi che questo non possa evaporare dal legno. La guarnitura non deve avere contatto diretto con una superficie del legno non trattato.

**Protezione da sigillante:** non utilizzare mai sigillanti a reticolazione acetica o contenenti altre sostanze aggressive, ad esempio acido formico o acetico, composti di ammoniaca, aldeide, fenoli, cloro, tannino ecc., perché sia il contatto diretto con il sigillante che i vapori di queste sostanze possono aggredire la superficie dei particolari.

Durante i lavori in genere, demolizione, ristrutturazione, realizzazione di intonaci e tinteggiatura, riparare le guarniture (comunque tutti i nostri prodotti) dal contatto con polveri, calce, intonaco, tempere e smalti vari. Fare aerare bene il locale prima di togliere le protezioni, il consiglio se possibile sarebbe di montare le guarniture dopo aver eseguito i lavori e dopo essersi assicurati che il locale sia stato ben aerato.

**Pulizia e protezione da detergenti aggressivi contenenti acidi:** pulire le guarniture esclusivamente con panno morbido e detergenti a pH neutro diluito. Non usare mai detergenti o abrasivi aggressivi contenenti acidi. Questi potrebbero danneggiare le guarniture.

La non osservanza delle suddette indicazioni può causare danni irreparabili al prodotto.

# Warnings

## PRECAUTIONS FOR INSTALLATION AND CONSUMERS

**Tannic acid protection:** in the windows and glass doors in oak or other trees with a high tannin content, make sure that this can not evaporate from the wood.

The crank should not have direct contact with a surface of untreated wood.

**Sealant protection:** Do not use any sealant acetic or other aggressive substances such as formic acid, acetic acid, ammonia compounds, aldehyde, phenol, chlorine, tannin etc., for a direct contact with the sealant, the vapors of these substances can damage the finishings of the products.

During general maintenance, demolition, renovation, plastering and painting, repairing the cranks (though all of our products) from contact with dust, lime, plaster, tempera and various glazes.

Make sure the rooms are ventilated enough before removing the protections. The best advice if possible is to mount the cranks after performing other works and after making sure that the premises was well aerated.

**Cleaning and protection from detergents containing acids:** clean the cranks only with soft cloth and neutral pH detergent diluted. Never use harsh or abrasive cleaners containing acids.

These could damage the crank.

The non-observance of these instructions may cause irreparable damage to the product.

# Condizioni Generali di Vendita

## PREZZI

I prezzi indicati in questo listino sono espressi in euro, iva esclusa e si intendono franco fabbrica. Ghidini Pietro Bosco Srl si riserva in qualunque momento di modificare i prezzi presenti in questo listino, facendo il possibile per comunicare per tempo eventuali aggiornamenti. I prezzi indicati non sono vincolanti e possono essere soggetti a variazioni.

## ARTICOLI

Tutti gli articoli presentati con il precedente Listino Illustrato 2019, ma non citati in questa edizione sono usciti di produzione, pertanto eventuali ordini in corso saranno evasi fino ad esaurimento delle scorte. Ogni variante rispetto agli articoli a listino è da considerarsi prodotto speciale per il quale, di volta in volta, è necessario richiedere fattibilità, quantità minima, prezzo. La fornitura di prodotti speciali a richiesta è subordinata all'accettazione da parte del committente della relativa conferma d'ordine. La Casa si riserva il diritto di approvare modifiche agli articoli e variazione dei prezzi senza preavviso. Per prodotti speciali approntati a richiesta non si accettano resi per alcun motivo.

## MODELLI, DIMENSIONI, PESI

Ghidini Pietro Bosco Srl si riserva, in qualunque momento e senza preavviso, di modificare e/o sopprimere gli articoli del presente catalogo. Dati, misure o schemi su questo catalogo hanno solamente carattere informativo, non sono vincolanti e possono essere soggetti a variazioni.

## ORDINI

Verranno accettati solo ordini per iscritto; ordini pervenuti telefonicamente o verbalmente non saranno ritenuti validi. Con la trasmissione dell'ordine il cliente accetta tutte le condizioni elencate di seguito. L'ordine è vincolante per il cliente, mentre impegna Ghidini Pietro Bosco Srl solo dopo espressa accettazione. Non possono essere effettuati annullamenti senza l'accordo scritto di Ghidini Pietro Bosco Srl, che si riserva comunque di applicare oneri e spese che ne derivino.

Il minimo importo netto merce fatturabile è di € 200,00.

## TERMINI DI CONSEGNA

I tempi di consegna dell'ordine decorrono dalla data della nostra conferma salvo diversa stipulazione e non potranno in nessun luogo dare luogo ad indennizzo/risarcimento da parte di Ghidini Pietro Bosco Srl. I termini di consegna indicati nell'ordine sono da intendersi puramente indicativi e non vincolanti per Ghidini Pietro Bosco Srl, che non sarà responsabile di eventuali ritardi. In particolare non è responsabile per ritardata o omessa consegna, totale o parziale, imputabile a cause di forza maggiore, o ad eventi che siano fuori dal suo controllo, quali, in via esemplificativa, scioperi aziendali e di trasporto, mancanza di energia elettrica, mancata o ritardata ricezione di materie prime, ecc. Ghidini Pietro Bosco Srl si riserva il diritto di evadere l'ordine anche con spedizioni parziali.

## DATI IDENTIFICATIVI DEL CLIENTE

Il cliente è responsabile della comunicazione dei propri dati fiscali forniti in base alla legislazione vigente (Ditta, Ragione sociale, Sede, Partita IVA). I dati del cliente saranno custoditi ed elaborati per adempimenti degli obblighi di Legge. Ogni altro utilizzo dovrà essere espressamente autorizzato dal cliente.

## SPEDIZIONI

La merce viaggia a rischio e pericolo del committente franco stabilimento Ghidini Pietro Bosco Srl che declina comunque ogni responsabilità per ritardi o rotture verificatesi durante il trasporto. Spetta al committente verificare la merce in arrivo e contestare eventuali danni direttamente al trasportatore, anche se questi è stato scelto da Ghidini Pietro Bosco Srl, entro 8 giorni dal ricevimento della stessa mediante raccomandata A.R. Si accettano eventuali reclami sulla quantità di pezzi ricevuta al massimo entro 8 giorni dalla data di consegna.

## PAGAMENTO

I pagamenti devono essere effettuati direttamente a Ghidini Pietro Bosco Srl nei termini pattuiti. Trascorsi i termini Ghidini Pietro Bosco Srl provvederà senza alcun preavviso all'addebito degli interessi di mora stabiliti per Legge, che decorreranno dal giorno immediatamente successivo alla scadenza del debito. Il mancato rispetto dei pagamenti pattuiti, comunicati per iscritto nelle conferme d'ordine, può comportare, a discrezione dell'azienda, il blocco degli ordini in corso fino a pagamento avvenuto e la sospensione delle ulteriori forniture anche se già accettate. I pagamenti dei prodotti già consegnati non saranno subordinati al completamento dell'ordine. Nessun pagamento potrà essere differito nel caso di contestazioni salvo accordi diversi. Fino al momento in cui Ghidini Pietro Bosco Srl non abbia ricevuto il pagamento del valore complessivo dei prodotti, gli stessi rimarranno di esclusiva proprietà di Ghidini Pietro Bosco Srl.

## RESPONSABILITÀ

Non si accettano merci di ritorno se non rese in Porto Franco e preventivamente autorizzate da Ghidini Pietro Bosco Srl. Solo il materiale riscontrato difettoso da Ghidini Pietro Bosco Srl sarà sostituito gratuitamente senza nessun altro indennizzo per danni, spese o riparazioni. Ghidini Pietro Bosco Srl non si assume alcuna responsabilità e alcuna garanzia è prevista per difetti e danni derivanti da installazione impropria o cattivo uso. È vietato agli acquirenti effettuare qualsiasi lavorazione che modifichi le caratteristiche originarie dei prodotti Ghidini Pietro Bosco Srl.

## CONTROVERSIE

Le forniture sono soggette alla Legge italiana. Per qualunque controversia è riconosciuta la sola ed esclusiva competenza del Foro di Brescia, Italia.

## TERMINI DI GARANZIA

Si certifica che i prodotti Ghidini Pietro Bosco Srl sono interamente prodotti in Italia nelle nostre Aziende, salvo dove espressamente indicato. Ogni articolo, stampato o fuso e lavorato a mano è unico ed irripetibile e le piccole differenze cromatiche, che possono riscontrarsi, rappresentano la garanzia più certa dell'artigianalità del prodotto. Eventuali imperfezioni e/o differenze nella forma, nelle finiture e nei materiali sono da attribuire alla tecnologia e/o alle operazioni manuali necessarie alla lavorazione del prodotto. L'inosservanza delle istruzioni di montaggio e/o una non cura nell'utilizzo dei prodotti Ghidini Pietro Bosco Srl possono causare il mal funzionamento per i quali si declina ogni responsabilità.

## CONSIGLI PER LA PULIZIA, LA CURA E LA MANUTENZIONE DEL PRODOTTO

Si consiglia di pulire i prodotti Ghidini Pietro Bosco Srl utilizzando solamente un panno asciutto o leggermente inumidito con acqua. Non utilizzare assolutamente alcun detergente chimico per non alterare l'efficacia del trattamento superficiale.

# General Terms and Conditions of Sales

## PRICES

Listed prices in this price list are expressed in Euros and are intended ex works. Ghidini Pietro Bosco Srl reserves the right to modify at any time the prices; every reasonable attempt will be done to provide adequate notice of price updates. Prices here indicated are not binding and subjected to possible variations.

## ITEMS

All items presented in the previous Illustrated Price List 2019 but not mentioned in this edition are discontinued; therefore, any outstanding orders will be fulfilled until stock is exhausted. Any variation from the listed items is considered a special product, for which feasibility, minimum quantity, and price must be requested on a case-by-case basis. The supply of requested special products is subject to the client's acceptance of the corresponding order confirmation. The Company reserves the right to approve modifications to items and price changes without prior notice. Returns are not accepted for special products prepared upon request, for any reason.

## MODELS, DIMENSIONS AND WEIGHTS

Ghidini Pietro Bosco Srl reserves the right, at any time, to change and/or to cancel the items of this catalogue. Information, size or drawings in this catalogue are only for information and are not binding.

## ORDERS

Orders are accepted only in written form; orders or modifications communicated verbally and/or by phone will not be valid. Customers accept and are aware that their order is subject to the following general sale terms and conditions. Ghidini Pietro Bosco Srl is not legally bound by an order until we have confirmed it in written form but the Customer is bound when he/she accepts it. No cancellation of the order is valid without written agreement from Ghidini Pietro Bosco Srl, which reserves the right to apply charges.

The minimum net invoiceable goods amount is €200.00.

## DELIVERY TERMS

Delivery time starts from the order confirmation date, unless otherwise agreed, Ghidini Pietro Bosco Srl will not recognize any indemnity or compensation. The order delivery terms are purely indicative and not binding for Ghidini Pietro Bosco Srl, which is not responsible for any delay. Ghidini Pietro Bosco Srl is not liable for delayed or skipped delivery in its totality or partiality, due to acts of God or other event out of its control, like for example labour or freight strikes, lack of electric energy, missed or delayed raw material receipt and so on. Ghidini Pietro Bosco Srl reserves the right to dispatch orders even with partial shipment.

## CUSTOMER INFORMATION

The Customer is responsible for all the identification information data requested by the legislation in effect (Company name, legal name, Address, VAT, etc.). All Customer's data will be kept and used in full compliance with the Italian Law. All other use must be specifically allowed by the Customer.

## DELIVERIES

Ordered goods will be at the Customer's risk from the moment of delivery so Ghidini Pietro Bosco Srl declines any responsibility for delays or damage caused during the shipment. The Customer is responsible for checking the delivered goods and reporting possible damage to the forwarder, even if chosen by Ghidini Pietro Bosco Srl, within 8 (eight) days from receipt by certified mail. The Customer is also responsible for checking the quantity of the delivered goods; claims about quantity will only be accepted within 8 (eight) days from receipt.

## PAYMENTS

Payments shall be made directly to Ghidini Pietro Bosco Srl in the manner and at the time agreed by the parties. In the event of failure to make the payment at the due date, the Customer will, with effect from the invoice date, be charged of interests and penalties. If the Customer is in default, Ghidini Pietro Bosco Srl shall have the right to defer shipment or any future order intake or delivery until such default is remedied or said credit reestablished to our satisfaction. No claim shall enable the customer to suspend payments. The payment of products already delivered shall not oblige Ghidini Pietro Bosco Srl to complete the order. In case of disagreements payments cannot be deferred, unless otherwise agreed. Until the receipt of payment for the total value of the goods ordered, Ghidini Pietro Bosco Srl will be and remain the sole and only proprietor of the goods.

## RESPONSABILITY

Ghidini Pietro Bosco Srl does not accept return of goods without prior approval, in all cases costs for goods returns must be borne by the Customer. Only faulty goods found by Ghidini Pietro Bosco Srl will be replaced free of charge without any other indemnity or refund for damage or repairs. Ghidini Pietro Bosco Srl is not responsible for any faulty goods which have been manipulated in a bad way. Any damage caused by improper installation or use is not covered by any guarantee. Customers are not authorized to rework Ghidini Pietro Bosco Srl products.

## CONTROVERSY

Orders are governed by the Italian Law. If the parties cannot reach amicable settlements, disputes shall be referred uniquely to the competent civil court in Brescia.

## WARRANTY

We certify with our complete and utmost corporate integrity that Ghidini Pietro Bosco Srl products are produced solely within our Italian manufacturing facilities, if not expressly indicated. Each piece of hardware, forged or cast is hand-crafted to perfect the uniqueness in design and finish. The guarantee of originality is due to the fact that the finish of each product is slightly different than the previous item. Any imperfections or differences in form, finishes and materials are to be attributed to the technology or manual operations necessary for processing the product. Failure to comply with the instructions and/or a lack of care in use may cause damages for which Ghidini Pietro Bosco Srl declines all responsibility.

## CLEANING SUGGESTIONS

In order to maintain the quality of the protective treatment and uniqueness of all finishes of Ghidini Pietro Bosco Srl products do not attempt to clean with detergents and/or chemicals. Hence, simply use a lightly water moistened cloth to clean the items.





# GHIDINI

Ghidini Pietro Bosco Srl  
Via Pietro Ghidini 32/34  
25060 Brozzo di Marcheno  
(BS) Italia  
P.iva 00553110982

[info@ghidini.com](mailto:info@ghidini.com)  
+3903089691

[ghidini.com](http://ghidini.com)

G